

Thank you for your purchase!

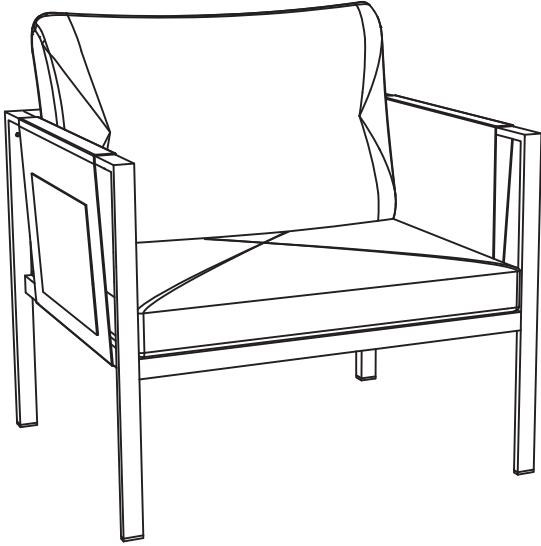

STEEL FRAME PATIO CHAIR WITH CUSHIONS

ASSEMBLY INSTRUCTIONS

Before You Begin:

Please identify all component parts and hardware pieces required before your begin. Carefully remove all of the components from the packaging and set aside for assembly. Assemble on a soft surface to prevent scratching during assembly.

Caution:

Tighten all components securely before use. Failure to do so may result in personal injury. DO NOT use any sharp objects to open plastic wrapped components as damage to product or components may result.





Warning:

- CHOCKING HAZARD -Small Parts. Adult Assembly Required.
- DO NOT ALLOW CHILDREN TO CLIMB ON FURNITURE

Serious or fatal crushing injuries can occur from furniture tipping over. You must install the Tipping Restraint Hardware with the unit to prevent the unit from tipping and causing any accidental injury, instability, death or damage. The tipping restraint is intended only as a safety measure, it is not a substitute for proper adult supervision.



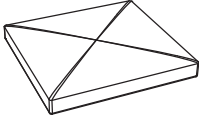
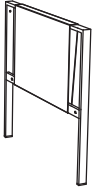
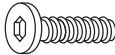
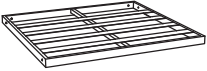

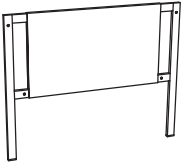
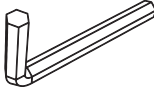
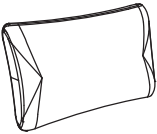

To help prevent furniture from tipping over it must be permanently attached to the wall. Anti-Tip Safety Wall Straps suitable the unit weight and wall materials (if not included) should be purchased and installed.

PARTS

Part	Image	Description	QTY	Part	Image	Description	QTY
A		Left Armrest	1x	F		Seat Cushion	1x
B		Right Armrest	1x	G		M6x30 Screw	8x
C		Seat	1x	H		Washer Ring	8x
D		Back	1x	I		Allen Key	1x
E		Back Cushion	1x				

STEPS



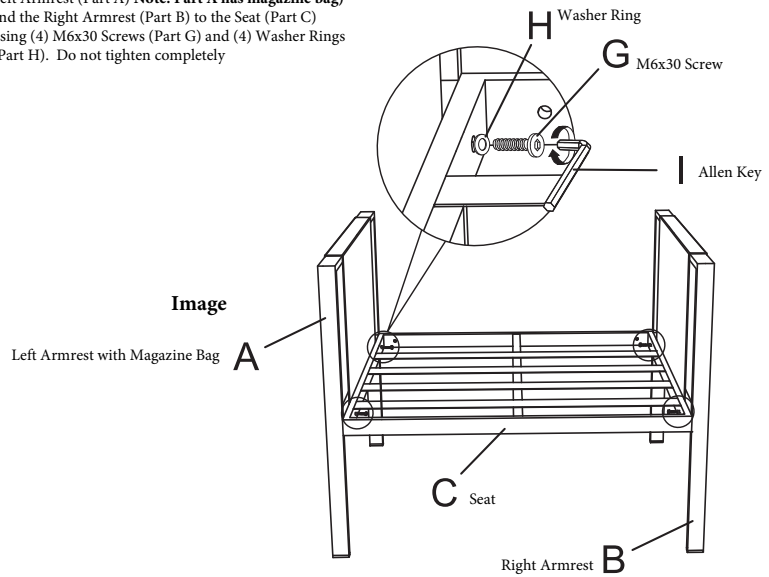

STEP 1 PARTS REQUIRED: Note**** Back Piece (Part D) is wider than A or B and is not used in Step 1

Part	Image	Description	QTY
A		Left Armrest	1x
B		Right Armrest	1x
C		Seat Part	1x
G		M6x30 Screw	4x
H		Washer Ring	4x
I		Allen Key	1x

STEP 1: From the inside of the frame, attach the Left Armrest (Part A) **Note: Part A has magazine bag** and the Right Armrest (Part B) to the Seat (Part C) using (4) M6x30 Screws (Part G) and (4) Washer Rings (Part H). Do not tighten completely





STEP 2 PARTS REQUIRED

Part	Image	Description	QTY
D		Back	1x
G		M6x30 Screw	4x
H		Washer Ring	4x
I		Allen Key	1x

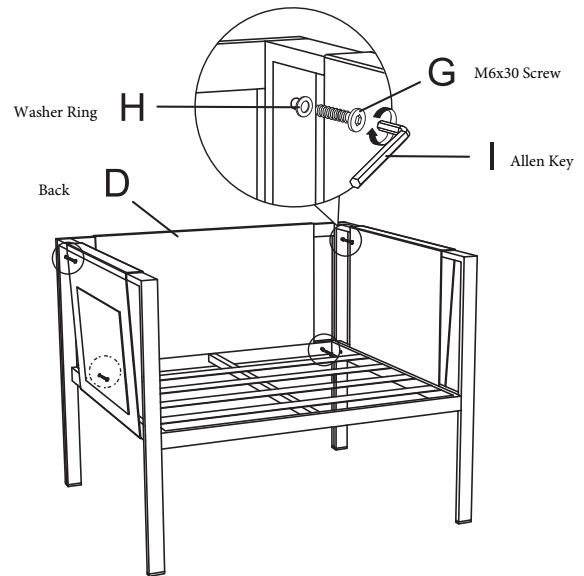
STEP 2: From the inside of the frame, attach Back (Part D) to the left and right armrests using (4) M6x30 Screws (Part G) and (4) Washer Rings (Part H). Securely tighten all screws.



STEP 3 PARTS REQUIRED

Part	Image	Description	QTY
E		Back Cushion	1x
F		Seat Cushion	1x

STEP 3: Add Seat Cushion (Part F) then add Back Cushion (Part E)

