

Folding Metal Computer Desk with Shelves



Dimensions	No. people	Assembly Time
Width: 120cm Depth: 60cm Height: 75cm		30 mins (approx.)

Important

- PLEASE READ THESE INSTRUCTIONS FULLY BEFORE STARTING ASSEMBLY
- PLEASE DO NOT THROW THE PACKAGING AWAY UNTIL YOU ARE SATISFIED WITH PURCHASE, GOODS NEED TO BE RETURNED IN ORIGINAL PACKAGING.

1

Assembly Instructions

Step1: Fix the 2 longest metal tubes **(D)** between the frames **(A)** and **(B)** with the large screws **(L)**.

(NOTE: the hole on the tube **(D)** close to the frame **(A)** side)

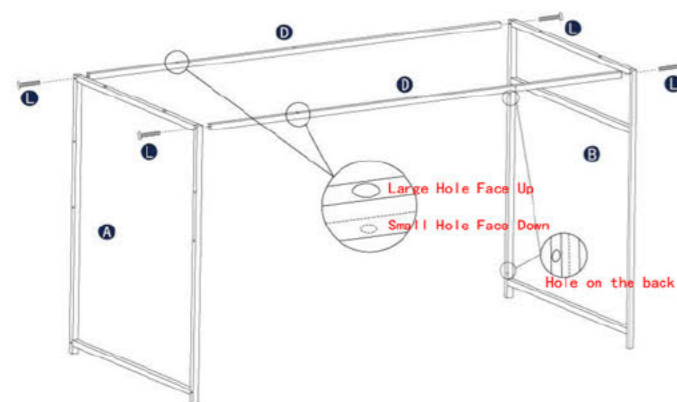
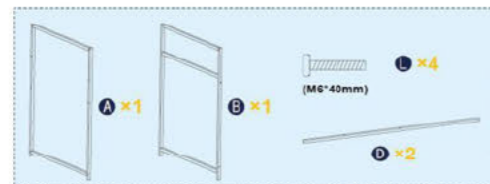

If you want to install the shelf on the right side, please refer to page 11

4

⚠ Safety and Care Advice

Important

- PLEASE READ THESE INSTRUCTIONS FULLY BEFORE STARTING ASSEMBLY
- PLEASE DO NOT THROW THE PACKAGING AWAY UNTIL YOU ARE SATISFIED WITH PURCHASE, GOODS NEED TO BE RETURNED IN ORIGINAL PACKAGING.

- Check you have all the components and tools listed on pages 3.
- Remove all fittings from the plastic bags and separate them into their groups.
- Keep children and animals away from the work area, small parts could choke if swallowed.
- Make sure you have enough space to lay out the parts before starting.
- Do not stand or put weight on the product, this could cause damage.
- Assemble the item as close to its final position (in the same room) as possible.
- Assemble on a soft, level surface to avoid damaging the unit or your floor.
- We do not recommend the use of power drill/drivers for inserting screws, as this could damage the unit. Only use hand screwdrivers.
- Dispose of all packaging carefully and responsibly.



Care and Maintenance

- Only clean using a damp cloth and mild detergent, do not use bleach or abrasive cleaners.
- From time to time check that there are no loose screws on this unit.
- This product should not be discarded with household waste. Take to your local authority waste disposal centre.

If kept outside please ensure in the winter months that the product is correctly covered or put away into a dry environment to prevent corrosion, weathering or damage.

If your product is not designed to be outside, we recommend that it is always kept indoors in a dry environment.

If you are unhappy with the product and wish to return it, please follow the retailer's returns procedure.

2

Assembly Instructions



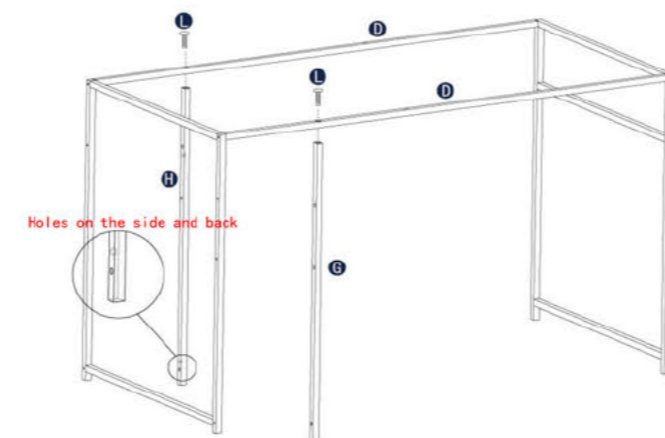













Step2: Fix the metal tube **(G)** and **(H)** on the tube **(D)** with large screws **(L)**.



5

Components - Panels

Please check that you have all the components listed below before constructing your item.

Part No	Description	Qty	Size (mm)	Images
A	Metal frame	1		
B	Metal frame	1		
C	Top board	1		
D	Metal tube	2		
E	Wooden board	2		
F	Metal tube	4		
G	Metal tube	1		
H	Metal tube	1		
I	Crossbar	2		
J	Small screws	5	M6 x 10mm	
K	Medium screws	14	M6 x 28mm	
L	Large screws	14	M6 x 40mm	
M	Nut	1		
N	Adjustable feet	6		
O	Hook	2		
P	L-wrench	1		

If you need help or have damaged or missing parts, please email aftersales@gpmfurniture.co.uk

3

Assembly Instructions

Step3: Fix the crossbar **(I)** on the tube **(B)** and **(H)**, use the screws **(J)**; Then fix the 2 pcs of crossbar with the nut **(M)**.

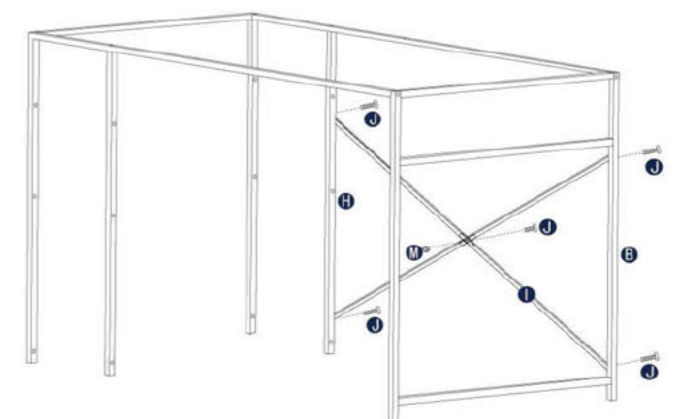

6

Assembly Instructions

Step4: Screw the adjustable feet **(N)** into the desk legs.

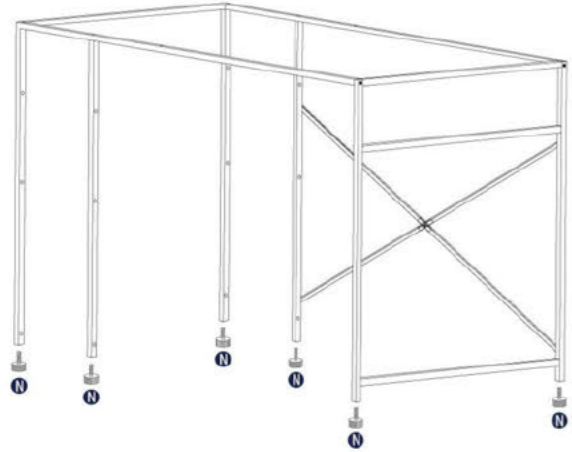

7

Assembly Instructions

Step5: Fix the wooden board **(E)** and the metal tube **(F)** together with the medium screws **(K)**.

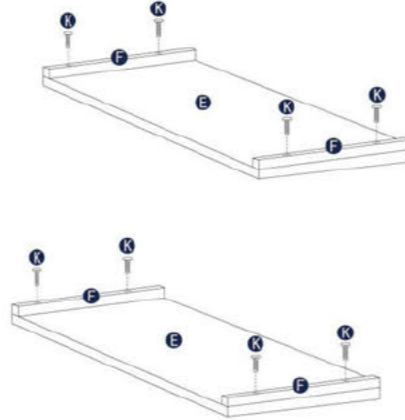
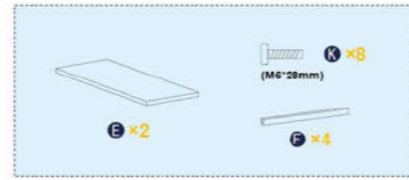

8

Assembly Instructions

Step6: Fix the wooden board in sequence between tubes **(A)** and **(G)** / **(H)** with screws **(L)**.

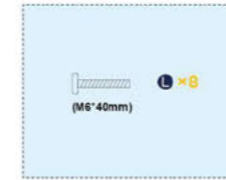

9

Assembly Instructions

Step7: Fix the top board **(C)** on the whole frame with screws **(K)**, put the hook **(O)** on the metal tube **(B)** if necessary.

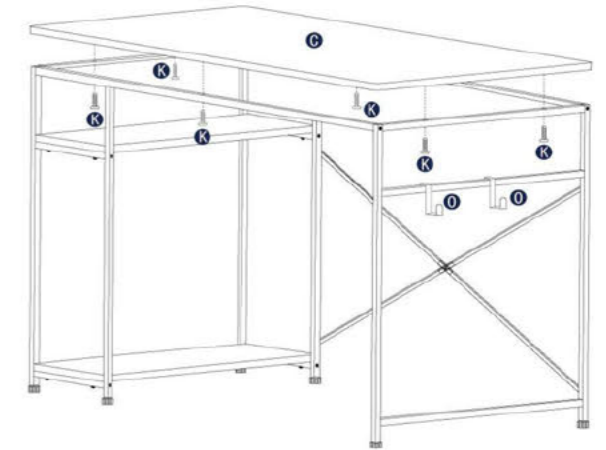
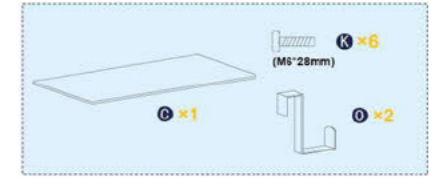

10

Assembly Instructions

If you want to install the shelves on the right side of the desk:



Step1: Place the frame **(B)** on the left and the frame **(A)** on the right;
Fix the 2 longest metal tubes **(D)** between the frames **(A)** and **(B)** with the large screws **(L)**.
(NOTE: the hole on the tube **(D)** close to the frame **(A)** side)

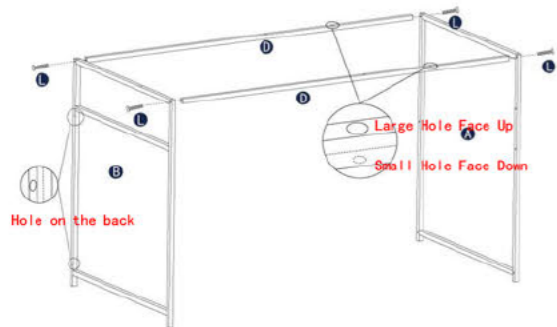

11

Assembly Instructions

Step2: Fix the metal tube **(G)** and **(H)** on the tube **(D)** with large screws **(L)**

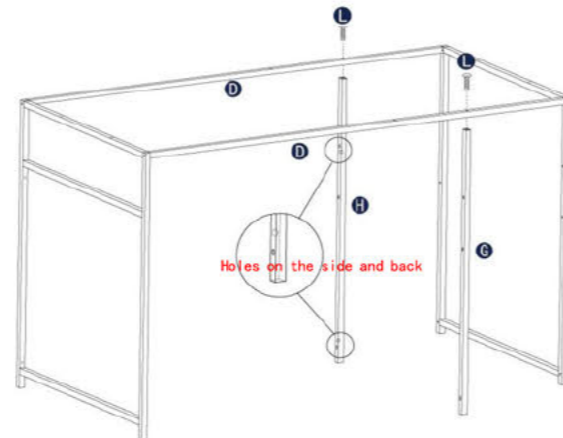

12

Step3: Fix the crossbar **(I)** on the tube **(B)** and **(H)**, use the screws **(J)**;
Then fix the 2 pcs of crossbar with the nut **(M)**.

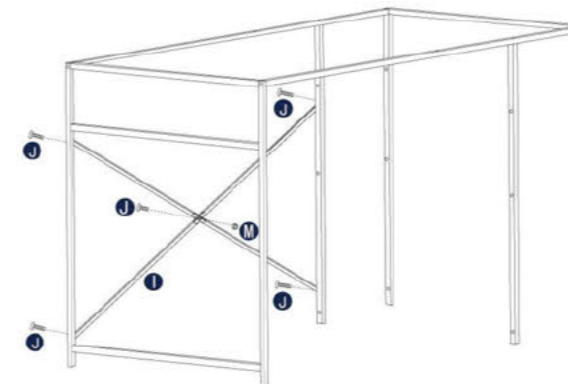
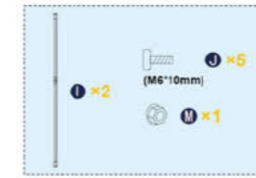

Please refer to pages 7-10 for other steps

13

Assembly Instructions

14