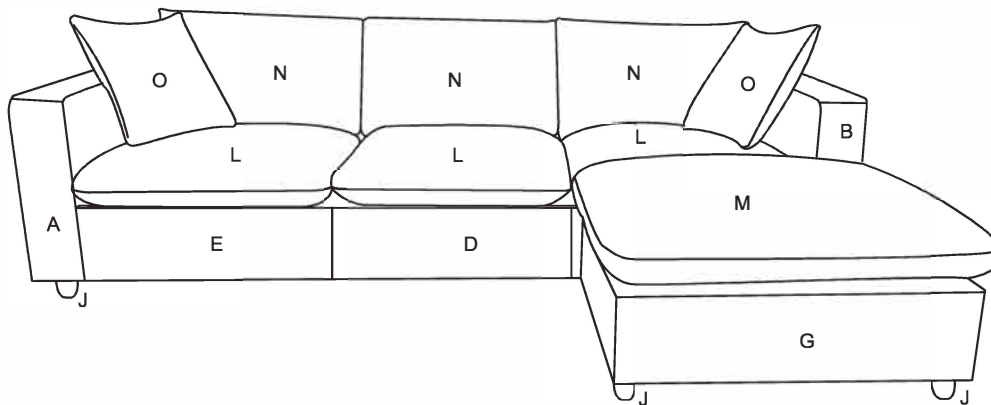


# ASSEMBLY INSTRUCTION

## Friendly Reminder:

- 1.This sofa is packed in 3 boxes. Please assemble it After all boxes are received.
- 2.As the cushions are all vacuum compressed,there will be some wrinkles. Please give your cushions up to 72 hours to reach its original size and the wrinkles will basically disappear.
- 3.Please do not open the compressed packags until your sofa frame is completely assembled.
















## Return & Warranty policy:







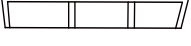





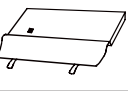



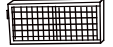

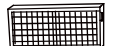


- We strive to offer the highest quality products,and we also try our best to satisfy each and every customer that orders from us with replacement parts or service as needed.
- If the item is damaged or defective, please take photos as evidence for replacements and refunds.
- Please do not return to store,contact the seller if you have any troubles with this product.

# ASSEMBLY INSTRUCTION







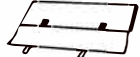





## HARDWARE LIST

NO	DESCRIPTION	SKETCH		NO	DESCRIPTION	SKETCH	QTY
①	Bolt M8X40		4 PCS	⑧	Bolt		6 PCS
②	Bolt M8X70		6 PCS	⑨	Allen key M6		1 PCS
③	Bolt M8X55		8 PCS	⑩	Gloves		2 PCS
④	Bolt M6X16		28 PCS	⑪	Slider		3 PCS
⑤	Bolt M6X35		4 PCS	⑫	Fastenings		2 PCS
⑥	Gasket Φ22		18 PCS	⑬	Metal fastenings		2 PCS
⑦	Spring gasket Φ22		18 PCS				

















## PARTS LIST

NO	DESCRIPTION	SKETCH	QTY	NO	DESCRIPTION	SKETCH	QTY
A	Armrest (left)		1 PCS	I1	Left seat frame		1 PCS
B	Armrest (right)		1 PCS	I2	Middle seat frame		1 PCS
				I3	Right seat frame		1 PCS
C1	Right tailgate		1 PCS	K	Backrest cover		1 PCS
C2	Left tailgate		1 PCS				
D	Middle front baffle		1 PCS	L	Seat cushion		3 PCS
E	Left front baffle		1 PCS	M	Ottoman cushion		1 PCS
F	Right front baffle		1 PCS	N	Backrest cushion		3 PCS
G	Ottoman frame		1 PCS	O	Pillow		2 PCS
H1	Left back frame		1 PCS	P	Supporting leg		4 PCS
H2	Right back frame		1 PCS				
J	Leg		8 PCS	Q	Plastic washer		8 PCS

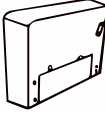
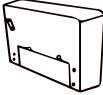
# PARTS LIST

NO	DESCRIPTION	SKETCH	QTY
I1	Left seat frame		1
I2	Middle seat frame		1
I3	Right seat frame		1
H1	Left back frame		1
H2	Right back frame		1
K	Backrest cover		1
D	Middle front baffle		1
E	Left front baffle		1
F	Right front baffle		1
C1	Right tailgate		1
C2	Left tailgate		1
M	Ottoman cushion		1
	Assembly instruction		1





**Hardwares**

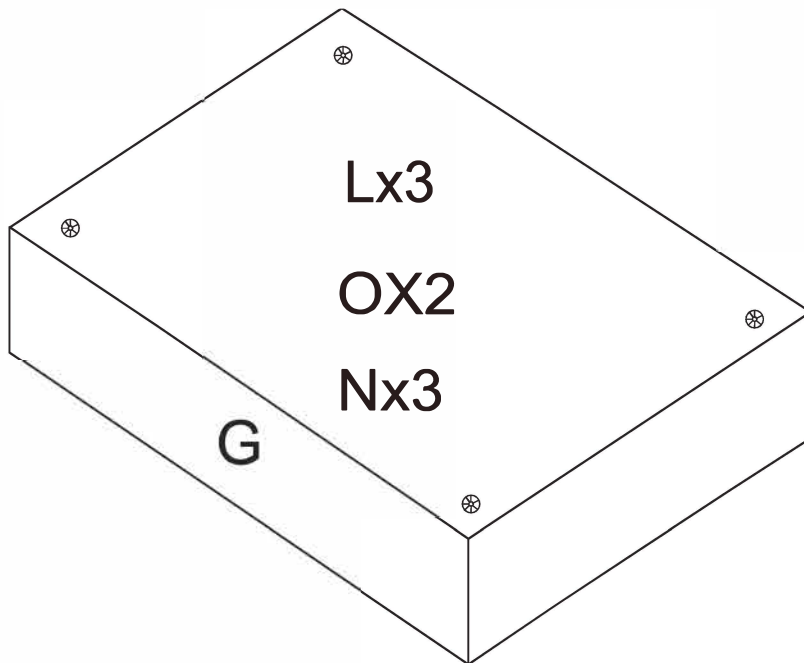
① X4	② X6	③ X8	④ X28	⑤ X4	⑥ X18	⑦ X18	⑧ X6	⑨ X1	⑩ X2
									
⑪ X3	⑫ X2	⑬ X2	J x8	Q x8	P X4				
					 <small>Supporting leg</small>				

## PARTS LIST

NO	DESCRIPTION	SKETCH	QTY
A	Armrest (left)		1
B	Armrest (right)		1



# PARTS LIST

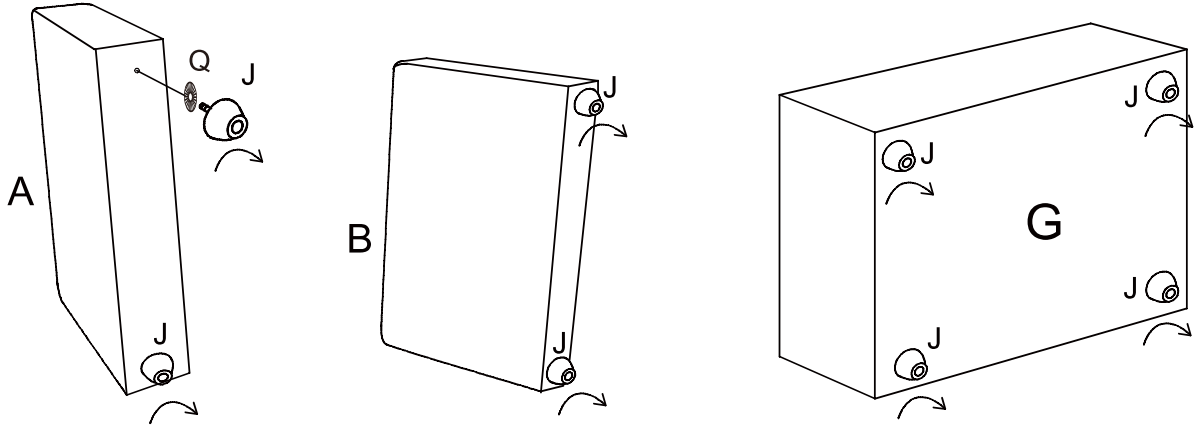
NO	DESCRIPTION	SKETCH	QTY
G	Ottoman frame		1
N	Backrest cushion		3
L	Seat cushion		3
O	Pillow		2



**DIAGRAM1:**





Tighten the Left armrest (Part A) and Right armrest (Part B), Otoman frame (Part G) with 8 Legs (Part J) and 8 Plastic washers (Part Q) in a clockwise direction.

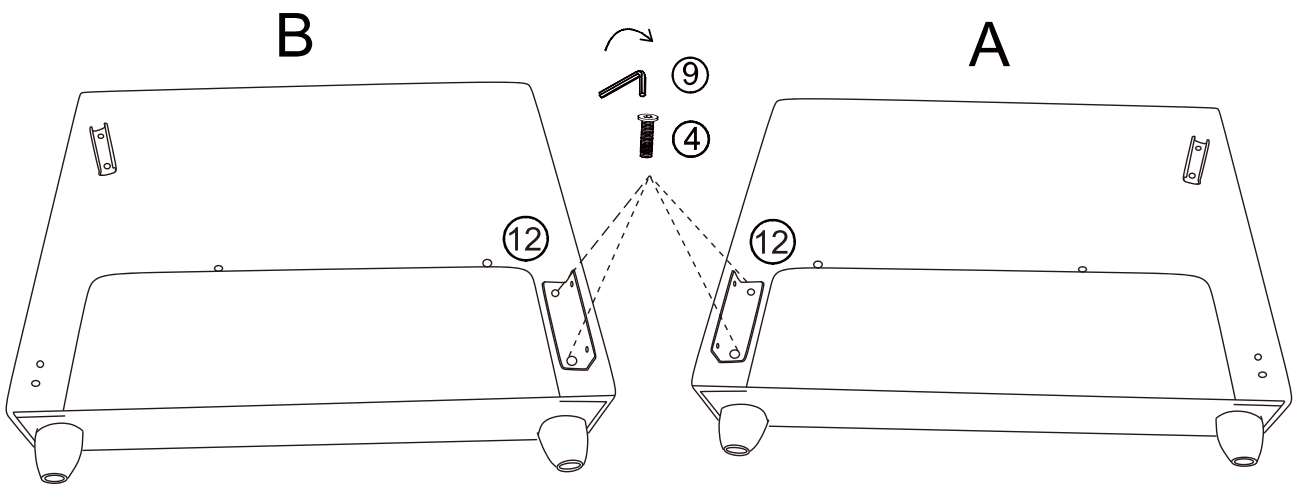
J		8 PCS
Q		8 PCS



**DIAGRAM2:**



1. Please wear gloves before installation.  
 2. Connect the Left armrest (Part A) and Right armrest (Part B) with Fastenings (Hardware 12) and 4 Bolts M6x16 (Hardware 4) by Allen key M6 (Hardware 9)

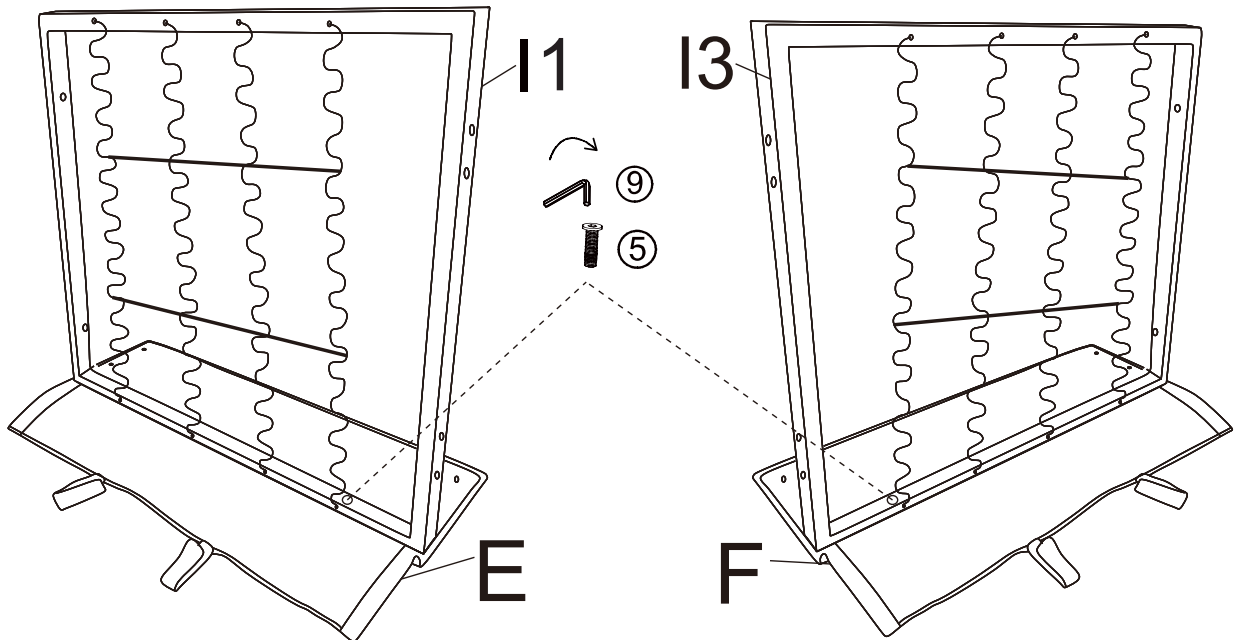
⑫		2 PCS
⑩		2 PCS
④		4 PCS
⑨		1 PCS



**DIAGRAM3:**



Connet Left seat frame(Part I1)and Right seat frame I3 to Left front baffle(Part E )and Right front baffle (Part F)with 2 Bolts M6x35 by Allen ken M6(Harewear 5+9).

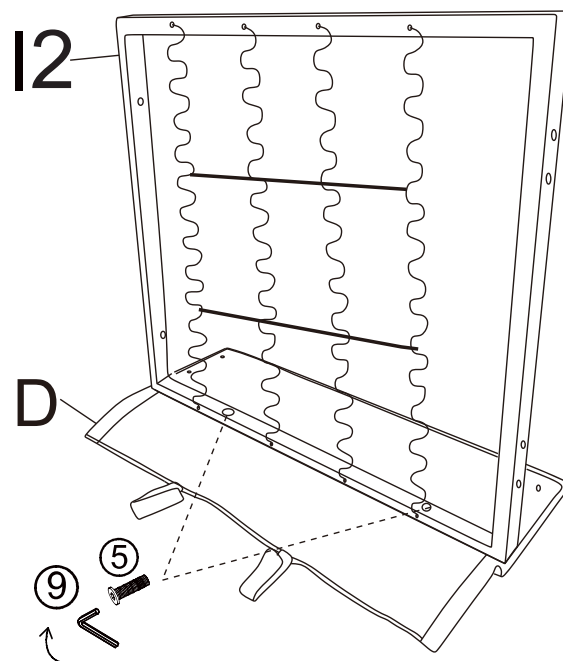
⑤		2 PCS
⑨		1 PCS



**DIAGRAM4:**





Connet Middle seat frame (Part I2)and Middle front baffle(Part D)with 2Bolts M6x35 byAllen ken M6(Harewear 5+9).

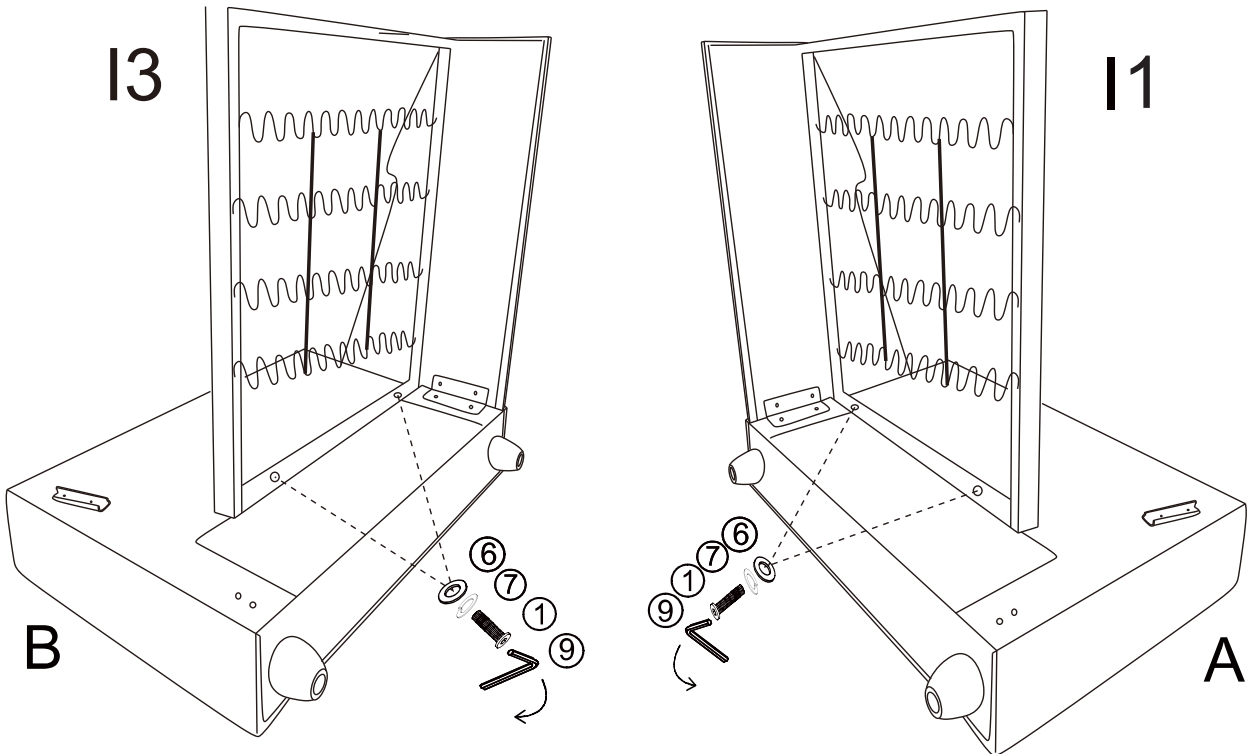
⑤		2 PCS
⑨		1 PCS



**DIAGRAM5:**



Attach the Left seat frame (Part I1) and Right seat frame (Part I3) on Left armrest (Part A) and Right armrest (Part B), with 4 Bolts M8x40 (Hardware 1) and 4 Gasket  $\Phi$ 22 (Hardware 6), 4 Spring gaskets  $\Phi$ 22 (Hardware 7) by Allen key M6 (Hardware 9).

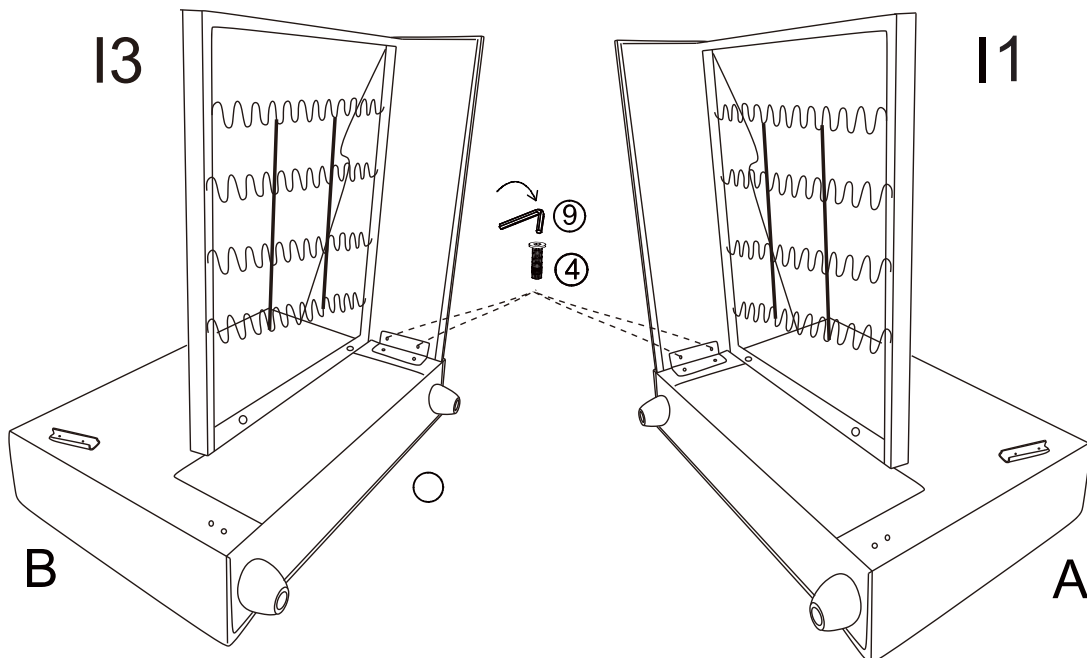
①		4 PCS
⑨		1 PCS
⑥		4 PCS
⑦		4 PCS



**DIAGRAM6:**






Attach the Left seat frame (Part I1) and Right seat frame (Part I3) on Left armrest (Part A) and Right armrest (Part B) with 4 Bolts M6x16 (Hardware 4) by Allen key M6 (Hardware 9).

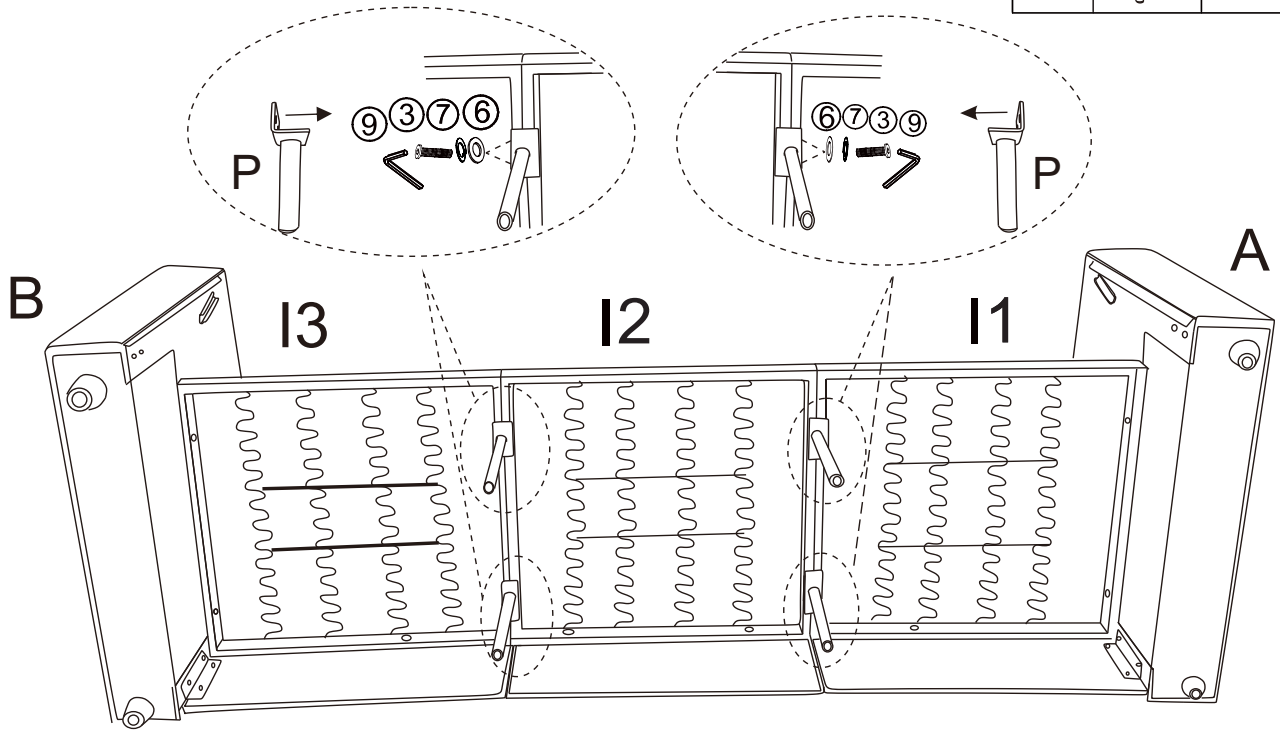
④		4 PCS
⑨		1 PCS



**DIAGRAM7:**




Secure the 4 Supporting legs (Part P) to the Seat frame (Part I1 and I2 ,I3) with 8 Bolts M8x55 and 8 Gaskets  $\Phi$ 22, 8 Spring gaskets  $\Phi$ 22(Hardware 6+7) by Allen key M6 (Hardware 9).

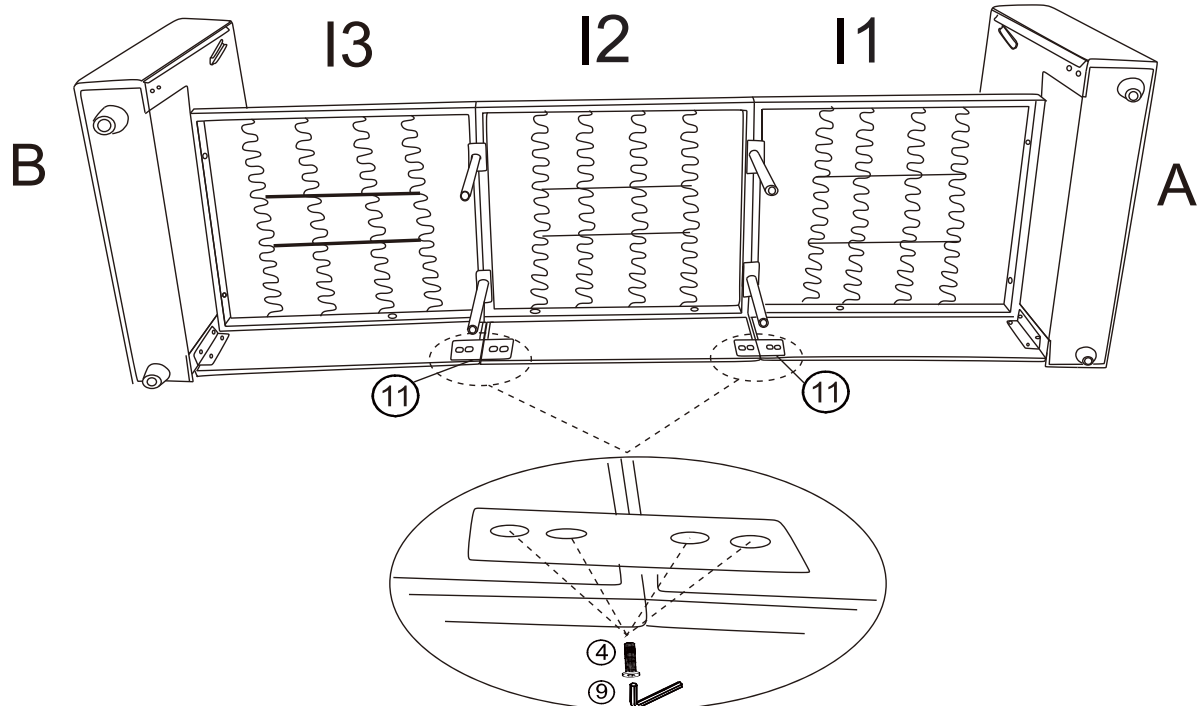
③		8 PCS
⑨		1 PCS
⑥		8 PCS
⑦		8 PCS
P		4 PCS



**DIAGRAM8:**






Secure the Slider (Hardware11) to the Seat frame (Part I1 and I2 ,I3) with 8 Bolts M6x16 by Allen key M6 (Hardware 4+9).

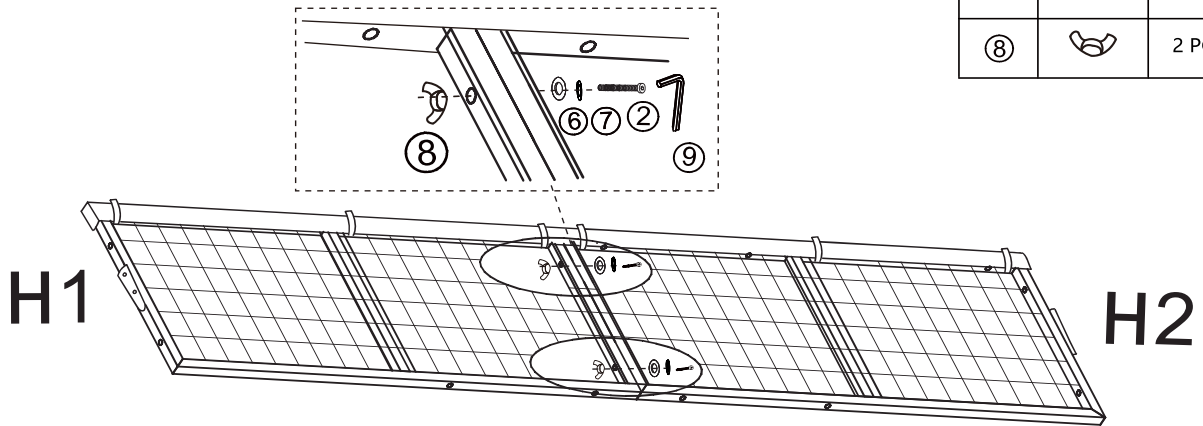
④		8 PCS
⑨		1 PCS
⑪		2 PCS



**DIAGRAM9:**

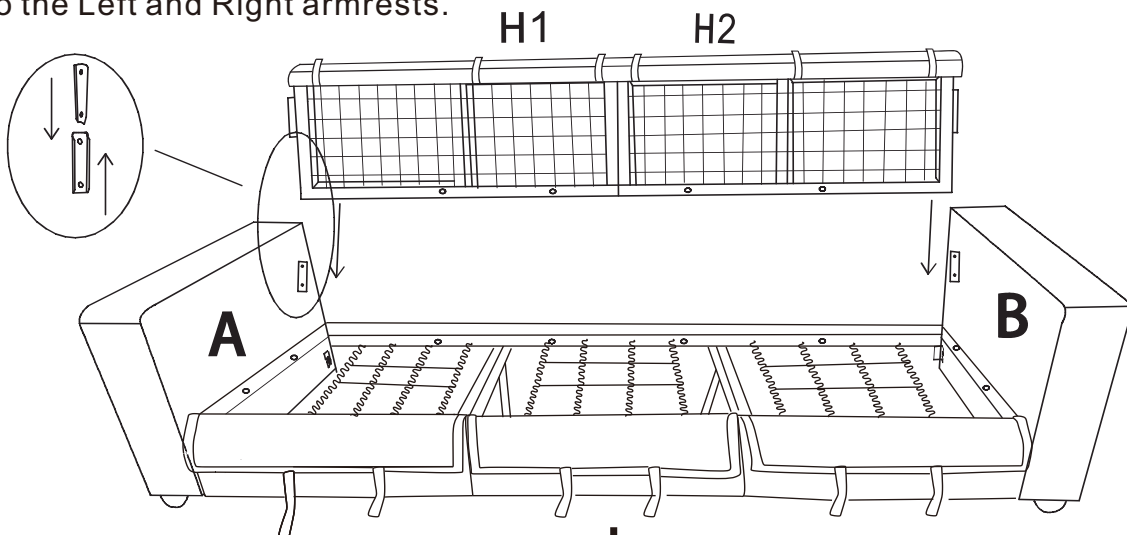
After opening the rack with Left back rest H1 and Right back rest H2. Use the 2 Bolts M8x70 and 2 Gaskets  $\Phi 22,2$  Spring gaskets  $\Phi 22,2$  Bolts(Hardware 2+6+7+8) to connect H1 and H2 by Allen key M6(Hardware 9).

②		2 PCS
⑨		1 PCS
⑥		2 PCS
⑦		2 PCS
⑧		2 PCS

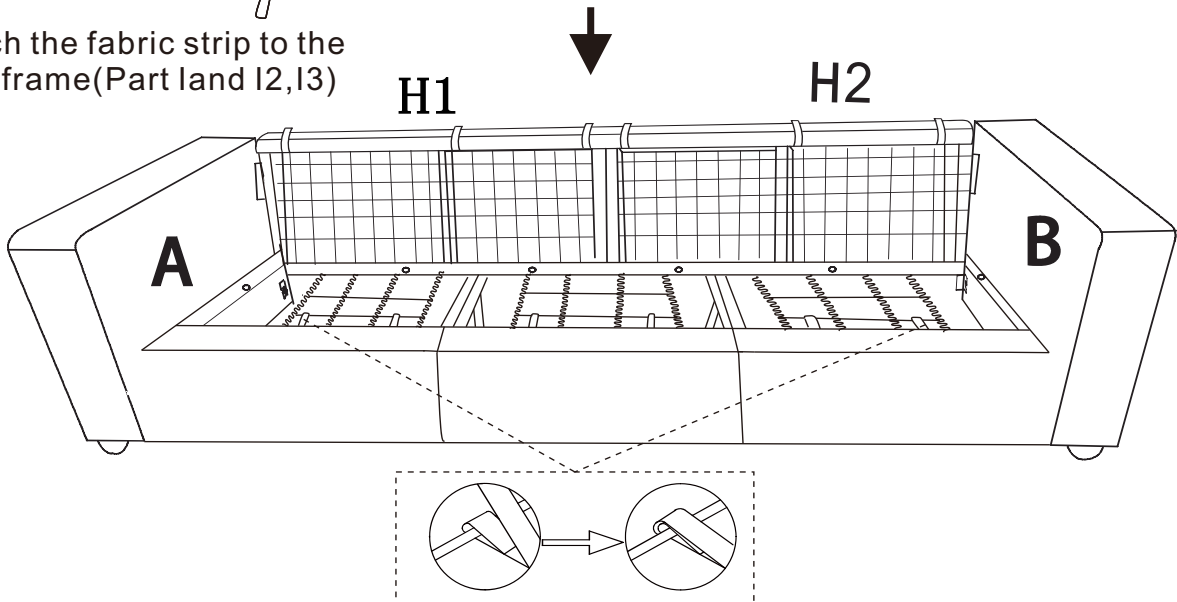


**DIAGRAM10:**

Align Back frame(Part H1anH2)position behind Left armrest and Right armrest (PartA+B ),and hang it as shown in the figure,insert the Backframe(Part H1anH2) into the Left and Right armrests.








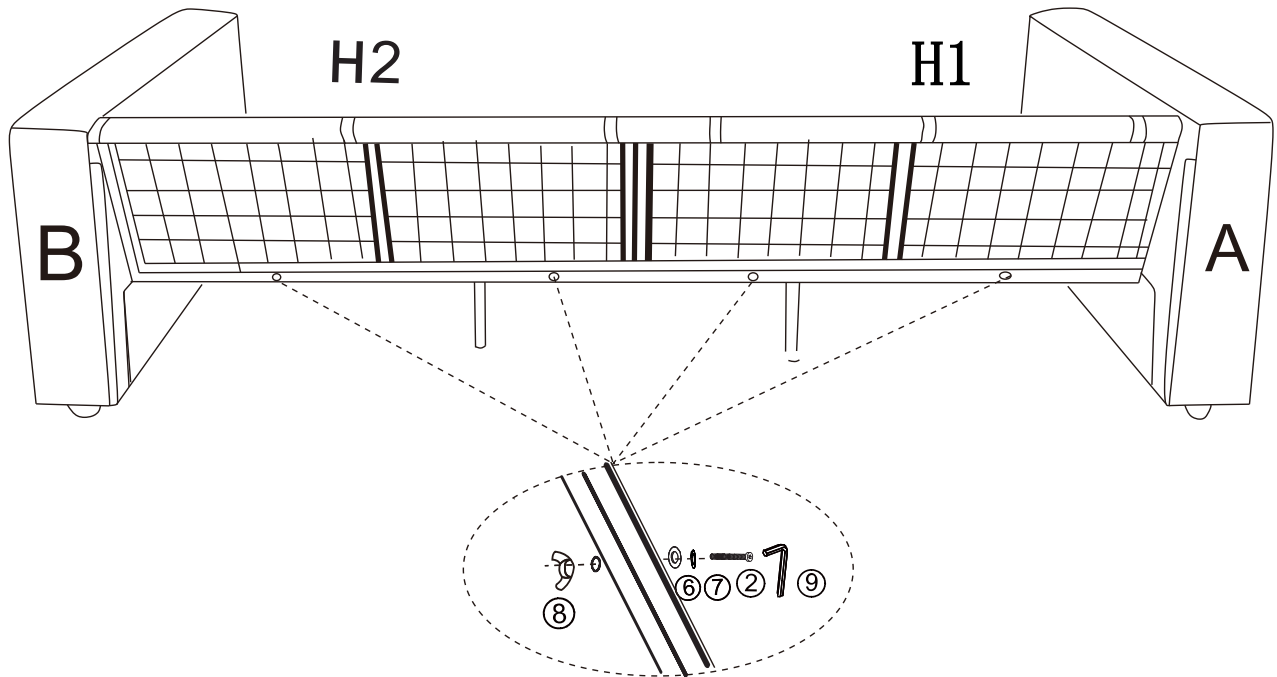
Attach the fabric strip to the Seat frame(Part land I2,I3)



**DIAGRAM11:**





Connect Back frame(PartH1 and H2 )with Seat frame (Part I1and I2,I3)with 4 Bolts M8 \*70 and 4 Gaskets  $\Phi$ 22, 4 Springgaskets  $\Phi$ 22,4 Bolts(Hardware2+6+7+8)by Allen key M6(Hardware 9).

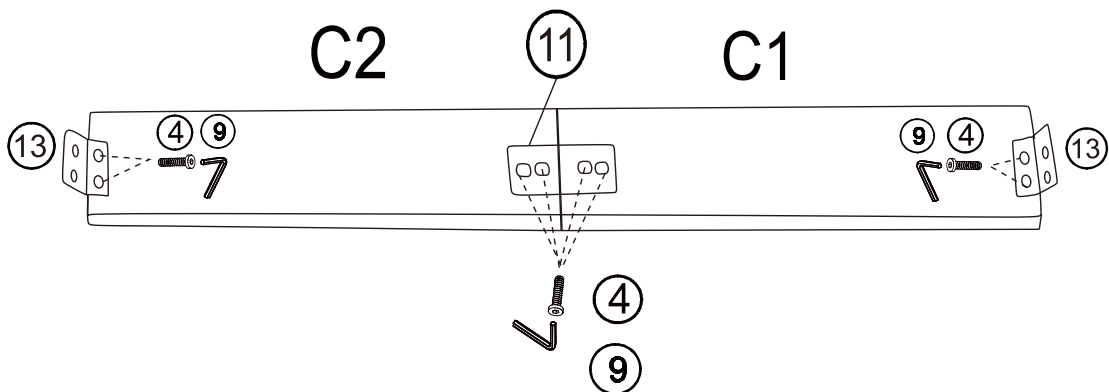
②		4 PCS
⑨		1 PCS
⑥		4 PCS
⑦		4 PCS
⑧		4 PCS



**DIAGRAM12:**



1.Fasten Right tailgate and Left tailgate (PartC2+C1)with 4 BoltsM6x16 (Hardware 4) through Slider(Hardware11) by Allen key M6(Hardware9).  
2.Fasten the 2 Metal fastenings(Hardware13)to C1 and C2 with 4 Bolts M6x16 by Allen key M6(Hardware 4+9).

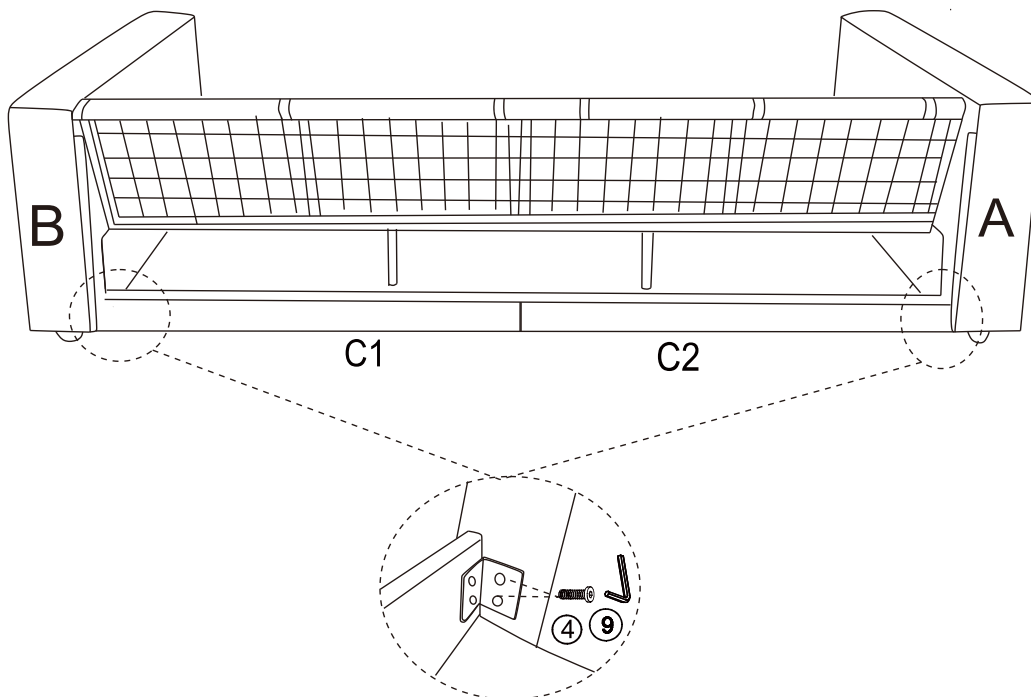
⑪		1 PCS
④		8 PCS
⑨		1 PCS
⑬		2 PCS



**DIAGRAM13:**

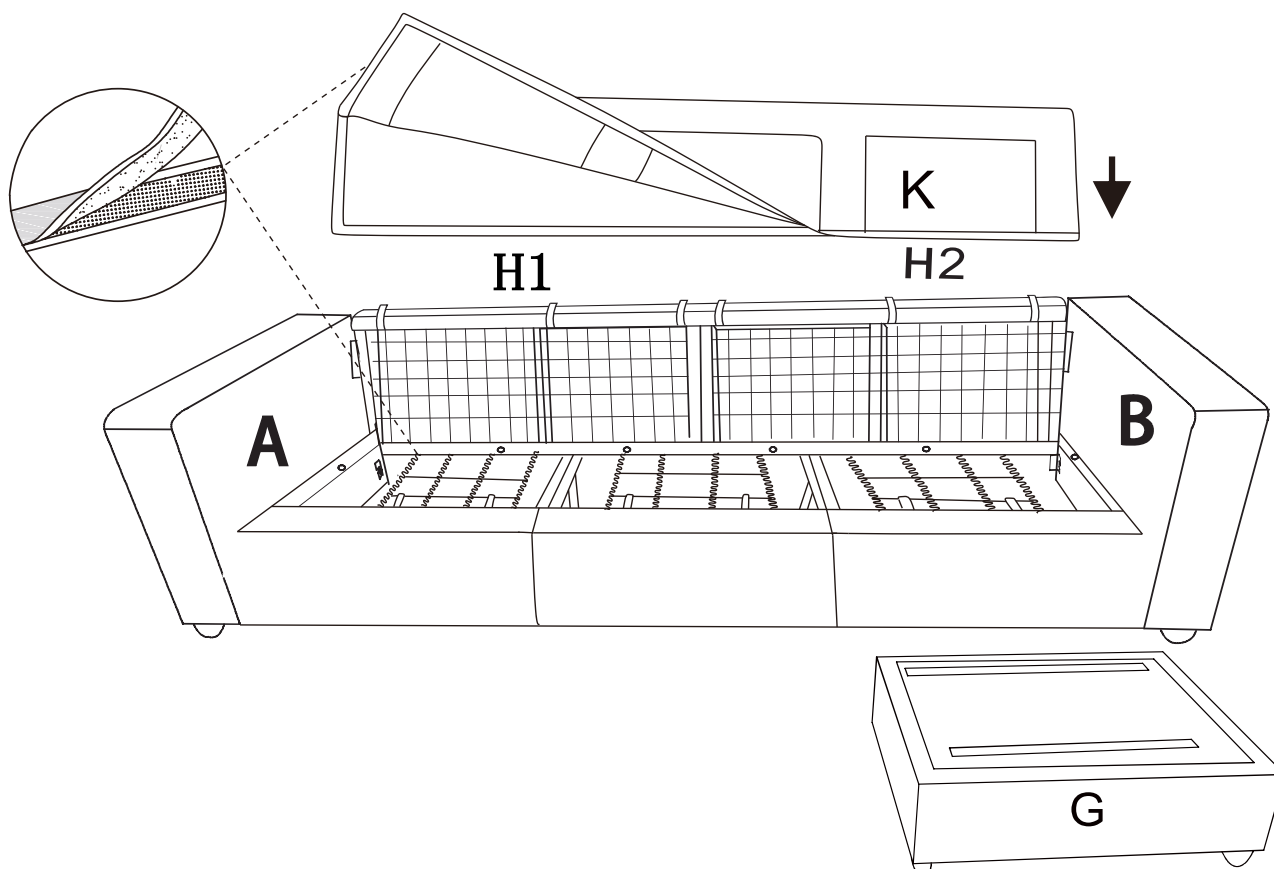
Attach the Right tailgate and Left tailgate(Part C1+C2) to the Right armrest and Left armrest (Part B+A) with 4 Bolts M6x16 (Hardware 4)by Allen key M6(Hardware9).

④		4 PCS
⑨		1 PCS

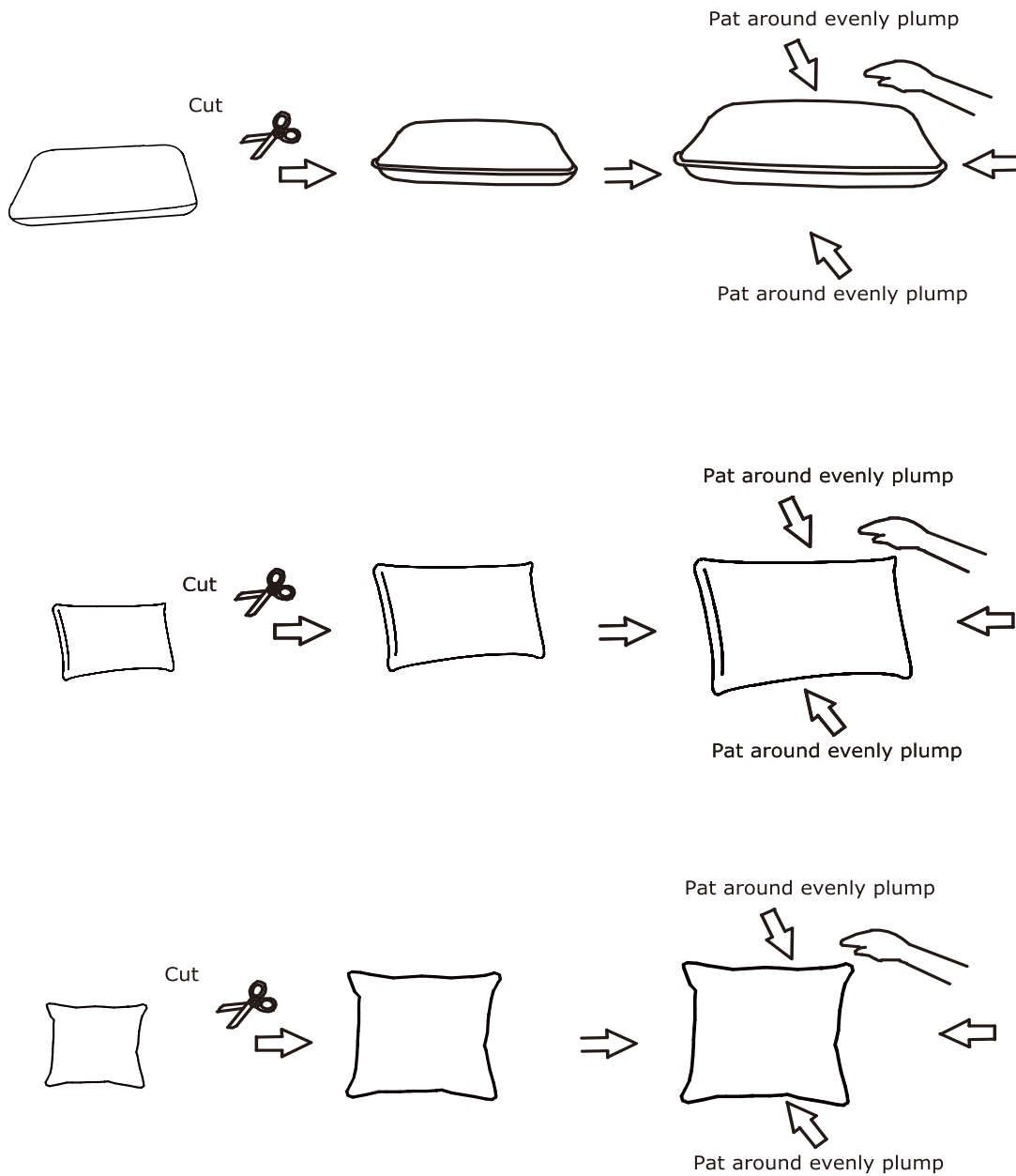


**DIAGRAM14:**

Place the Backrest cover(Part K) over the Back frame(Part H1and H2).  
Pasting the Backrest cover to the Seat frame(Part I1and 12,13).



Your cushions come vacuum packed and sealed for shipping. To restore the cushion's original shape, follow the steps below. After packing up, place them somewhere dry and ventilated. After about 72 hours it can be restored to its best-use condition.



Uneven Fabric is a normal phenomenon that the first time you open it, the fabric is uneven. Because the fabric is easy to crease after long time transport in vacuum compression. You can use an iron to smooth it out, have a try!

DIAGRAM15:

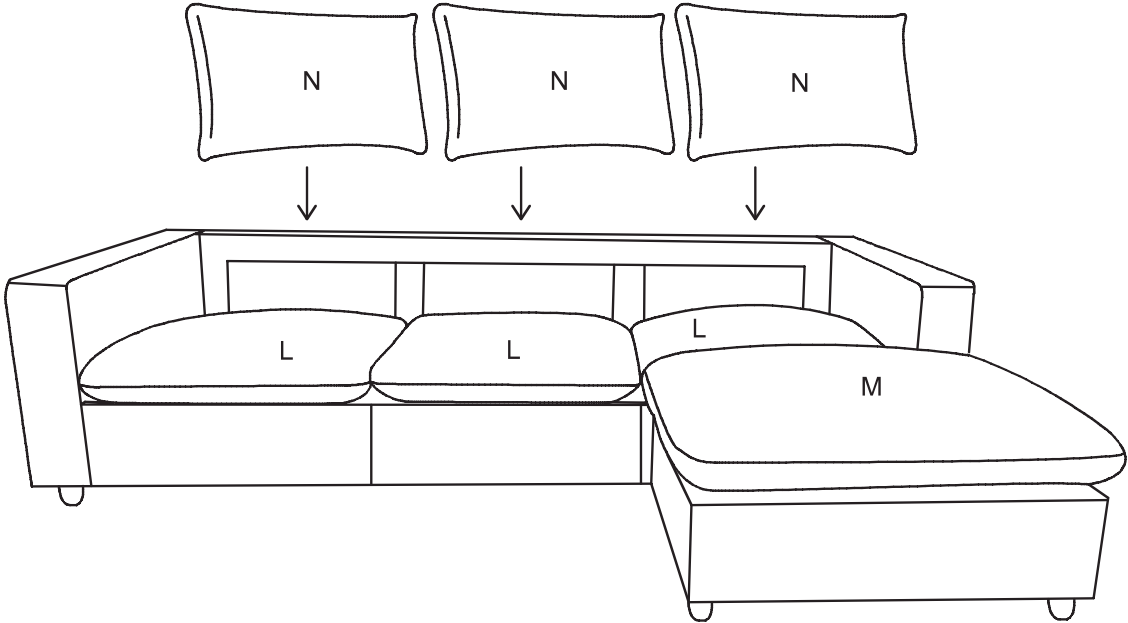


DIAGRAM16:

