







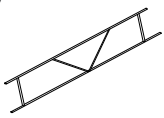

Components

a  x 2	b  x 2	c  x 2	d  x 1	e  x 1
f  x 2	g  x 1	j  x 1	k  x 2	1  M6x25 x 19
2  x 6	3  x 2	4  M6x10 x 8	5  M6x40 x 4	6  M6x30 x 2

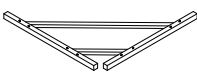
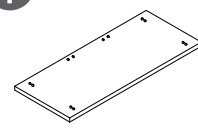
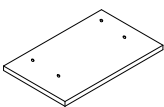
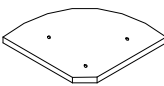
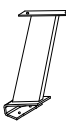
If you need any help or have damaged/missing parts, please contact us.

Important Assembly Advice

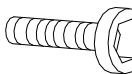
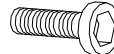
1. Parts of assembly will be MUCH EASIER with 2 people.

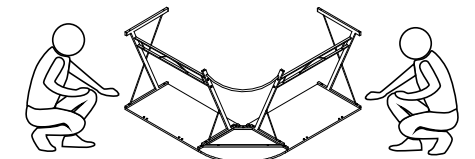

2. Before assembly: Lay out all parts on the opened carton. Identity tagged components and count them before assembly. Notice: Make sure correct screws are used for corresponding components.

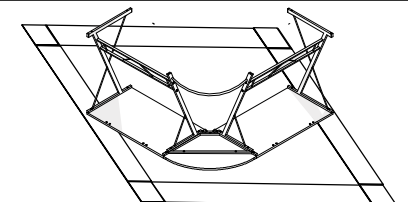

3. Please keep a mild tightness on all the screwing during assembly. After the whole desk is assembled, firmly tighten all the screws.

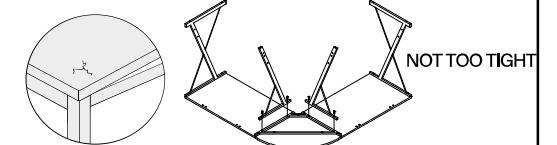

*** Only 1 Shelf included**

Monitor shelf can be moved arbitrarily and placed where you like, you can get to maximize your desktop space.

Assembly Instructions

1. Fix frame **a** and **e** on boards **f** and **i**

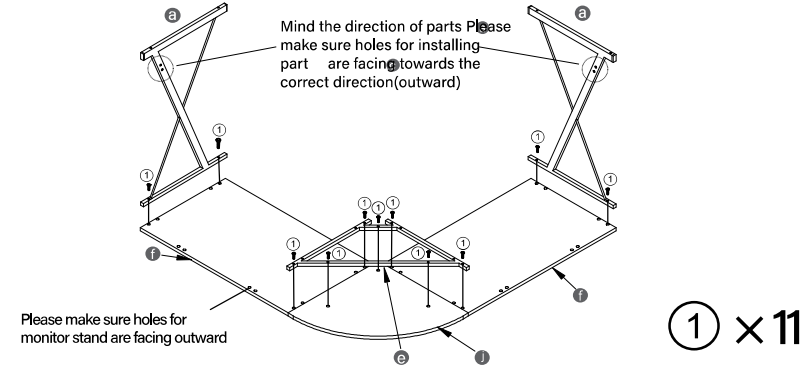

2. Fix frame **b** on frame **e**

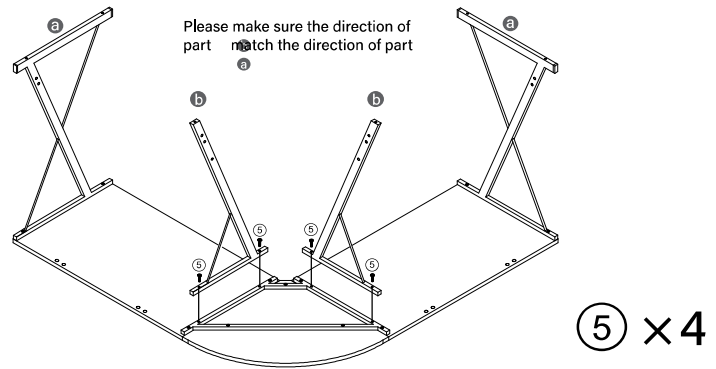

3. Install frame **c** between desk legs

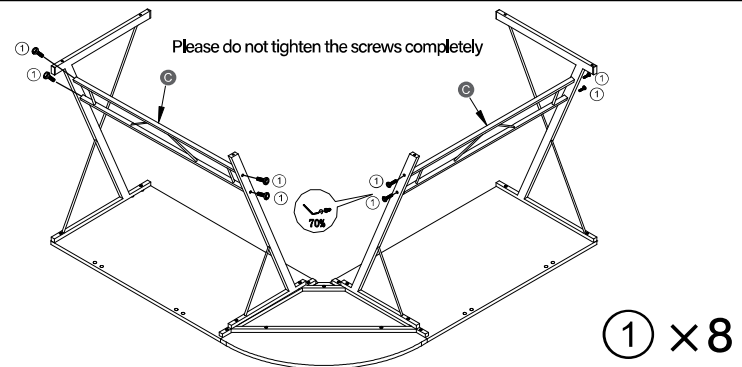

4. Install bar **d** between frame **d**

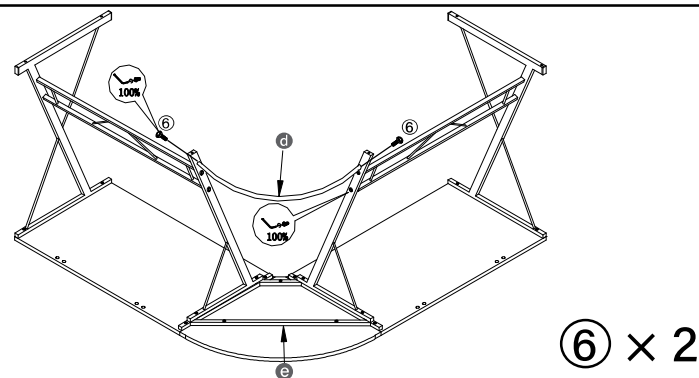

5. Foot pad assembly

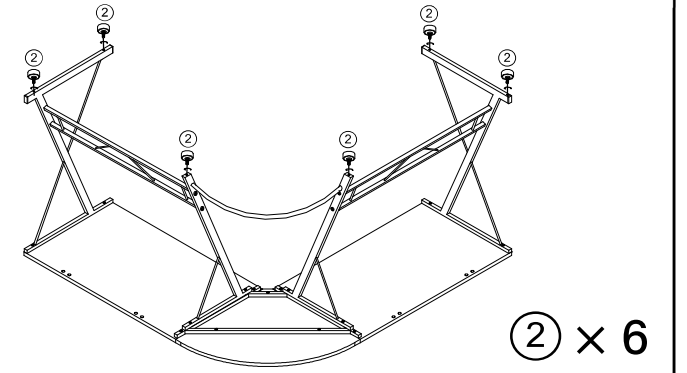

6. Monitor shelf assembly

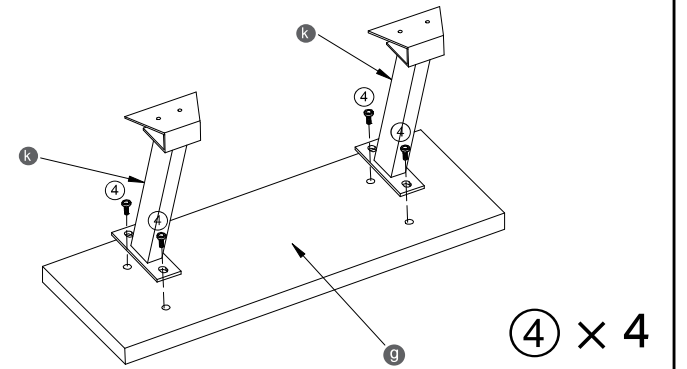

7. Install monitor shelf

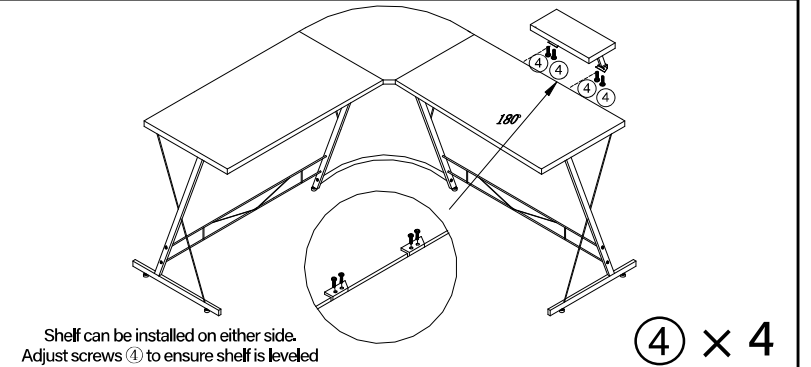

8. Finished!

