

# INSTRUCTION MANUAL

## Outdoor Rocking Chair

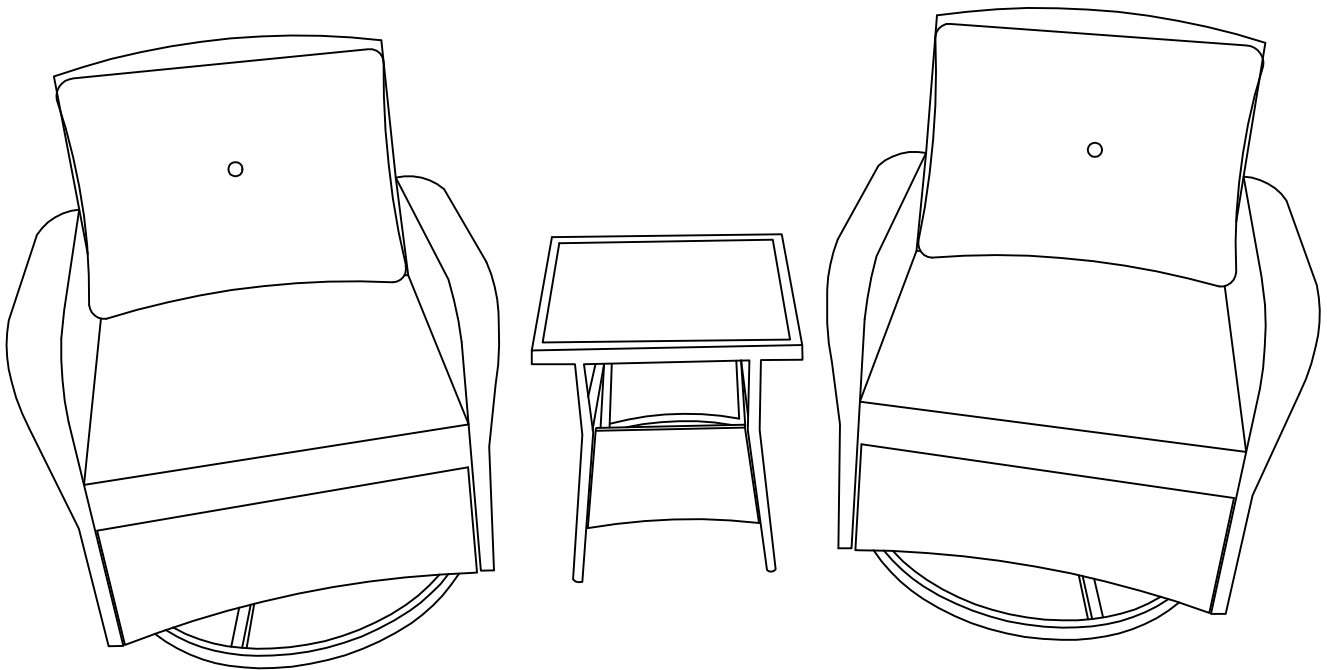

















LYOT168

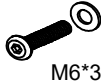

### **ATTENTION:**

- A. Please check the manual carefully and make sure you have received all the parts.
- B. If there is any missing, please let us know the letter of the parts you need.
- C. If there is any damage, please send clear photos to us, we will check and offer you the best solution soon.

# Packing List of Box

Label No.	Img	Part Name	Qty
A		TABLE TOP	1
B		TABLE FOOT	2
C		TABLE SIDE	2
D		TABLE GLASS	1
E		LEFT ARMREST	2
F		RIGHT ARMREST	2
G		BACK SEAT	2
H		SEAT BOARD	2
L		ROCKER ARM BRACKET	2
M		BASE	2
N		BACK CUSHION	2
O		SEAT CUSHION	2
a1	 M6*15	SCREW M6*15	4
a2	 M6*30	SCREW M6*30	16
a3	 Spanner(W) x 1	SPANNER(W)	1
a4	 M6*35	SCREW M6*35	8
a5	 M6*40	SCREW M6*40	20
a6	 M6*5	WASHER	8
a7	 Wrench(V) x 1	WRENCH(V)	1
a8	 M6	NUT M6	8

STEP 1

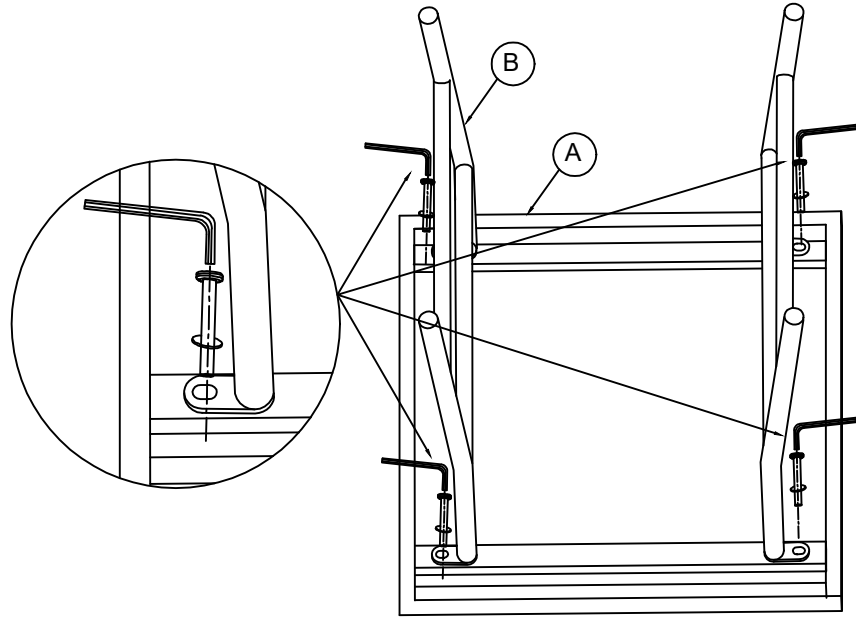

4pcs	1pc	1pc	2pcs
a1	a3	A	B
M6*15	Spanner(W) x 1		

STEP 2

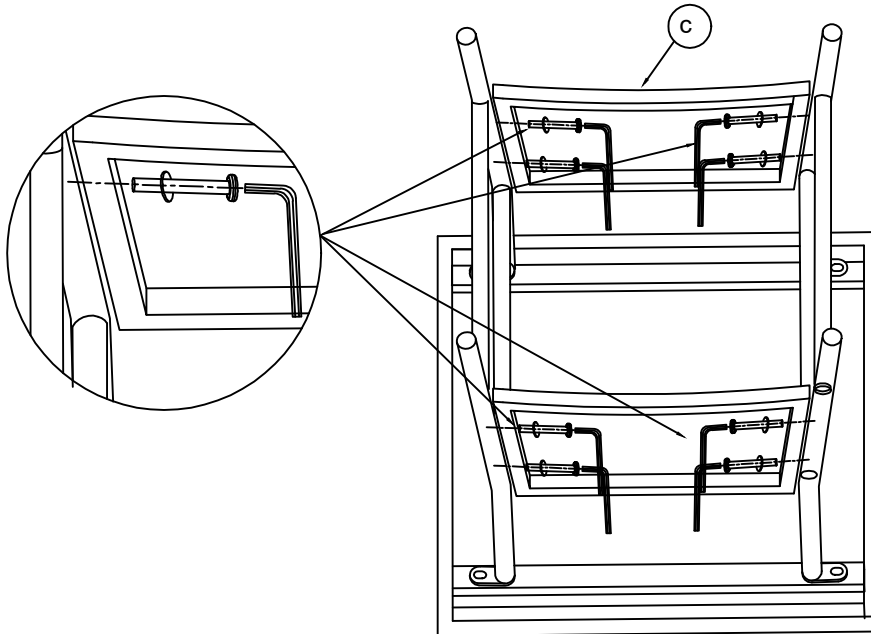



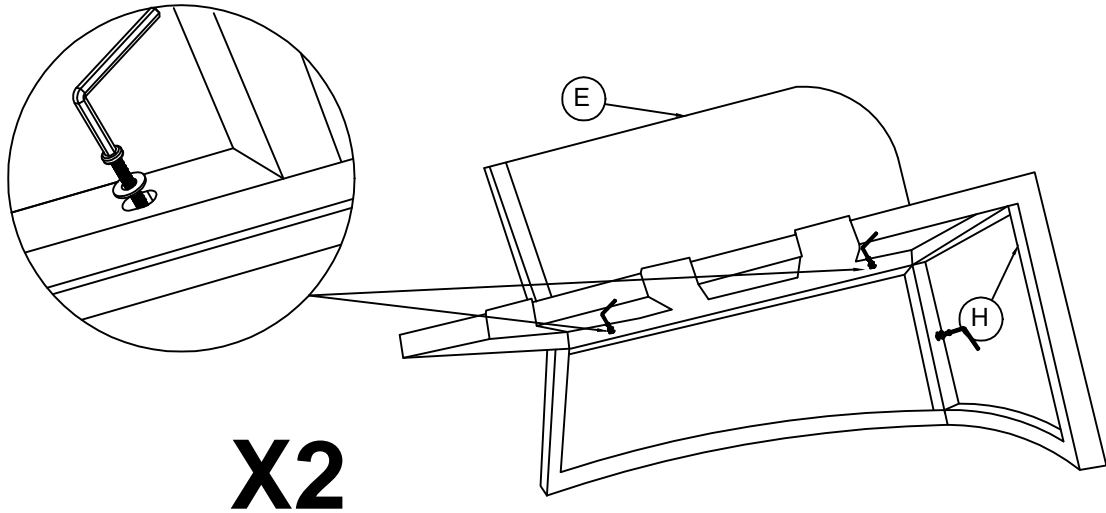

8pcs	1pc	2pcs
a2	a3	C
M6*30	Spanner(W) x 1	

Do not fully tighten all screws until assembly is completed.



STEP 1

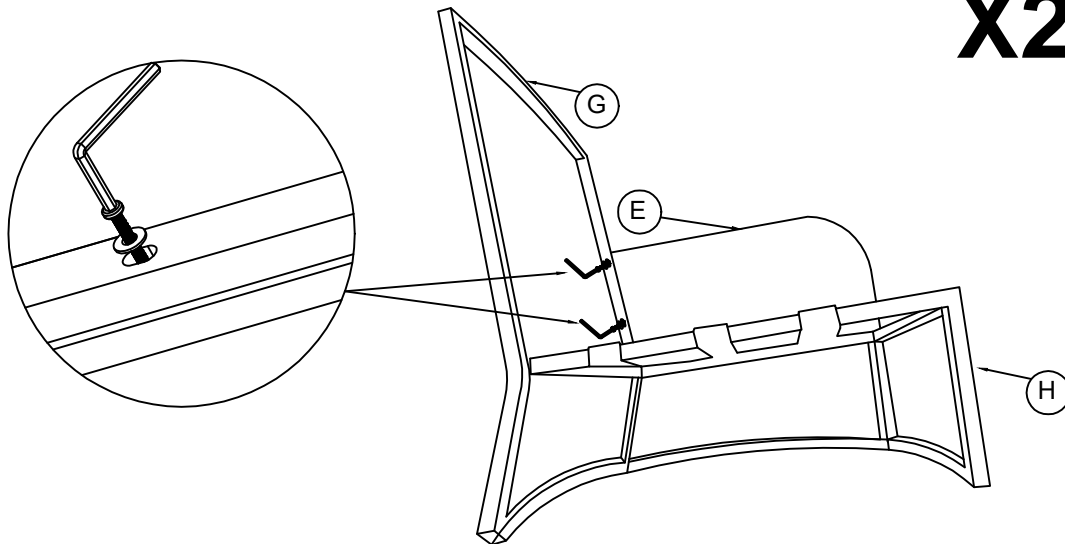

3pcs*2	1pc	1pc*2	1pc*2
 a5	 a3	 E	 H
M6*40	Spanner(W) x 1		

STEP 2





2pcs*2	1pc	1pc*2
 a5	 a3	 G
M6*40	Spanner(W) x 1	

Do not fully tighten all screws until assembly is completed.

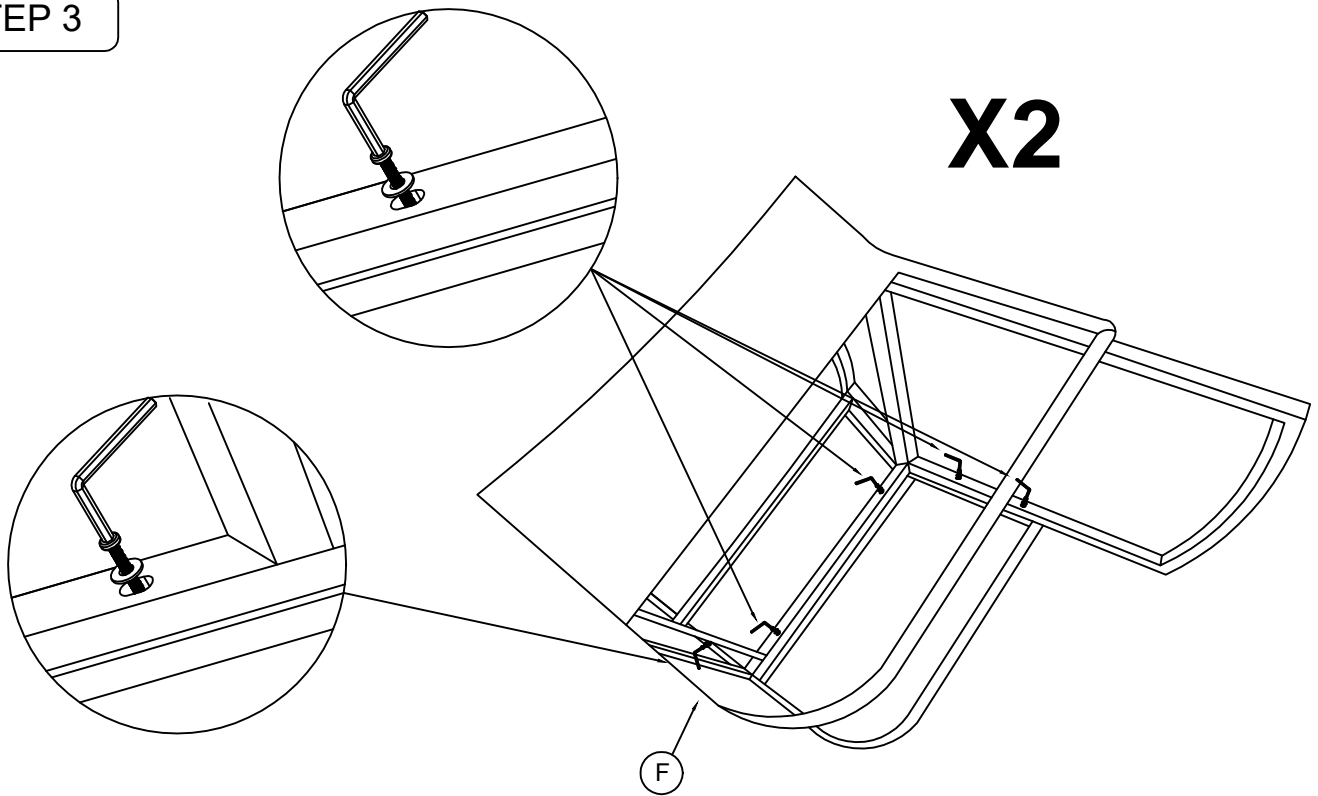



STEP 3

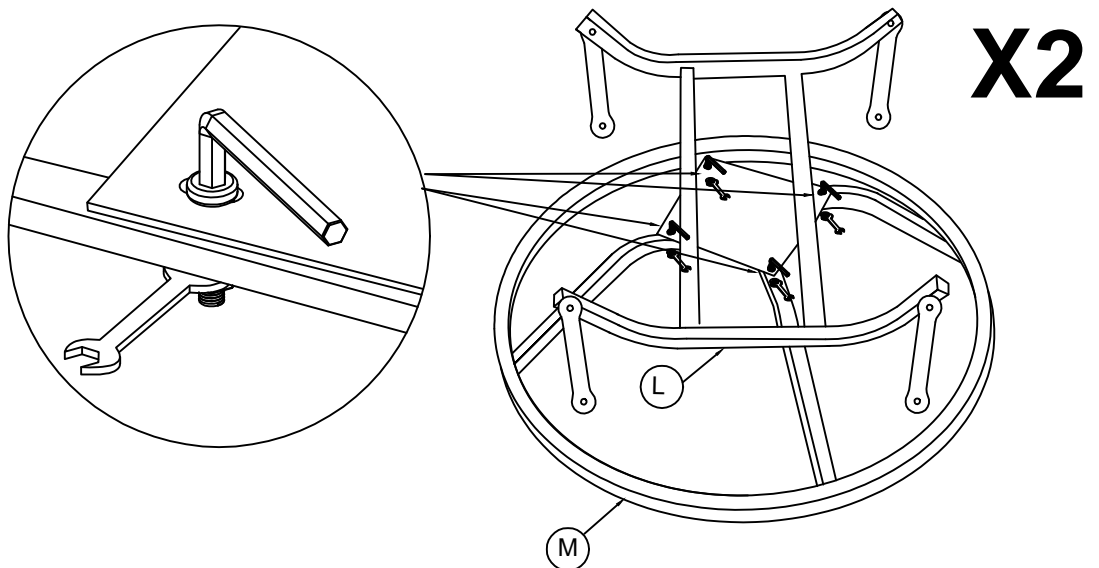

5pcs*2  M6*40	1pc  Spanner(W) x 1	1pc*2  F
a5	a3	

STEP 4

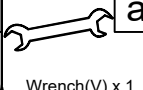

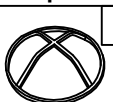



4pcs*2  M6*30	1pc  Spanner(W) x 1	4pcs*2  M6	1pc  Wrench(V) x 1	1pc*2  L	1pc*2  M
a2	a3	a8	a7		

Do not fully tighten all screws until assembly is completed.

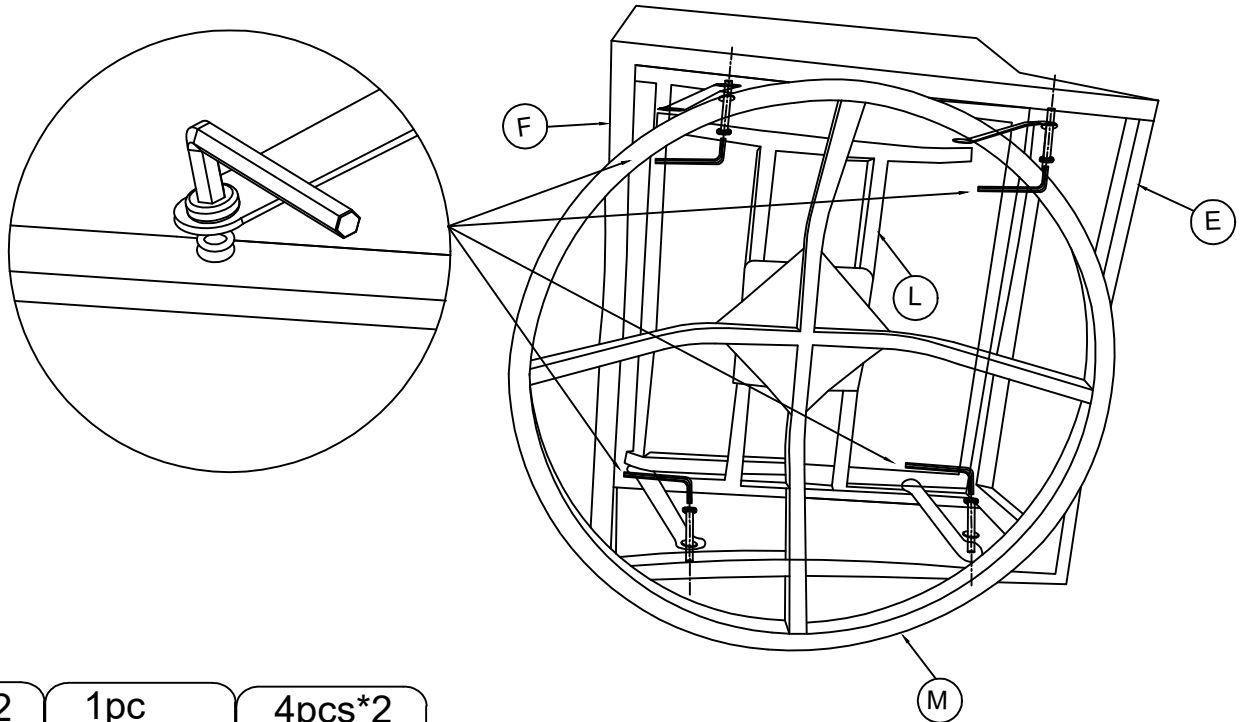
STEP 5



X2

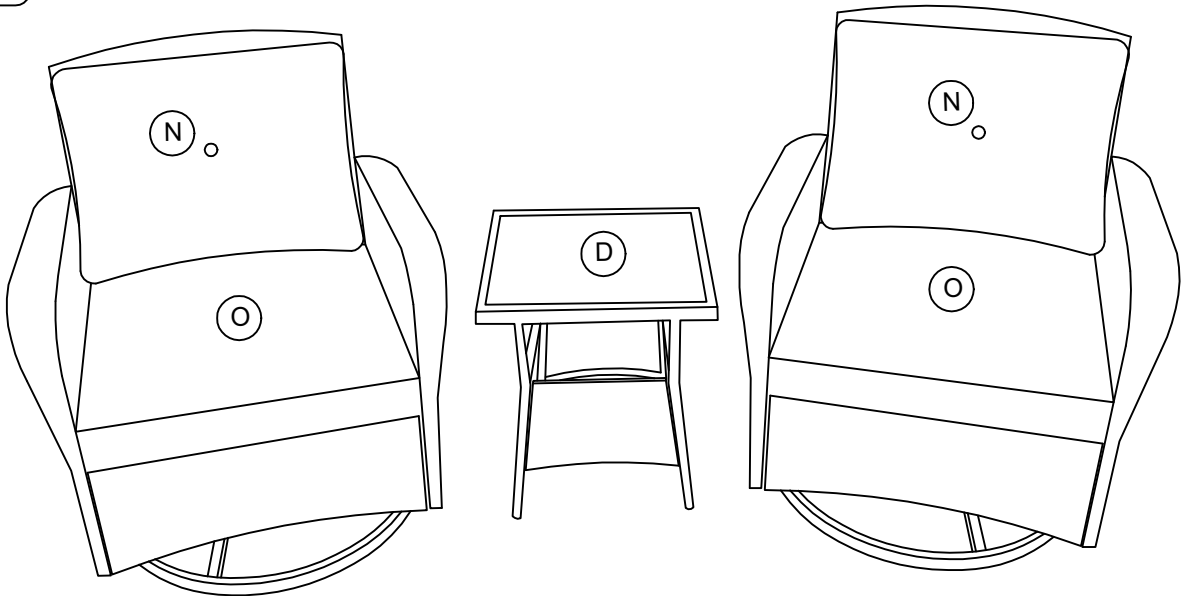

4pcs*2  M6*35	1pc  Spanner(W) x 1	4pcs*2 
a4	a3	a6

STEP 6



2pcs  N	2pcs  O	1pc  D
---	--	---

Do not fully tighten all screws until assembly is completed.