



IMPORTANT INFORMATION

READ CAREFULLY.

KEEP THIS INFORMATION FOR FURTHER REFERENCE.

GENERAL GUIDELINES

- Please read the following instruction carefully and use the product accordingly.
- Please keep this manual and hand it over when you transfer the product.
- This summary may not include every detail of all variations and considered steps. Please **contact us** when further information and help are needed.

NOTES

- Please follow the assembly instructions precisely and only use the product as intended.
- If an odor is present when first opening the package, please leave the unwrapped product in a shaded and ventilated area for a few days to air out.
- Prior to assembly, please check the product for defects or missing accessories. If any defects are found or accessories are missing, do not use product as damage or injury may occur; Please **contact us** for assistance and replacement.
- During assembly, please only slightly tighten all screws in their correct position first, then fully tighten them. A Phillips screwdriver is recommended but not included.
- It is suggested you regularly check the products bolts and connections to ensure safe use.
- Assemble the item on a soft flat and clean surface to avoid scratches and damage.
- It is recommended that two people assemble this product.

WARNINGS

- During assembly, keep parts and packaging materials away from children and pets as there could cause injury and are a potential choking hazard.
- Avoid sharp objects or corrosive chemicals to prevent damage to the product.
- Please open the item slowly and cautiously to avoid pinching your hands by metal joints, especially children.

ANTI-TIP WARNING

- Serious or fatal crushing injuries can occur from furniture tip-over. To prevent this furniture from tipping over it must be permanently fixed to the wall.
- Since different wall materials require different types of fixing device, for advice on suitable fixing systems, contact your local specialized dealer.

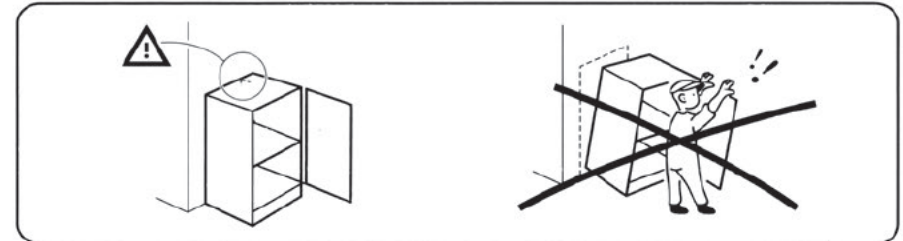
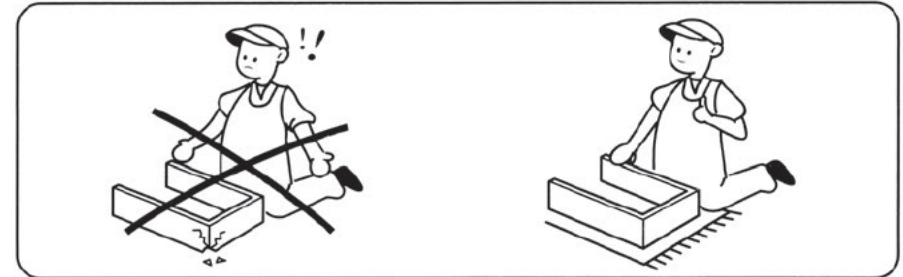
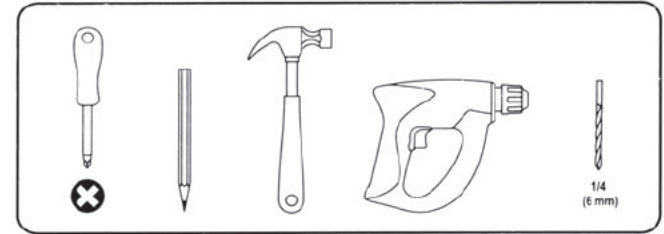





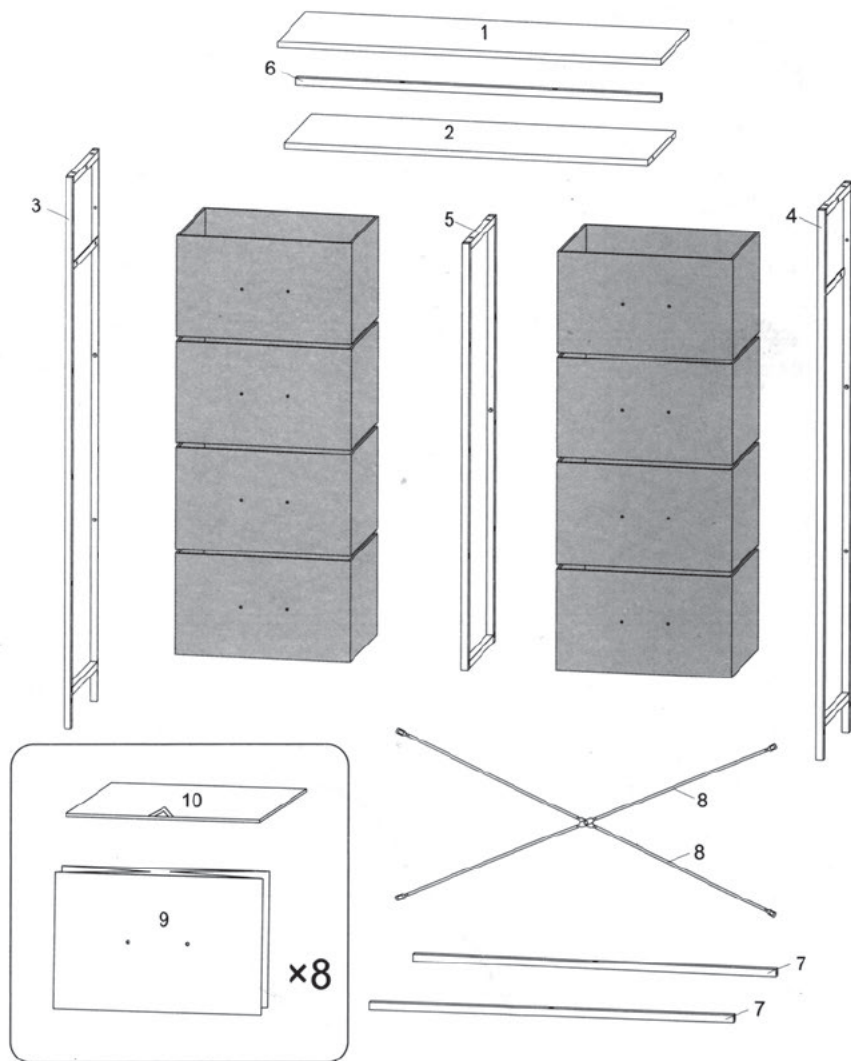







- If you have any further questions, please feel free to contact us by email. We will reply ASAP.
- Before installation, please make sure you have all the hardware, the serial numbers are properly labeled corresponding to the list, and the quantity is correct.
- Enjoy your new purchase!

EXPLODED DRAWING





PARTS

 A X4 M5x30	 B X21 M6x23	 C X16 M4x12	 D X8
 E X5	 F X4	 G X1	 H X1
 I X2	 J X2	 L X8 Left	 R X8 Right

1

REMARK

Put a blanket under the board to avoid scratch or damage.

 B X2 M6x23
 H X1

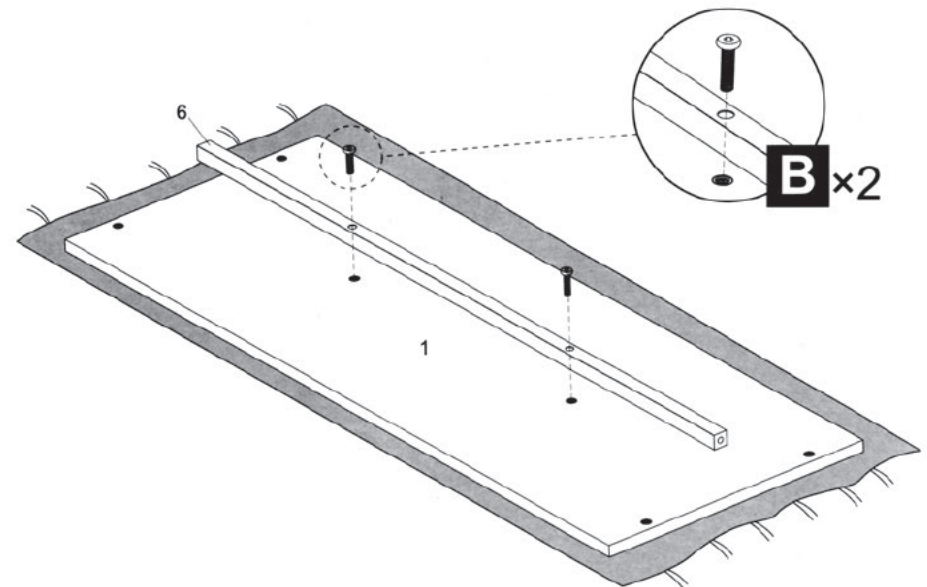

2

REMARK

1. Please note that the holes indicated by fingers on the steel frame should face the same direction.
2. Please do not fully tighten screws until all screws are in place.

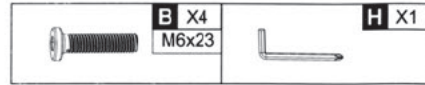

3

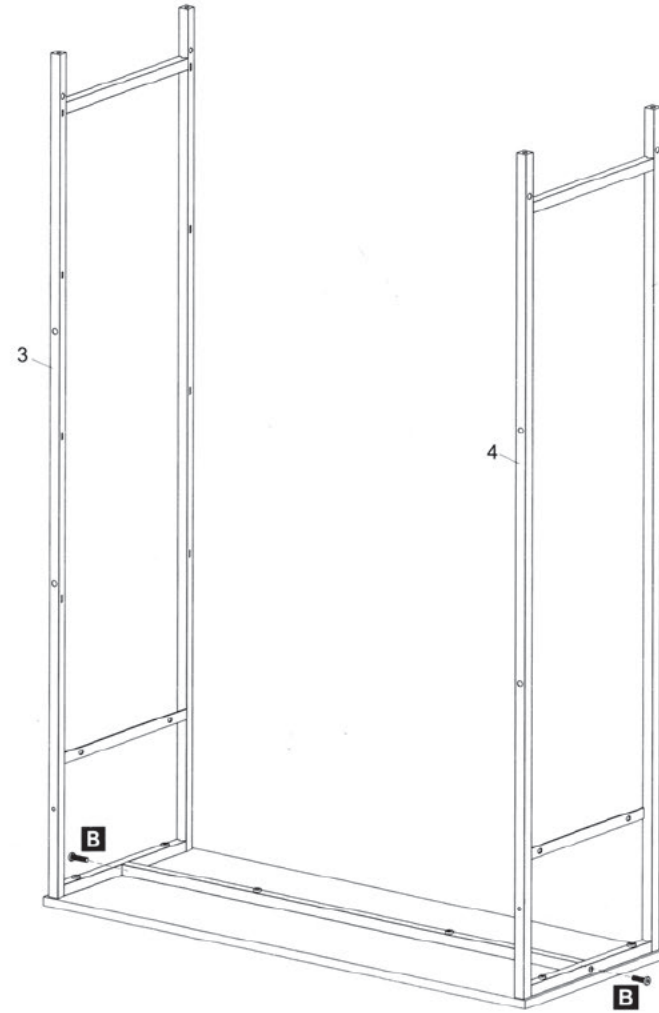
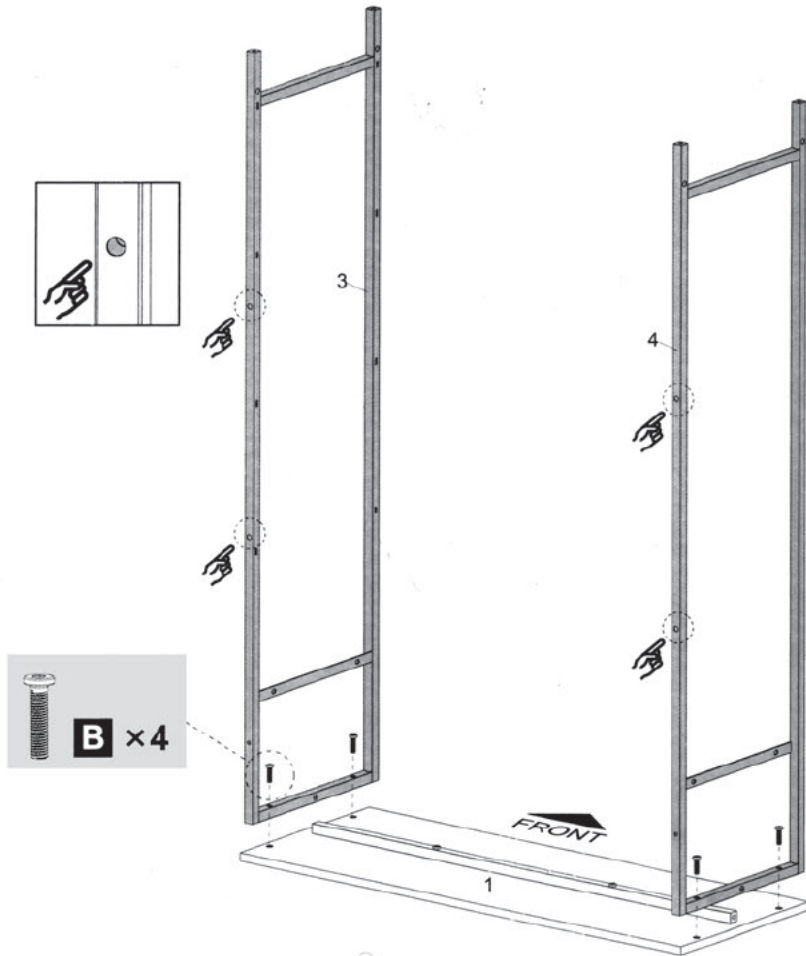
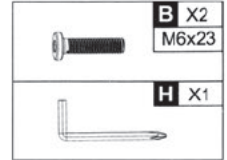

4

REMARK

Please do not fully tighten screws until all screws are in place.

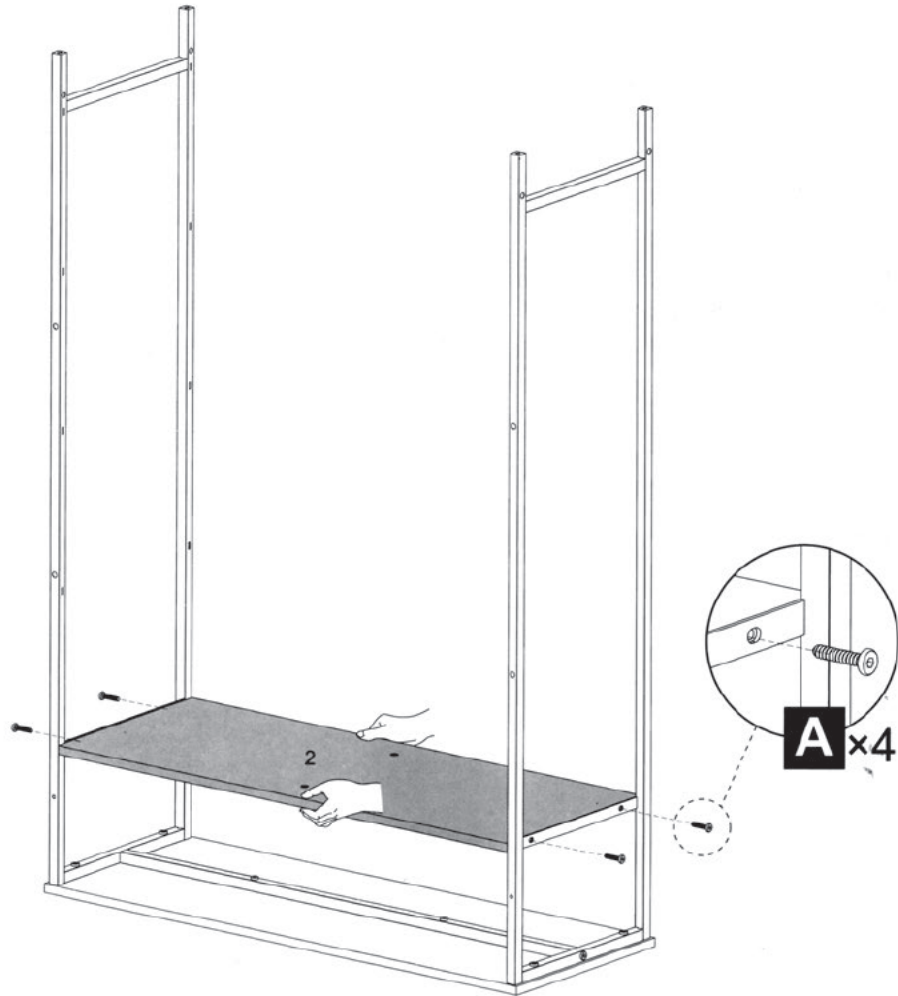
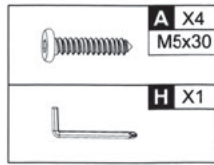

5

REMARK

Please note that the holes indicated by fingers on the steel frame should face the same direction.

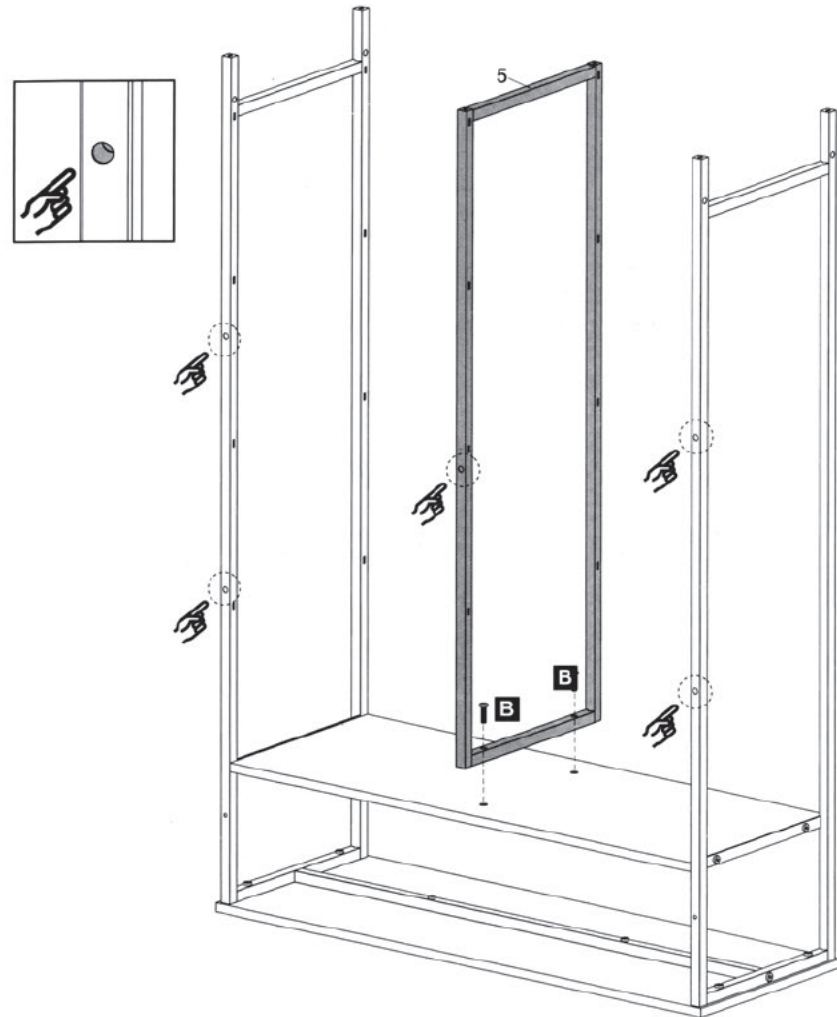
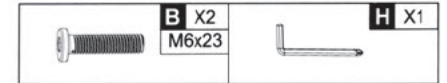

6

REMARK

Please do not fully tighten screws until all screws are in place.

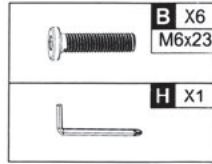

7

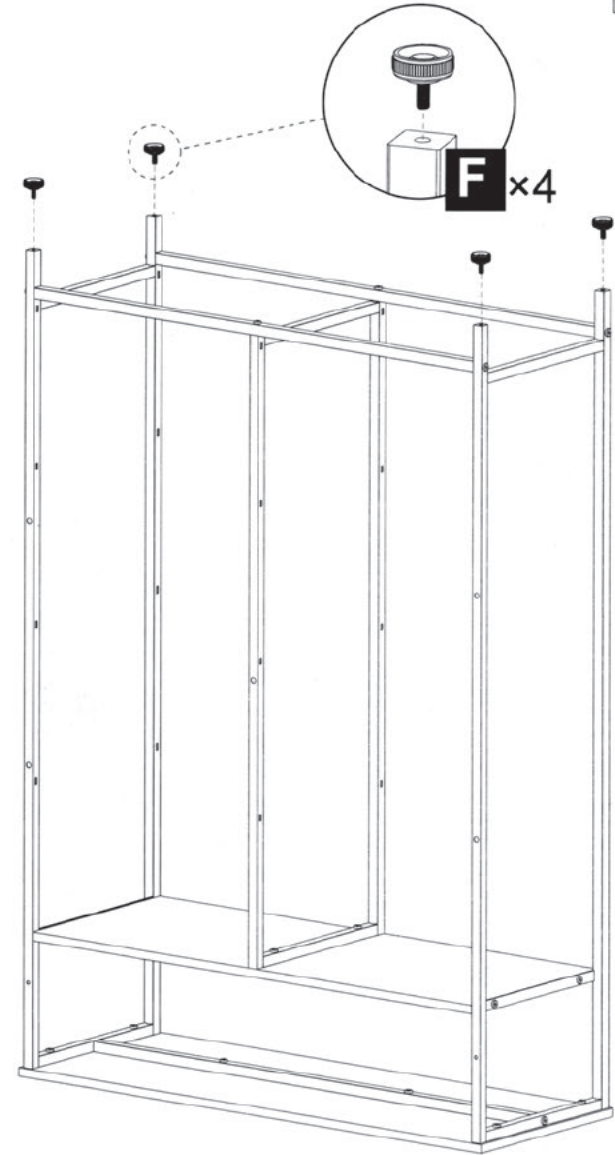

8

REMARK

Please do not fully tighten screws until all screws are in place.

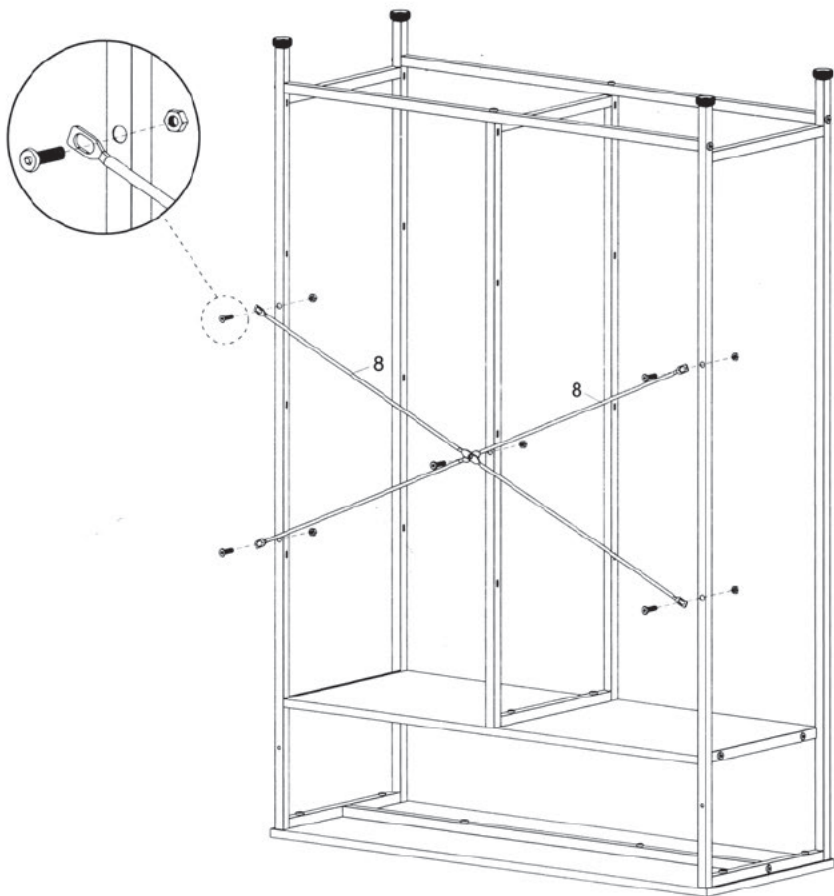
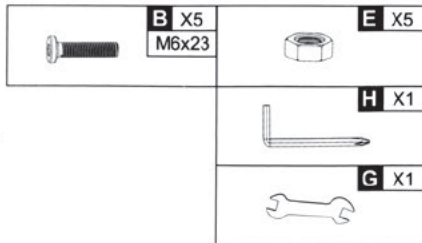

9

REMARK

The guide rail is engraved with L(Left) and R(Right). Please install cautiously according to the instructions.

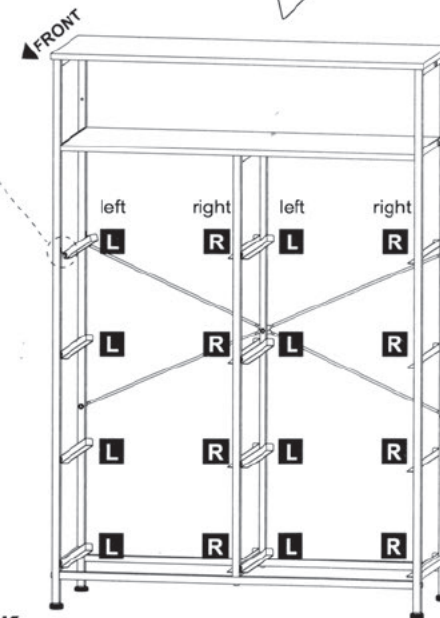
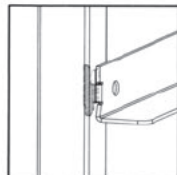
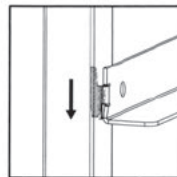
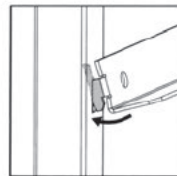
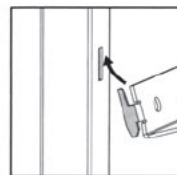
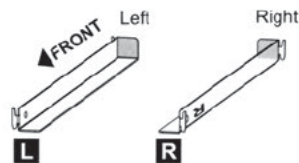
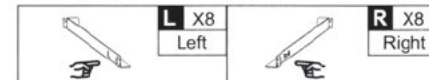

REMARK

The front and back buckles should be fastened at the same time. In case the buckles is bent due to faulty installation, we prepare spare guide rails for you.

10



11

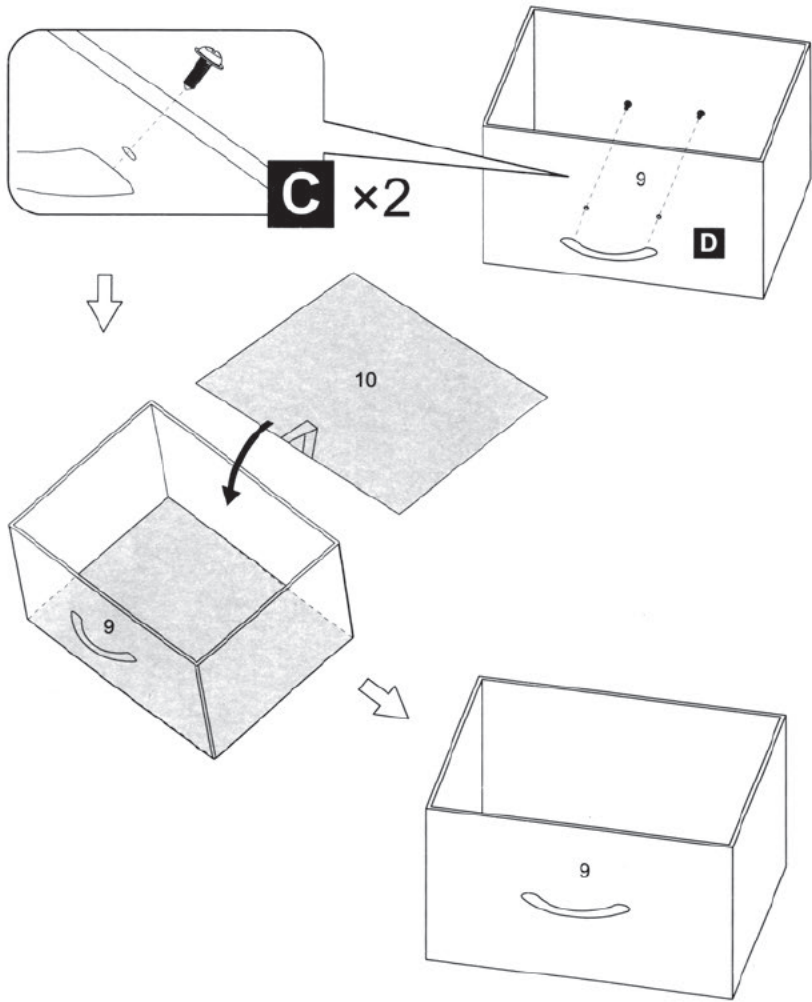

×8

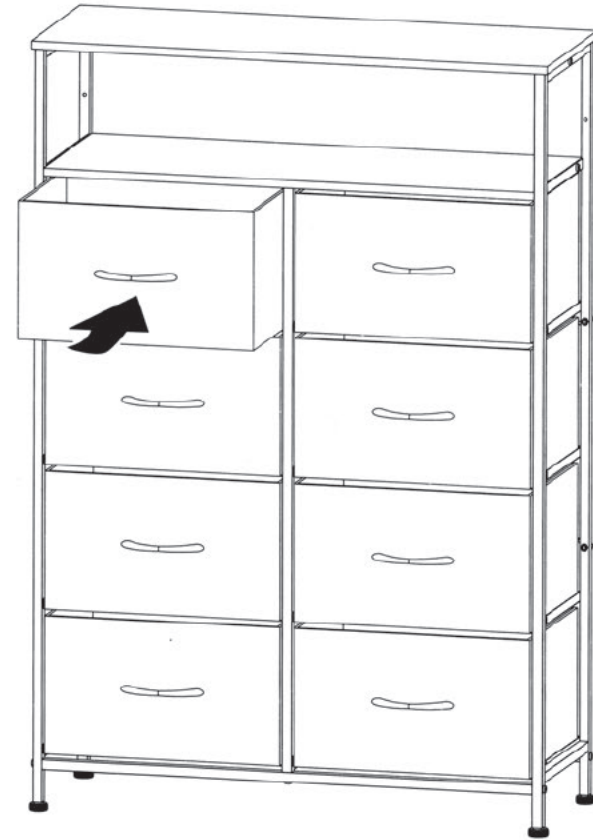

Please install anti-tip device as following steps if you need

Step 1

REMARK

Please choose the proper position before assembling.

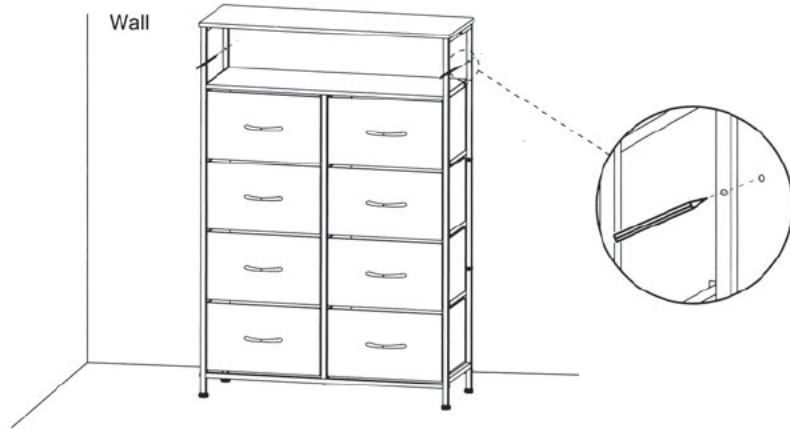

Step 2

Wall



Step 3

J X2

Wall

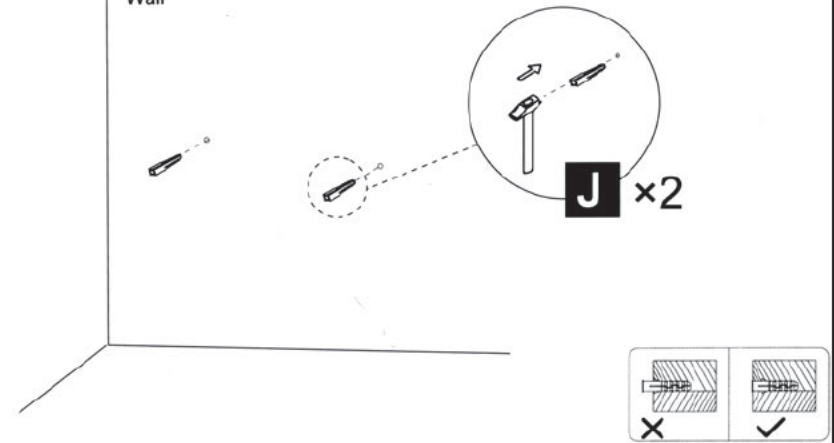

Step 4

I X2

Wall

