

# SOFA INSTALLATION INSTRUCTIONS

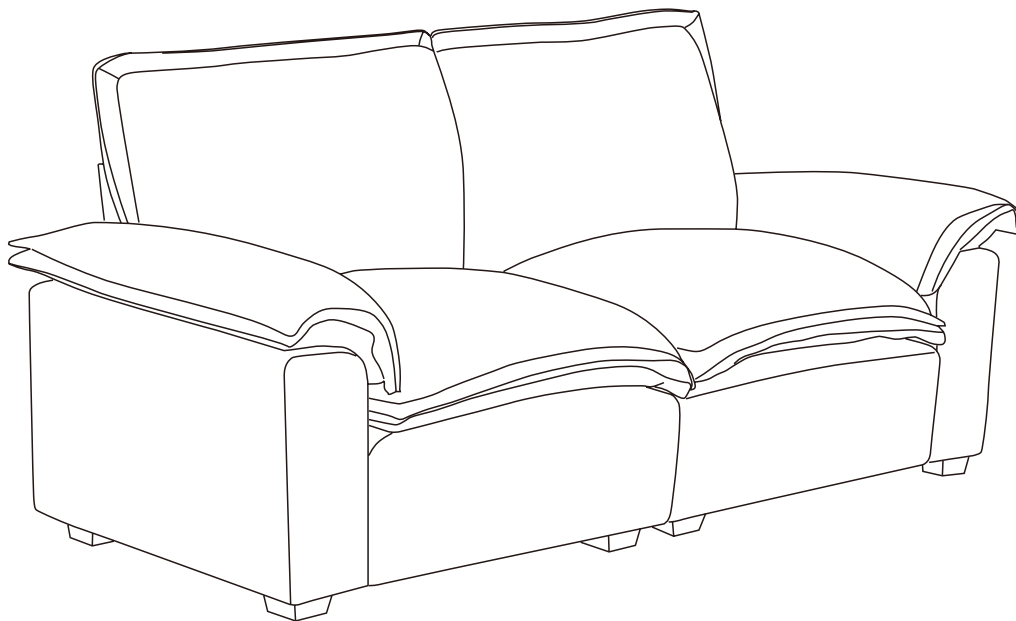

Thank you for choosing our products.  
To ensure a smooth installation, please read these  
instructions carefully and follow the steps provided  
below.

# **IMPORTANT:RETAIN FOR FUTURE REFERENCE. READ CAREFULLY.**

## **Instructions for use:**

- \*Place the sofa securely on a flat surface.
- \*Keep away from open flames.
- \*Do not overload the sofa.

## **Precautions before assembly:**

- \*Prepare a clean and dry area for assembly.
- \*Ensure the product is not damaged.
- \*Verify that all parts are included.

## **Maintenance:**

- \*Clean with a soft cloth.
- \*Regularly check the stability of the seating.

## **Storage conditions:**

- \*Store the fabric completely dry in a clean, dry place to prevent mold growth.

**A x1**

left

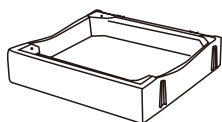

**B x1**

right

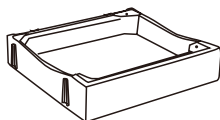

**D x2**

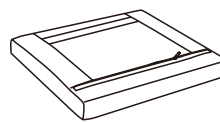

**F x2**

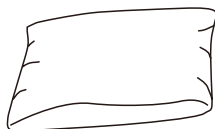

**G x2**

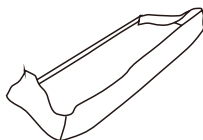

**I x2**



**J x8**

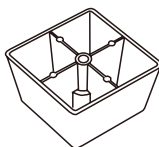

**K x8**

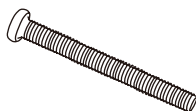

**L x2**



**C x2**

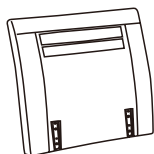

**E x2**



**H x2**

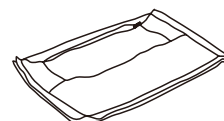

**M x1**

left

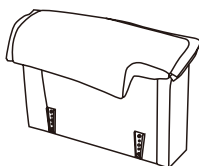

**N x1**

right

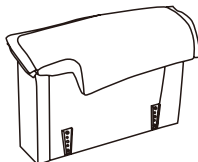

01

(J) \*2 (K) \*2 (L) \*1

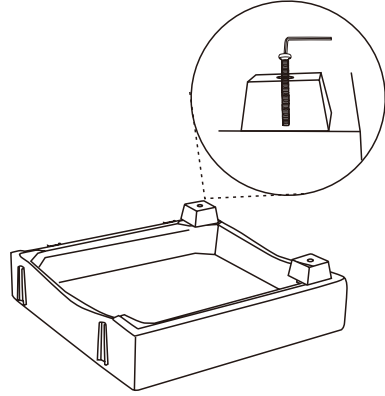
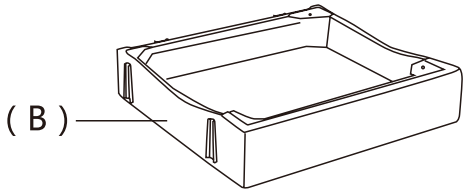
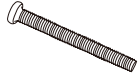
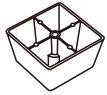

02

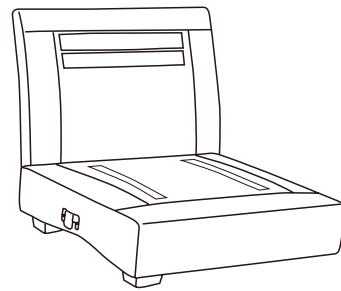
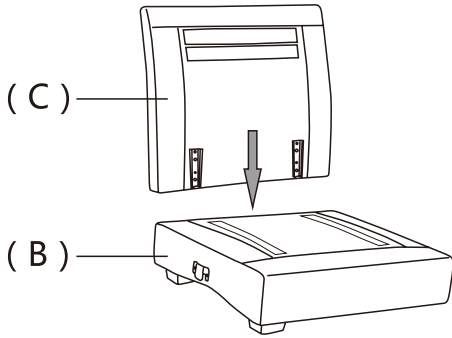

03

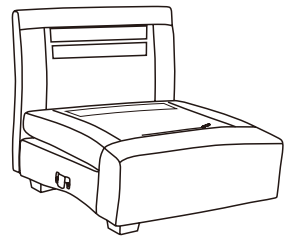
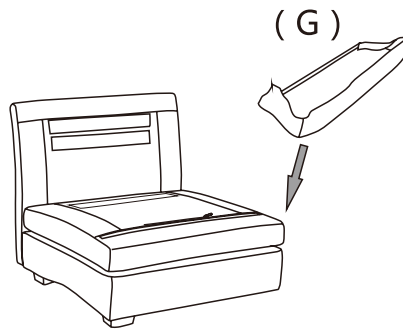
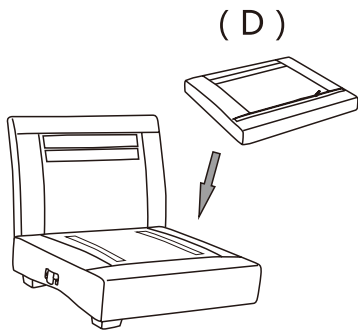

04

(J) \*2 (K) \*2 (L) \*1

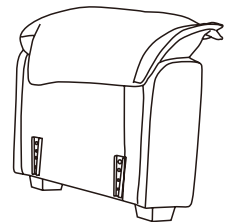
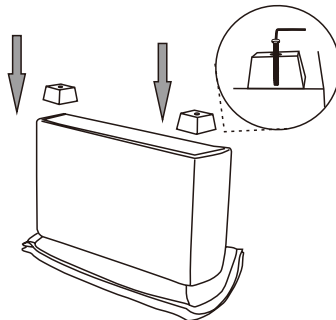
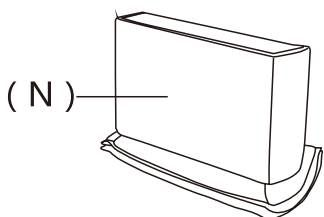

05

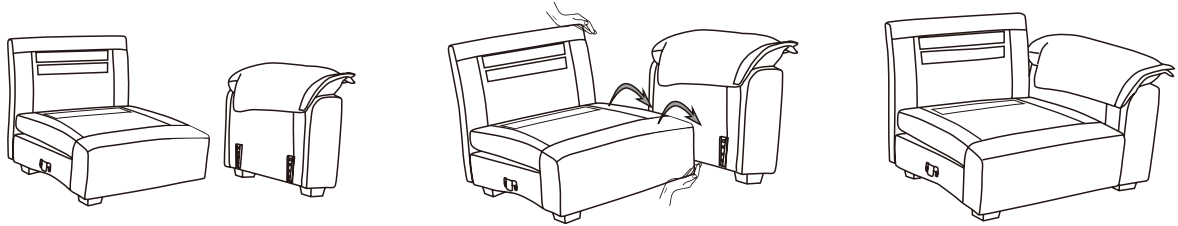

\* Insert the seat frame insert into the armrest insert, from top to bottom.

06

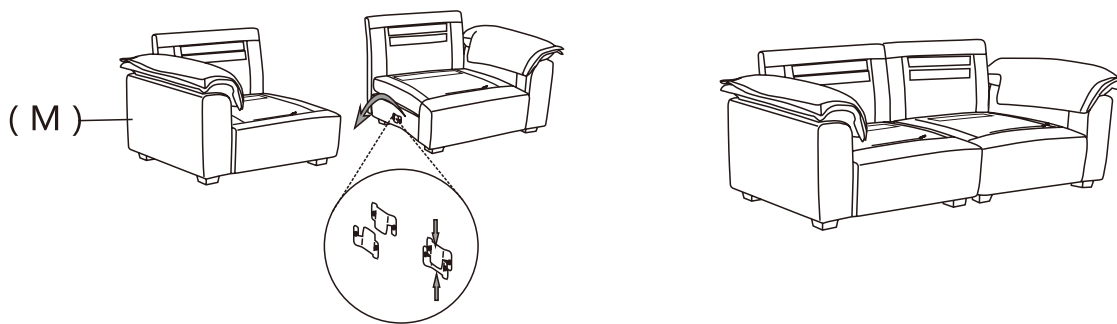

07



\* After unpacking, it takes some time ( 48 hours ) for the soft package to rebound.  
Tap the soft bag with your hand to accelerate the rebound effect.

08

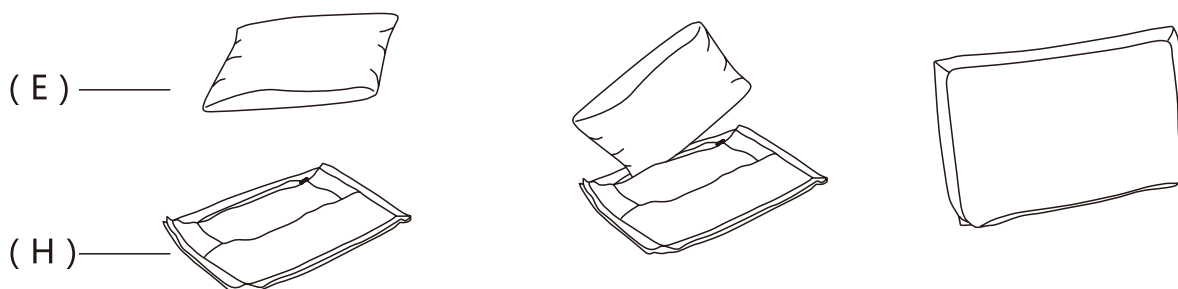

\*Insert the pointed side of the soft bag inward into the cloth cover.

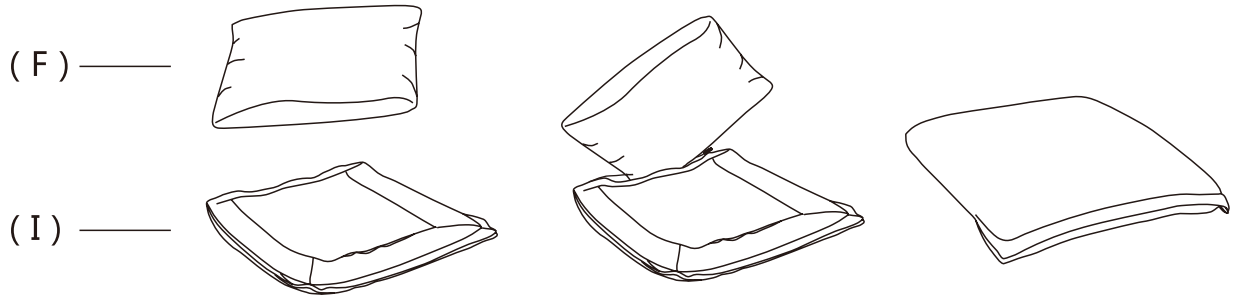

\*Insert the pointed side of the soft bag inward into the cloth cover.

