

SEU244ETB

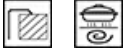

Product family	Cooktop
Installation	Ultra-low profile
Dimensions	24"
Power supply	Electric
Type	Ceramic
EAN code	8017709240998

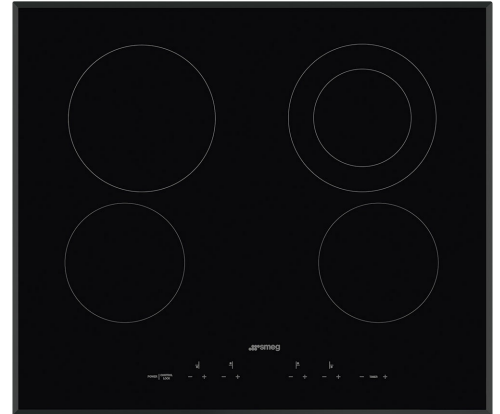

Aesthetic



Aesthetics	Universal
Color	Black
Finishing	Glass
Material	Glass
Glass	Ceramic
Glass edge	Beveled
Control setting type	Touch controls
Controls position	Front
Silkscreen color	Gray

Programs / Functions



Cooking zones	4
Cooking zones with Booster	4
Power levels	9

Options



End cooking timer	1	Limited Power	4000 W
End-of-cooking acoustic alarm	Yes	Consumption Mode in W	
		Showroom mode	Yes
		Child safety lock	Yes

Limited power consumption option Yes

Technical Features



Front-left - Ceramic - single - 1.20 kW - Ø 14.8 cm

Rear-left - Ceramic - single - 1.80 kW - Ø 18.4 cm

Rear-right - Ceramic - double - 0.75 - 1.80 kW - Ø 12.4 - Ø 18.4 cm

Front-right - Ceramic - single - 1.20 kW - Ø 14.8 cm

Automatic switch-off in case of over-heating Yes

Residual heat indicator Yes

Automatic switch-off in case of overflow Yes

Electrical Connection

Nominal power	6000 W	Electric cable type	Single phase
Current	18 A	Frequency	60 Hz
Voltage	240 V	Power cord length	47 1/4 "
Voltage 2 (V)	208 V	Terminal box	6 poles

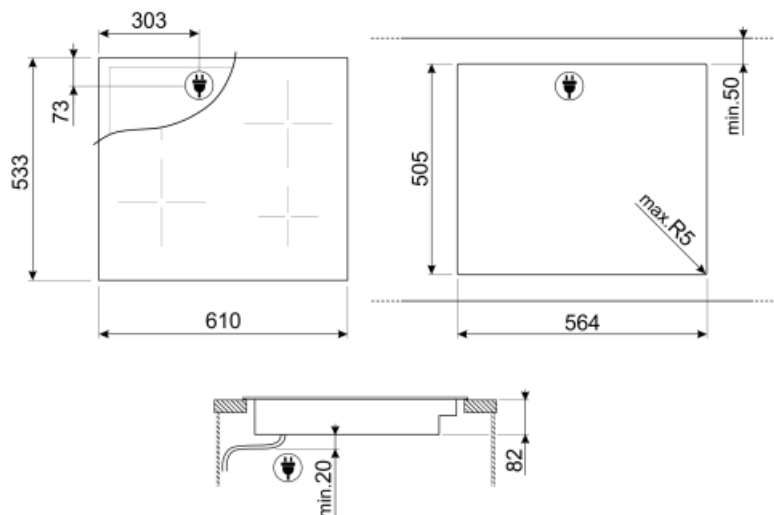











Not included accessories



SCRP

Induction and ceramic hobs and teppanyaki scraper

Symbols glossary (TT)

	Power booster: option allows the zone to work at full power when very intense cooking is necessary.		Ultra-low profile: Installation of product with flat edge - height of 1 mm.
	Child lock: some models are fitted with a device to lock the programme/cycle so it cannot be accidentally changed.		Touch control
	ECO-logic: option allows you to restrict the power limit of the appliance real energy saving.		Overheat protection: The safety system that automatically turns off the hob in case of overheating of the control unit.
	Glass ceramic: The base of the hob is made glass ceramic. Heating is performed by the heating elements Hi-Light.		Overfill protection: The special overfill protection shuts down the stove in the presence of overflow of liquids.
	Indication of residual heat: After the glass ceramic hob is switched off the residual heat indicator shows which of the heating zones still remains hot. When the temperature drops below 60 ° C, the indicator goes out.		Timer: All ceramic hobs have a timer which automatically ends cooking after a preset time.