

Product Assembly Instructions

DINING TABLE





Helpers needed to assemble: 2

Estimate time frame to assemble: 20 minutes

Step 1: Align the wood panel(1) on top of frame(3) as picture.

Step 2: Use allen key (B) to affix the bolt(A) into each hole. Once the screws are in place, tighten the screw with the Allen Key until it is firmly attached.

Step 3: Place the glass top(2) on the top of table.

#	Picture	Description	Quantity
1		Wood panel	1
2		Glass top	1
3		Frame	1
A		Bolts(M6x20)	3
B		Allen Key	1

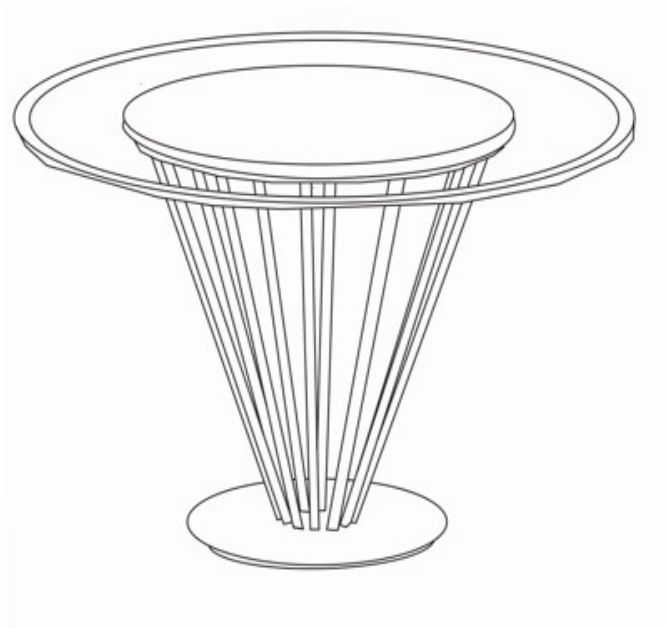
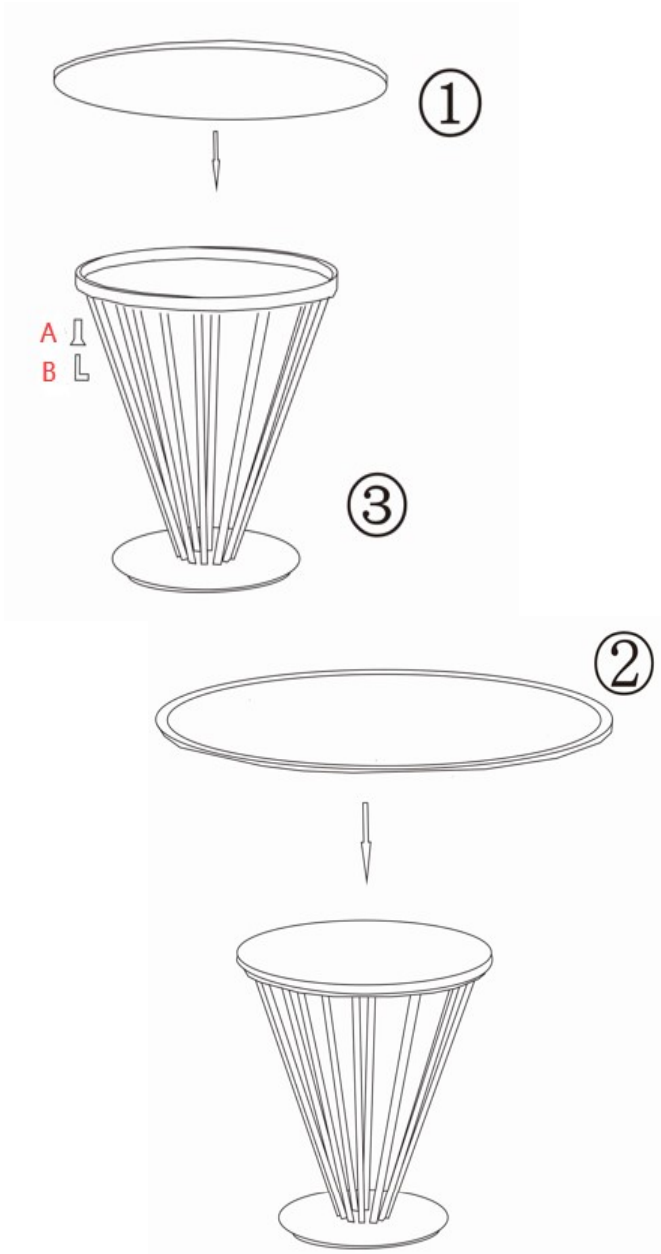

Step 4: Enjoy using your new table.