

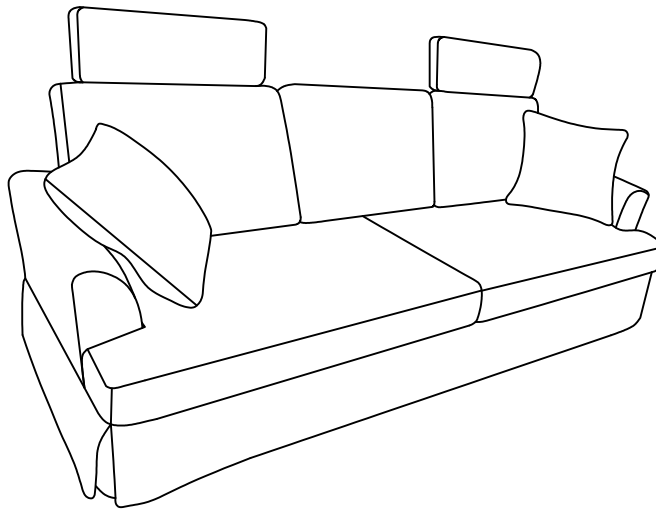

USER MANUAL



Warning Tips:

1. Review the installation instructions and check that all installation parts are complete.
2. Identify the parts (armrests) that need to be differentiated between left and right.
3. Tap the backrest and place it in the sunlight to fluff it up quickly, it takes about 48 hours for the backrest to fluff up.
4. Do not stand or jump on the parts of the sofa to avoid damage.
5. To ensure that the sofa does not get dirty, please make sure that the floor is clean enough before the installation begins.

Before you start...

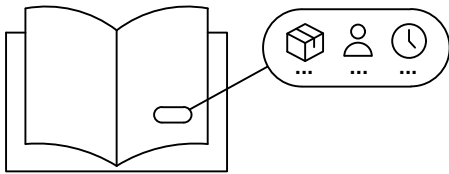

Ensure you have received all cartons and familiarize yourself with the workload. Make sure if you need someone to assist you, and that you have allocated the time required to assemble your new product.

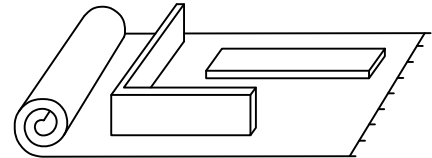

Please ensure that you leave enough space in your home for assembly. We recommend that you place cushions or cardboard on the floor to protect the floor and to ensure that the sofa does not get stained.

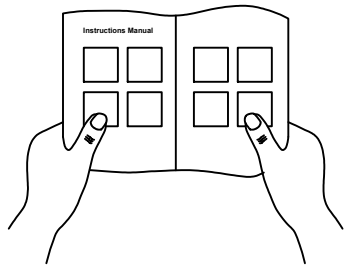

Read instructions carefully and check no parts are missing.

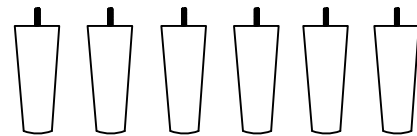

Lay out all hardware on a soft surface so you can easily identify them.

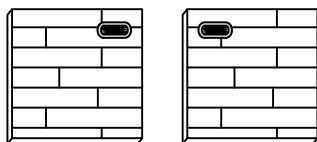

LEFT

RIGHT

Carefully identify all components in order to differentiate which pieces are left and right.

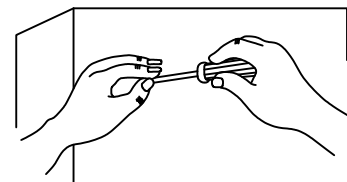

Install your new product carefully following the instructions. Don't skip ahead!

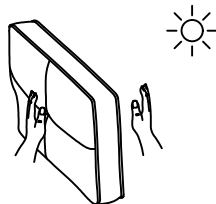

Tap the backrest and place it in the sunlight to fluff it up quickly, it takes about 48 hours for the backrest to fluff up. Pay attention: Because of the compressed packaging, there may be some creases on the cover. Please do not worry, pat it several times and wait for moments, the crease will be more natural and will not affect the use.



Do not stand or jump on the parts of the sofa to avoid damage.

Product Diagram

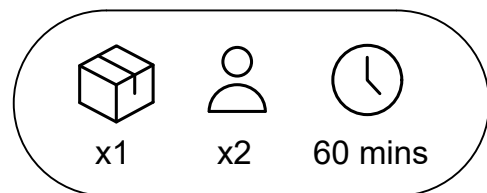

Parts

- A. Pedestal (left)
- B. Pedestal (right)
- C. Backrest (left)
- D. Backrest (right)
- E. Armrest (left)
- F. Armrest (right)
- G. Fabric cover
- H. Cushion (seat)
- I. Cushion (seat)
- J. Cushion (back)
- K. Headrest
- L. Pillows
- M. Sofa legs
- N. Headrest metal frame
- O. Screws
- P. Allen key

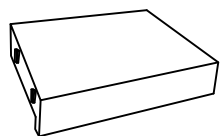
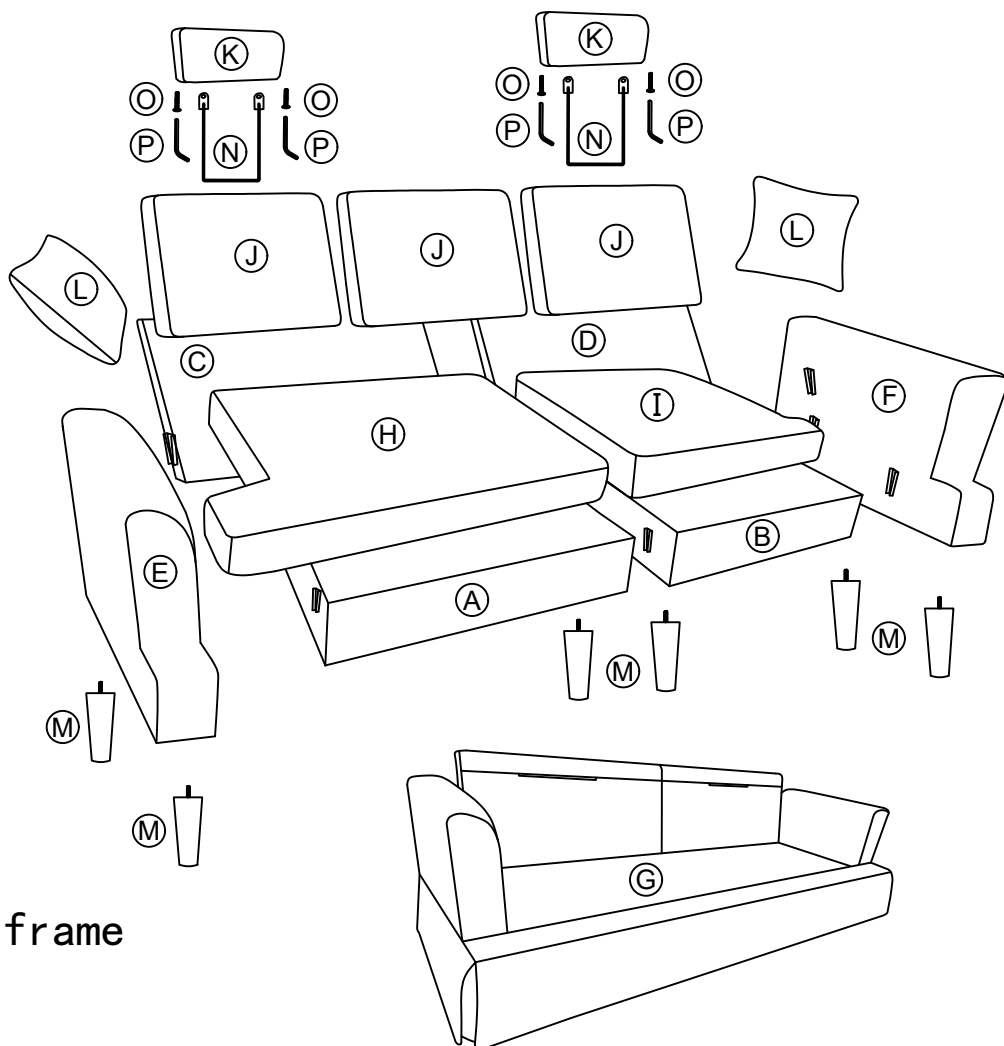

A*1

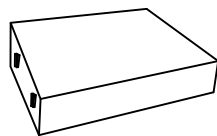

B*1

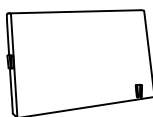

C*1

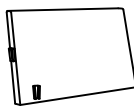

D*1

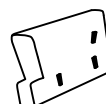

E*1

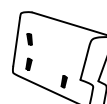

F*1

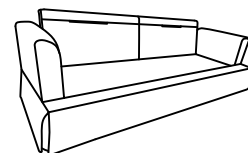

G*1

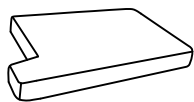

H*1

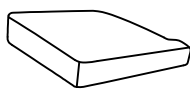

I*1



J*3



K*2



L*2



M*6

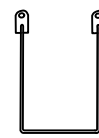

N*2



O*4



P*1

Installation Steps

STEP 1:

The bottom of each armrest (E&F) have sofa components.

Note: Please kindly take out all parts before assembly.

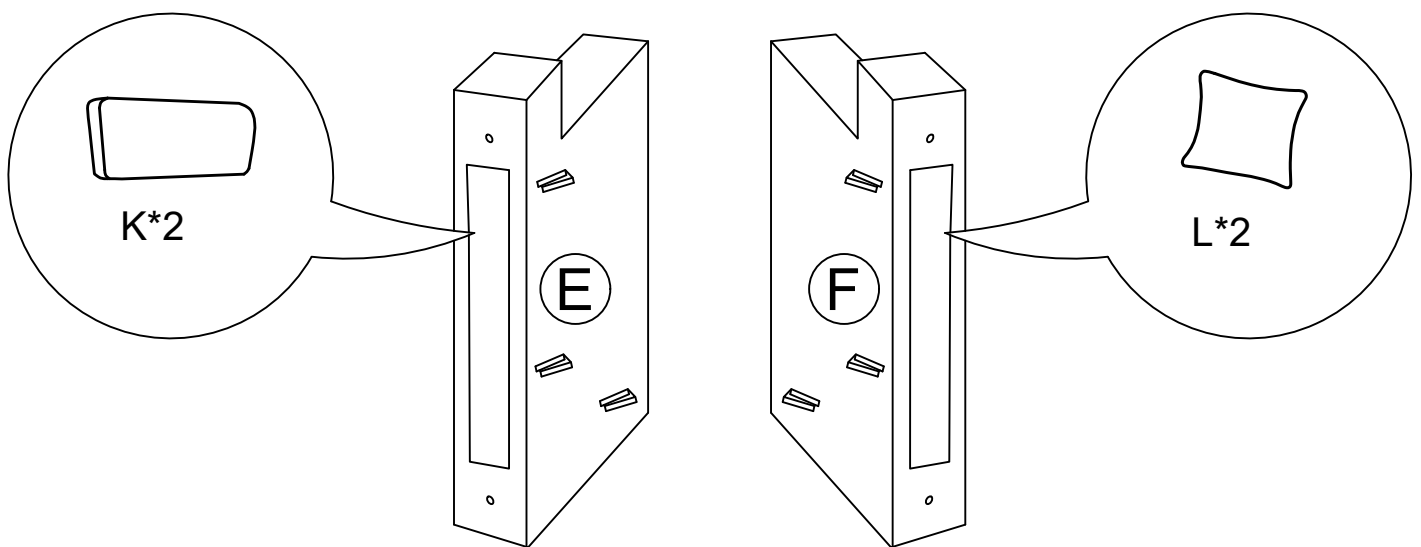

Installation Steps

STEP 2:

a. Install the pedestal (A&B) to the armrests (E&F).

b. Install the pedestal (B) to the pedestal (A).

Note: Place the orbit on the pedestal to the connector on the armrests, and you can slide from top to decline.

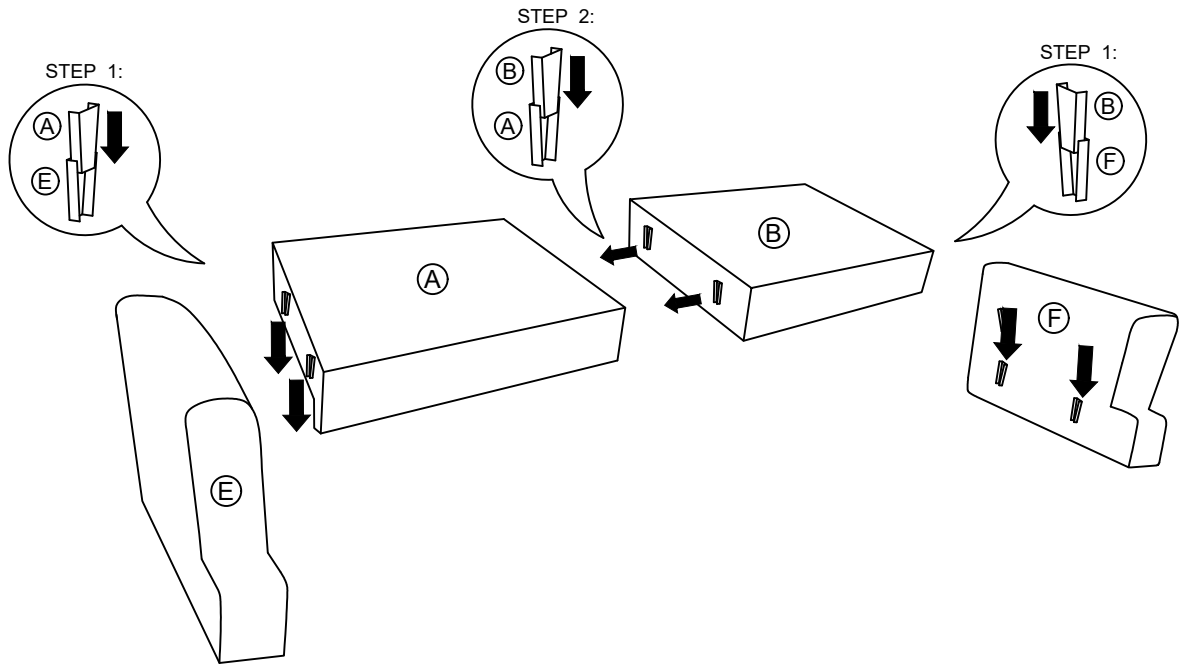

STEP 3:

Install the sofa legs (J) to the armrests and pedestal.

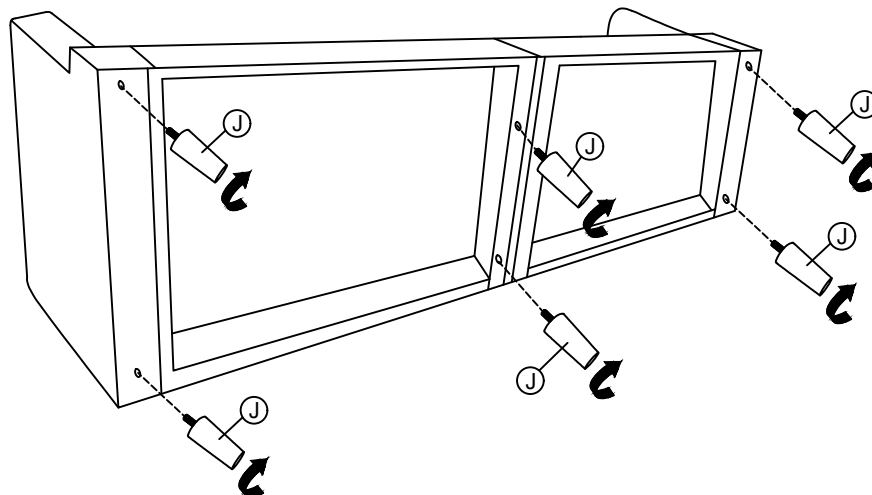

STEP 4:

Install the backrest (C) to the armrest and pedestal.

Note: Place the orbit on the backrest to the connector on the armrest and pedestal, and you can slide from top to decline.

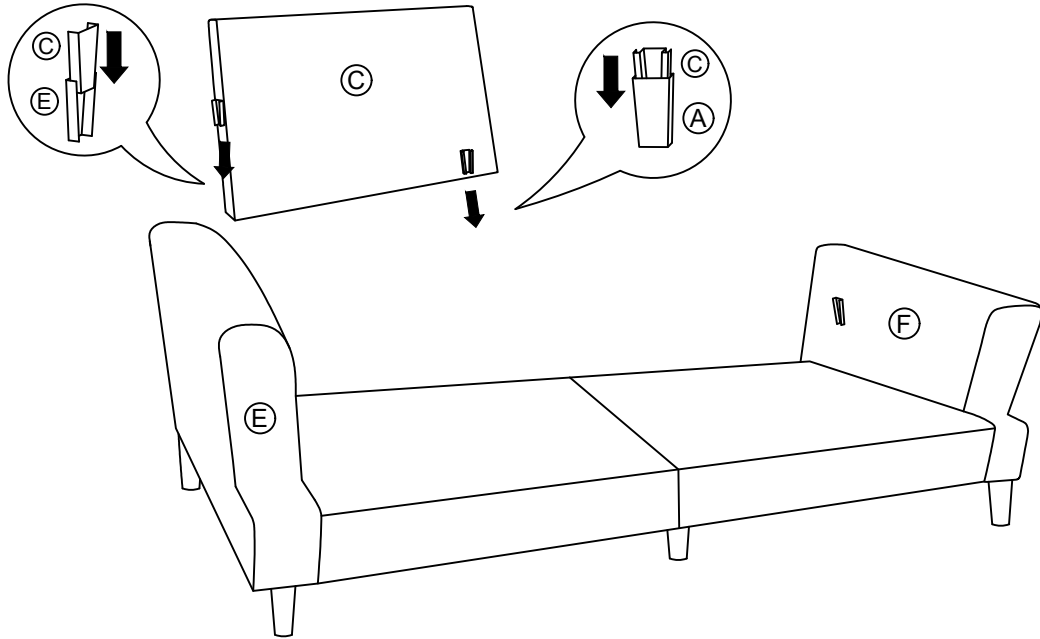

STEP 5:

Install the backrest (D) to the armrest and pedestal.

Note: Place the orbit on the backrest to the connector on the armrest and pedestal, and you can slide from top to decline.



STEP 6:

Put the cushion (G) on the pedestal.

Note: Please kindly remove the cover tape from the velcro before placing the cushion.

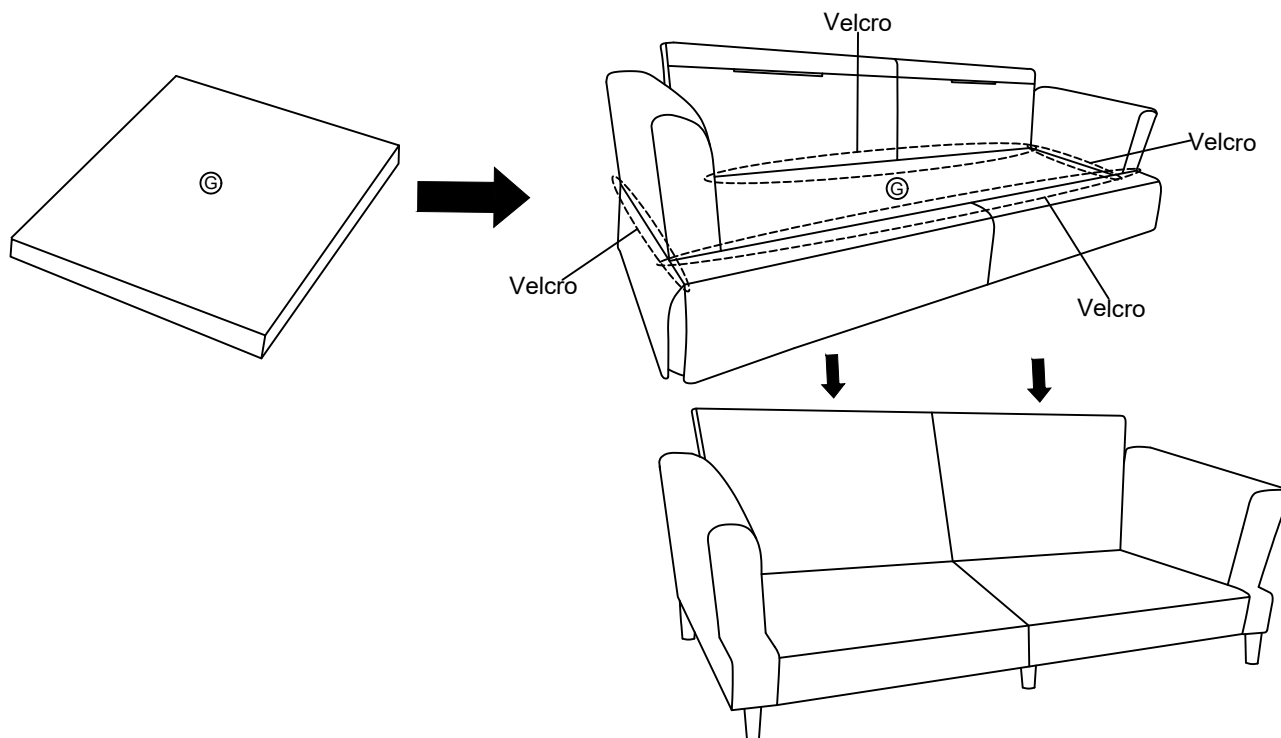

STEP 7:

Put the cushion (H&I) on the pedestal.

Note: Please kindly remove the cover tape from the velcro before placing the cushion.

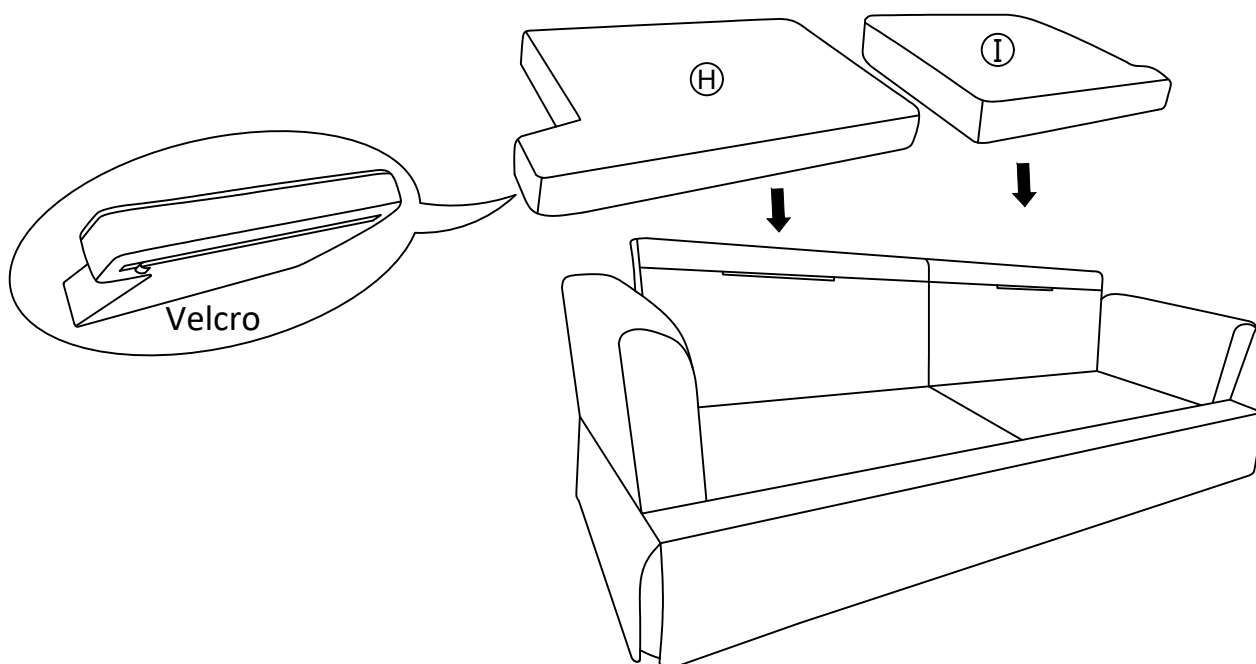

STEP 8:

Install the headrest metal to the headrest bag.

Note: Please kindly open the zip first and then install the metal (N) on it.

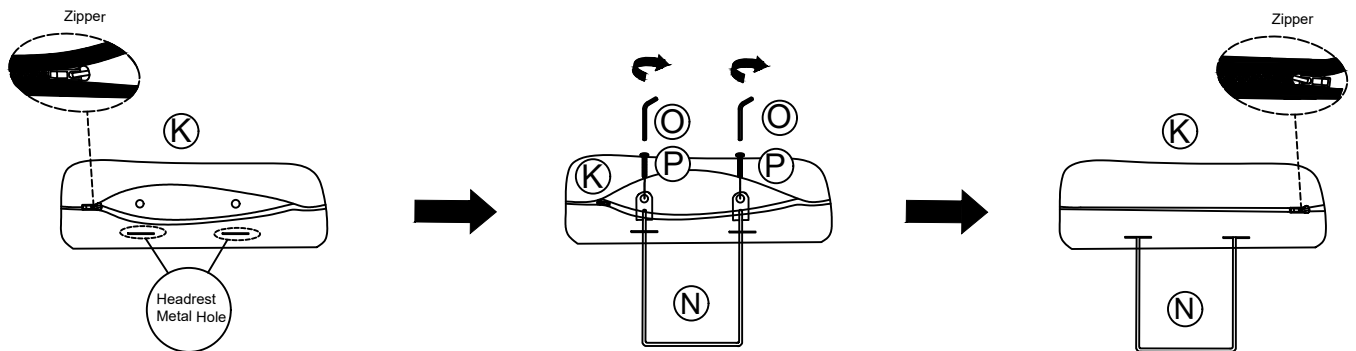

STEP 9:

Place the headrest to the backrest pocket.

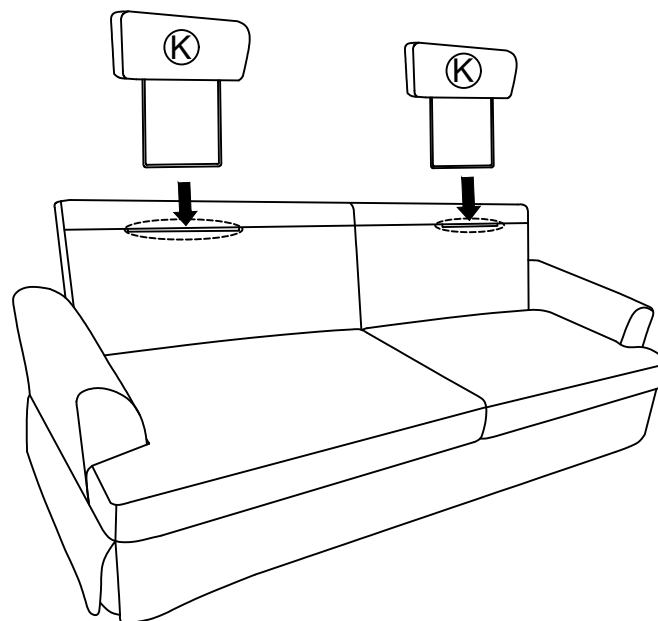

STEP 10:

Put the cushion (J) on the pedestal.

Note: Please kindly remove the cover tape from the velcro before placing the cushion.

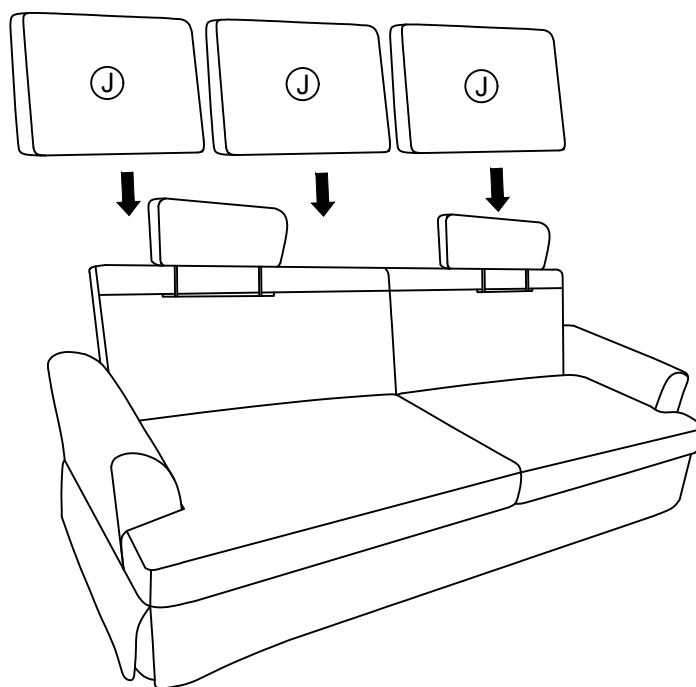

STEP 11:

Place the pillows on the sofa and decorate your sofa.

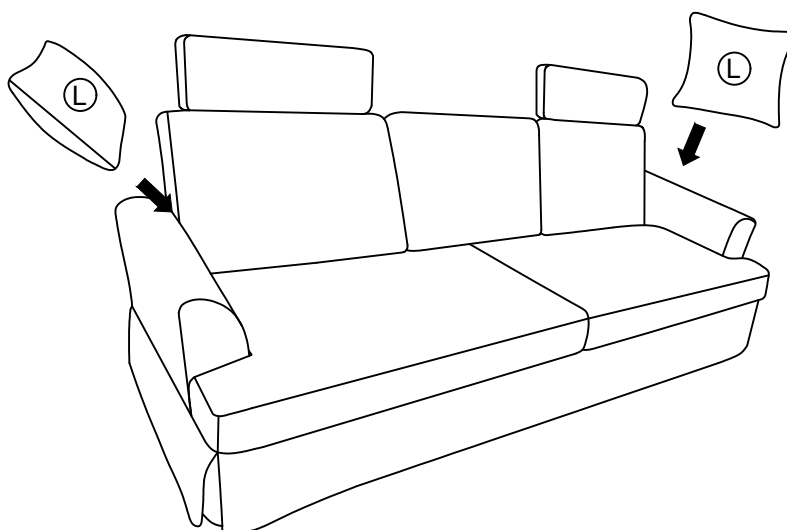

STEP 12:

Your sofa may require dressing on delivery.

Before using, please reshape the cushions to restore to its original beauty.

Note: Because of the compressed package, it will need take 48 hours to completely recovery.

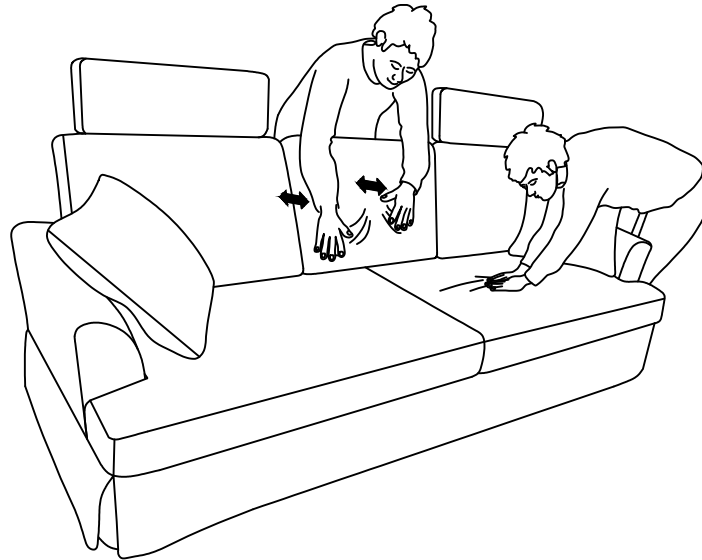

STEP 13:

The sofa has been installed, and you can start enjoying your leisure time.

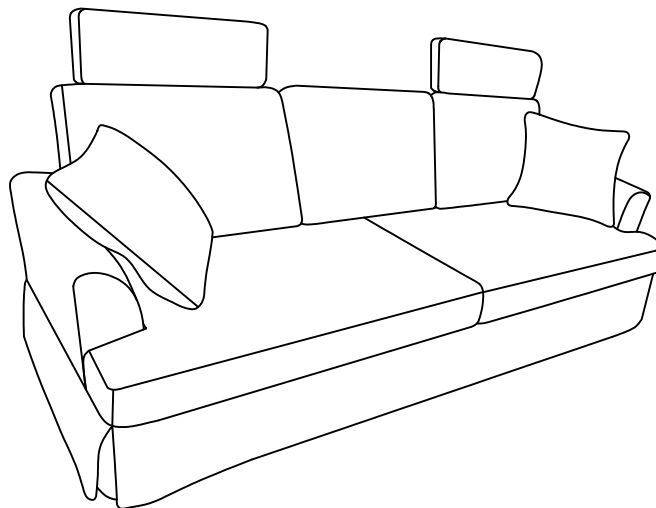

If you need more assistance on our sofa (especially with sofa installation), please do not hesitate to contact our email at:

Customerservice@aaqzhk.com

Thank you so much for your purchase. Wish you have a good day!^_^