



furnishing better lives together [®]

WWW.JOFRAN.COM

ASSEMBLY INSTRUCTIONS & PARTS IDENTIFICATION
MODEL # 2483-70
REECE 70" CONSOLE L. ASH
LIGHT ASH

Thank you for purchasing this quality product. Be sure to check all packing material carefully for small parts that may have come loose inside the carton during shipment.

KEY COMPONENTS				KEY COMPONENTS			
No.	Code	Q'ty	Description	No.	Code	Q'ty	Description
1	2483-70P07L	1 Pc	Left Side facing door	8	2483P02M	1 Pc	Middle leg
2	2483-70P07R	1 Pc	Right Side facing door	9	2483P07H	4 Pcs	Door hinge
3	2483-70P05T	1 Pc	Drawer top	10	2483P06	4 Pcs	Extension drawer glide
4	2483-70P05B	1 Pc	Drawer bottom	11	2483P08P	8 Pcs	Shelf pin
5	2483-70P08	2 Pcs	Shelf	12	2483P01L	5 Pcs	Levelers
6	2483P02	4 Pcs	Leg	13	2483P01AT	1 Kit	Anti-tip kit
7	2483P01W	4 Pcs	Plastic washer				

- With two people carefully place the cabinet on a flat surface to prevent scratches.
- Proceed to put the plastic washers on the legs and attach the legs to the cabinet, rotate the legs clockwise until tight. Align the legs so that they are in the correct direction with the product.

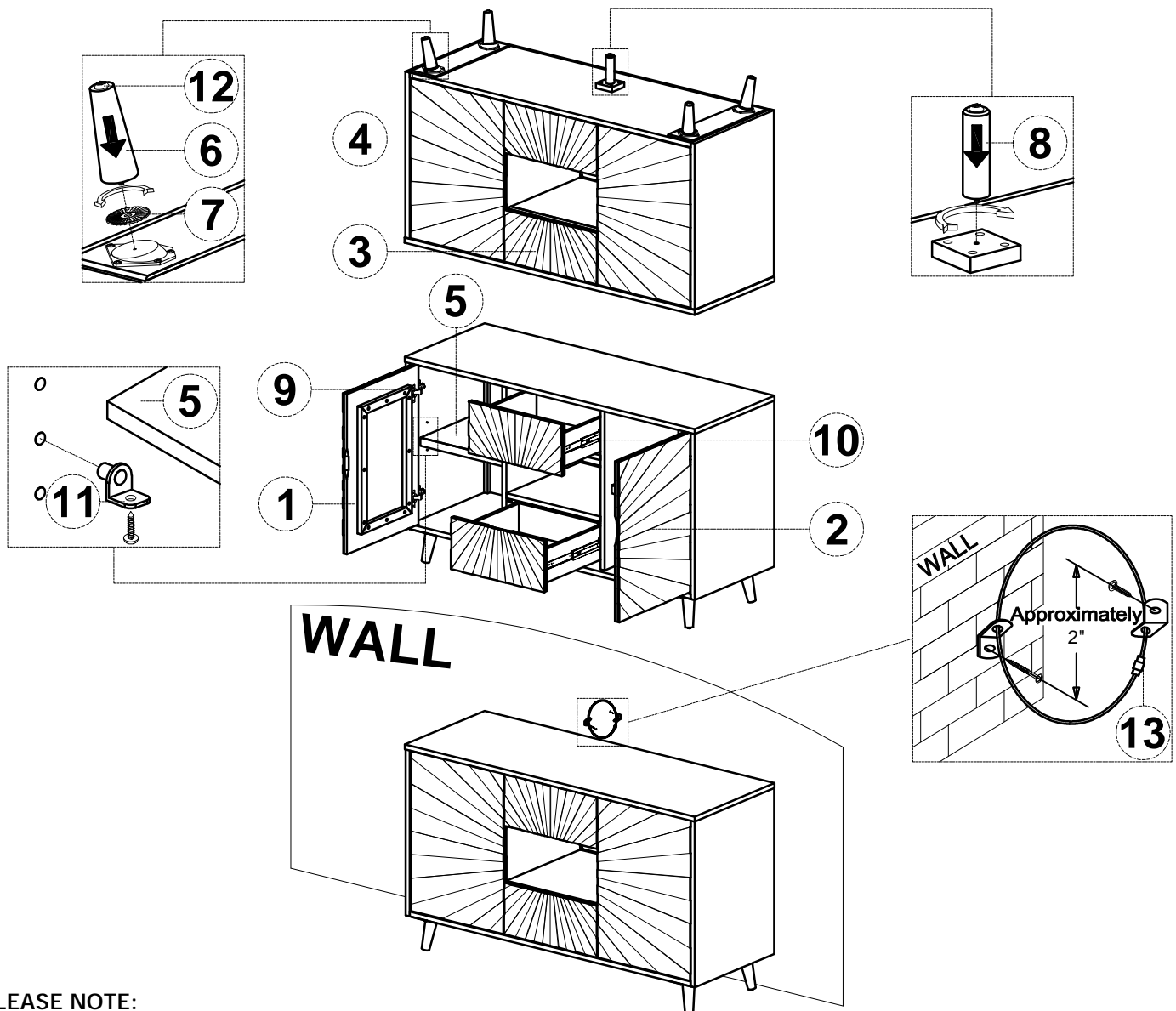

PLEASE NOTE:

To help prevent the possibility of tip-over, install the ANTI-TIP OVER restraint provided.

MADE IN VIETNAM