

Reminders

1. Use only the hardware supplied.
2. Do not over-tighten bolts.
3. This item may require periodic tightening.

ASSEMBLY INSTRUCTIONS

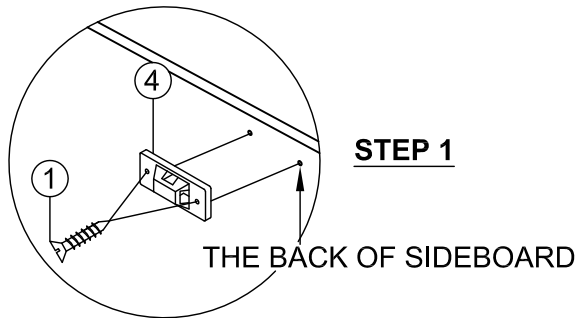

STEP 1

THE BACK OF SIDEBOARD

TO INSTALL THE SAFETY WALL STRAP

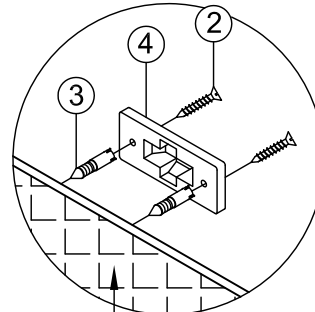

WALL

STEP 2

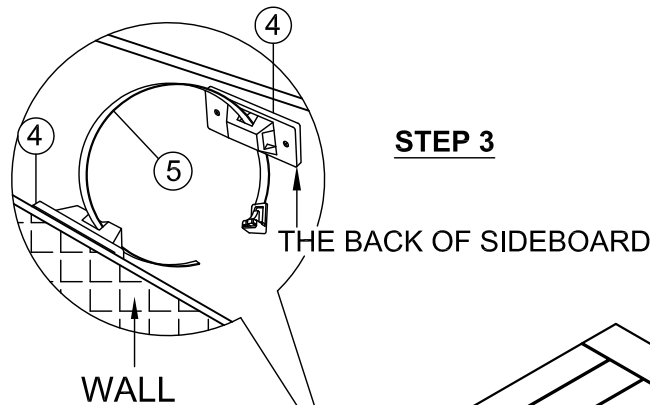

STEP 3

THE BACK OF SIDEBOARD

WALL

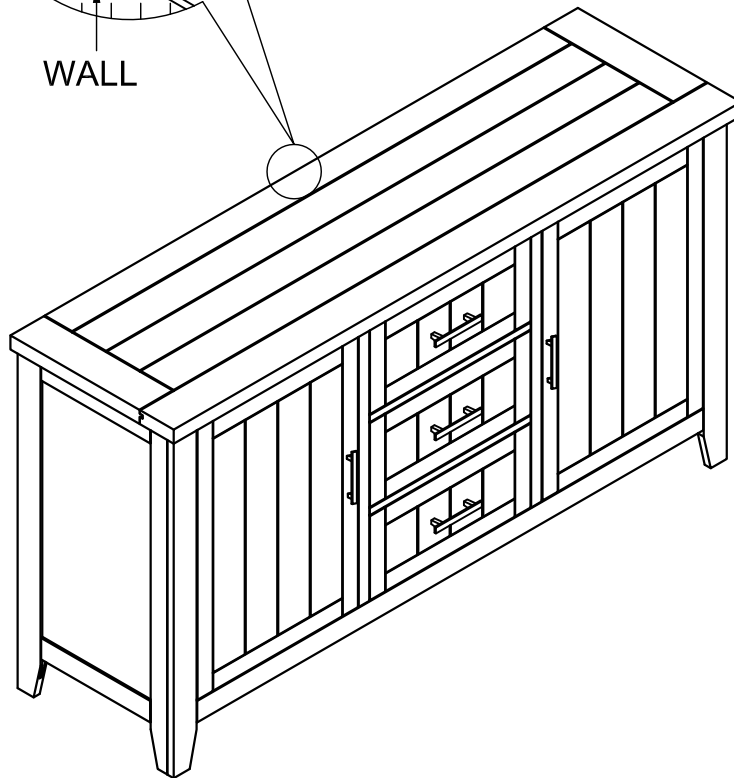

Thank you for purchasing this quality product. Be sure to check all packing material carefully for small parts that may have come loose inside the carton during shipment.

1 OF 2

① Screw
($\phi 7^* \phi 3.5^* 16$)

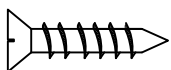

2 PCS

② Screw
($\phi 7^* \phi 3.5^* 25$)

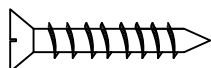

2 PCS

③ Wall Mounts



2 PCS

④ Mounting Plates

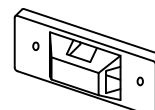



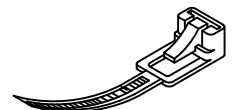

2 PCS

⑤ Secure Band

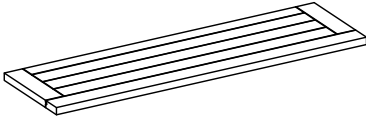
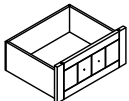
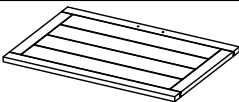
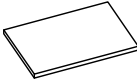
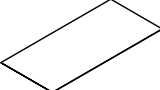
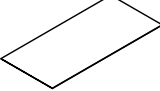

1 PC

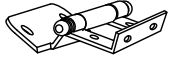
Components List

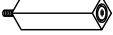
PART NO	FIGURE	DESCRIPTION	QTY
A		Top Panel	1pc
B		Drawer	3pcs
C		Door	2pcs
D		Shelf	2pcs
E		Side Back panel (710*544*3mm)	2pcs
F		Middle Back panel (710*507*3mm)	1pc
G		Handle	5pcs
H		Bolt	10pcs
I		Door Hinge	4pcs
J		Shelf Supporter	8pcs
K		Door Catch	2pcs
L		Center Support Leg With Leveler	1pc

