

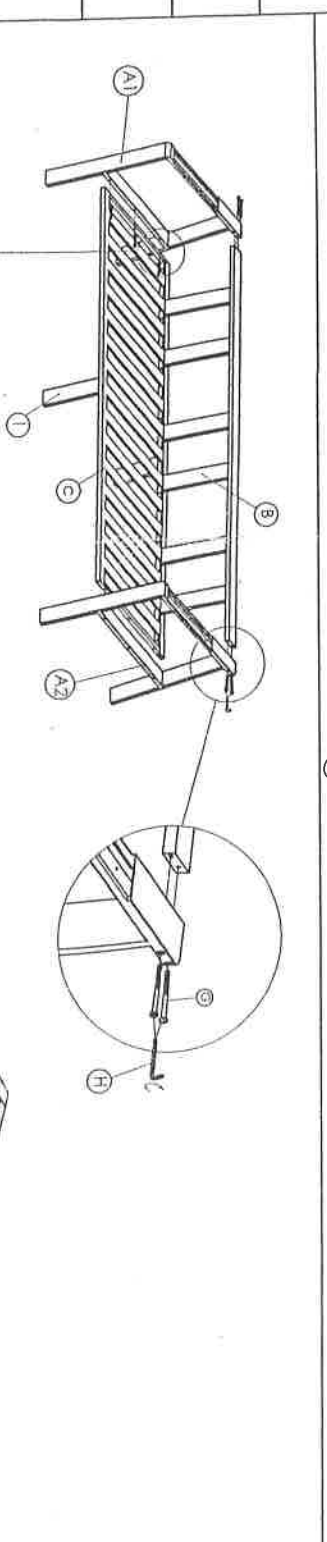

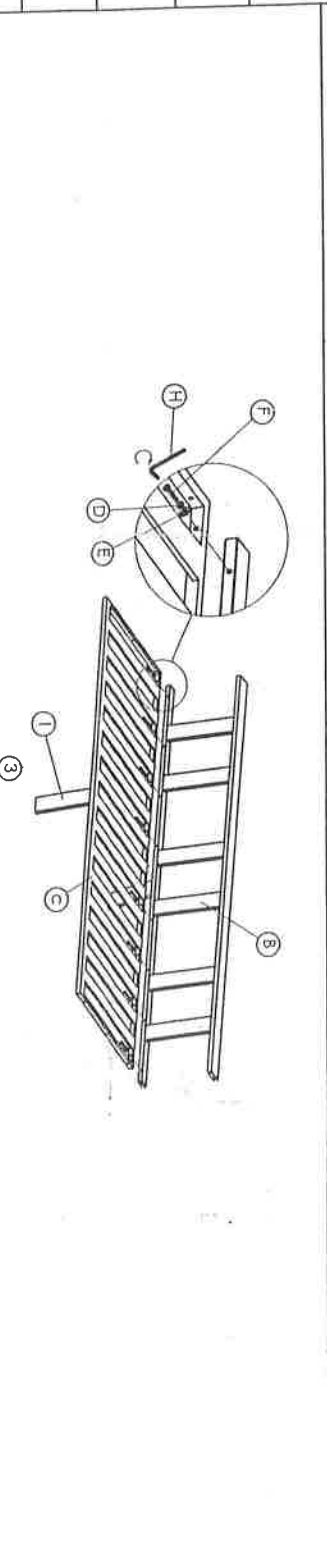

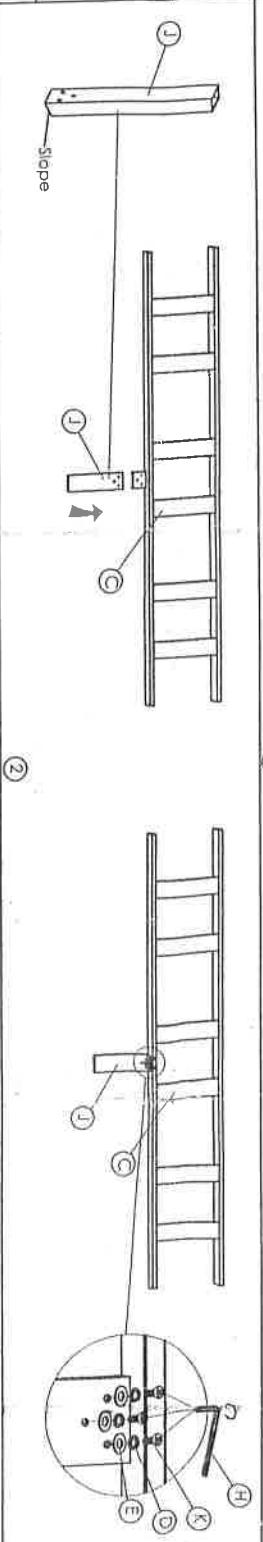

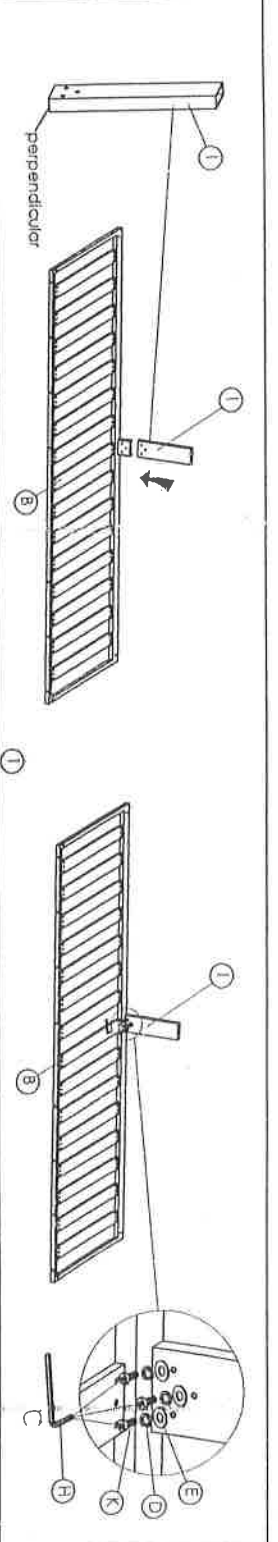

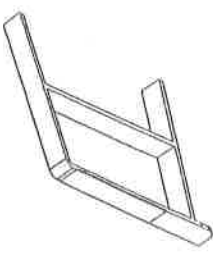
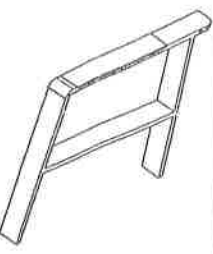
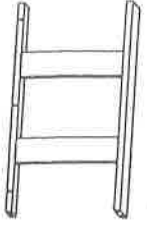
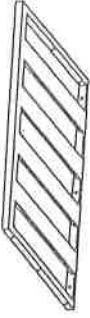



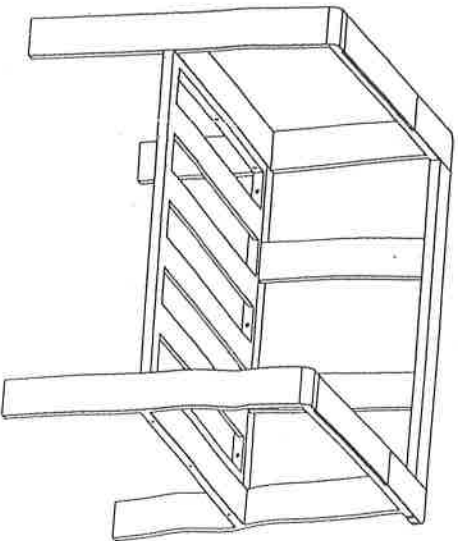
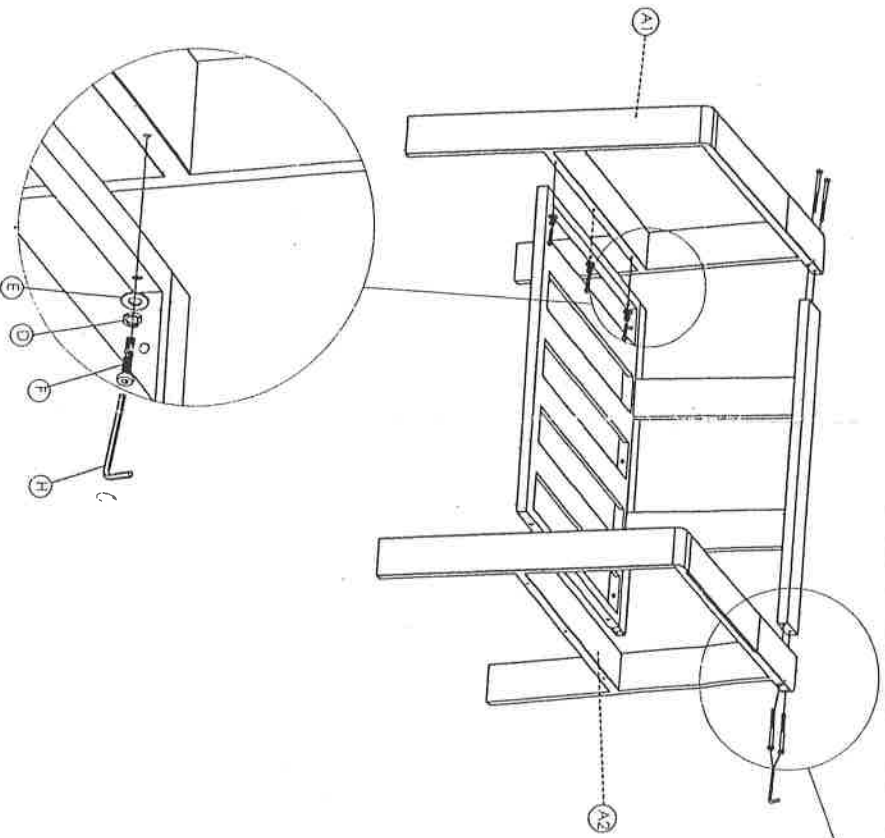
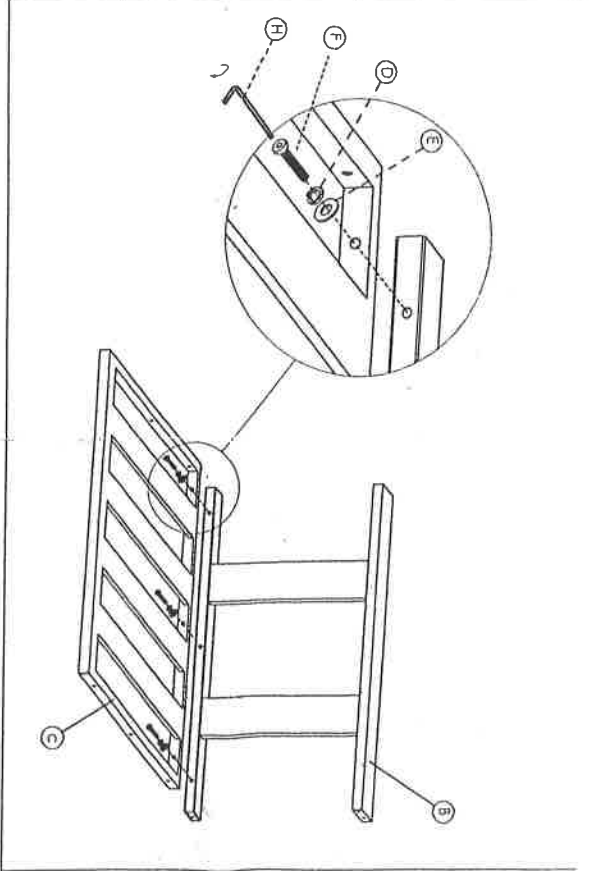
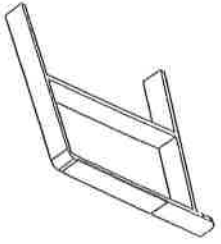

A1		X1
A2		X1
B		X1
C		X1
D		X20
E		X20
F		X14
G		X4
H		X1
I		X1
J		X1
K		X6

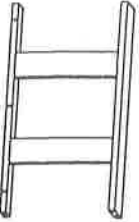

A1		X1
A2		X1
B		X1
C		X1
D	 1/4	X9
E	 1/4	X9
F	 1/4*35	X9
G	 D11*90*1/4	X4
H	 1/4	X1



A1		X1
A2		X1
B		X1
C		X1
D	 1/4	X9
E	 1/4	X9
F	 1/4*35	X9
G	 D11*90*1/4	X4
H	 1/4	X1

