

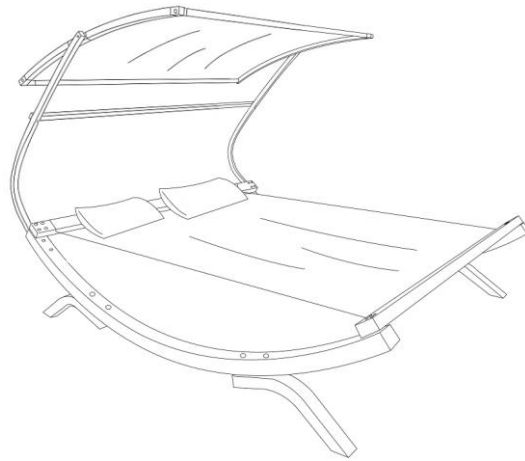







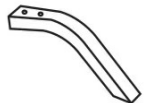

Assembly Instructions

Wooden Sun Lounger

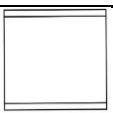
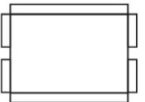

Caution : Do Not Swing on or in hammock. This could cause the product to tip over resulting in possible injury.

Parts List

Label	Picture	Description	QTY
A		Bottom Supporting Bar	2
B		Attach Leg	4
C		Bed Bar	2
D		Side Supporting Bar	2
E		Canopy Supporting Bar	1
F		Canopy End Bar	2
G		Canopy Arch Bar	2
H		Outdoor Mesh Bed Fabric	1
I		Canopy	1
J		Pillow	2

Hardware

Label	Picture	Description	QTY
①		Bolt(M10x140MM)	8
②		Bolt(M8x100MM)	16
③		Bolt(M8x60MM)	3
④		Bolt(M6x45MM)	5
⑤		Nut	9
⑥		Washer	17
⑦		Bolt Cap	25
⑧		Wrench	2
⑨		Handle	2
⑩		Allen Wrench	1
⑪		Bigger Allen Wrench	2
⑫		Bolt (M8X50MM)	3
⑬		Bolt (M8X90MM)	4

Assembly Preparation

Before Beginning Assembly:

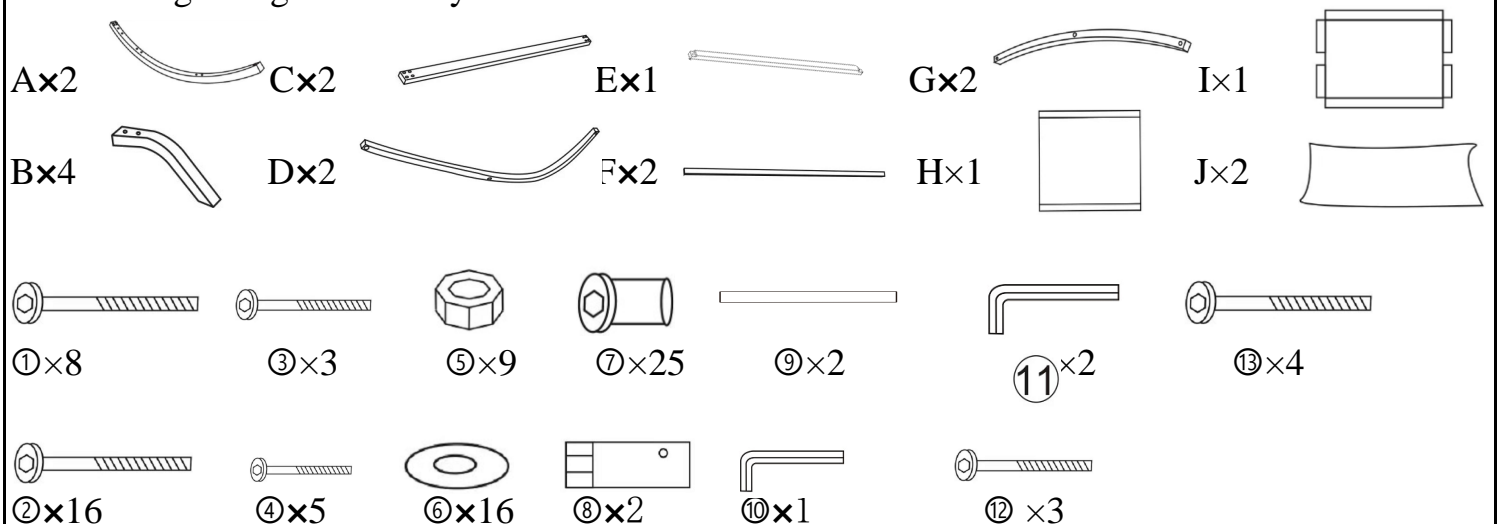



- Read instructions, cover to cover-



- Have at least 3(three) adults on hand for assembly-



- Do not assemble on flooring or carpet-



- Assemble on a clean non-marring surface (packing foam)-



- Save all packaging until finished-

Assembly Steps

Overview

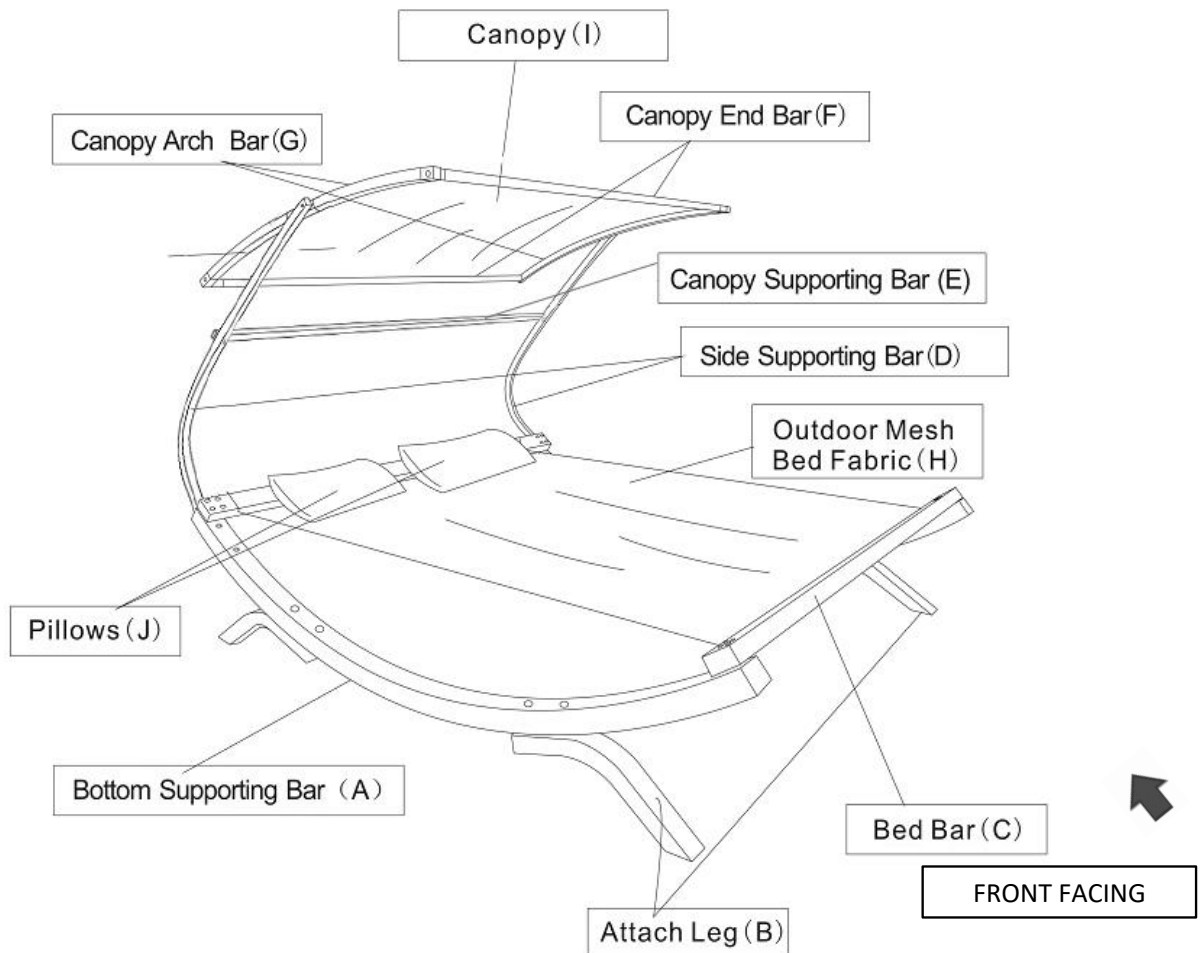

This Lounger has multiple parts and may require up to 90 minutes to assemble. To give you an overview of the Lounger parts, the above picture is to help you put the various parts into perspective. Please read through the instructions below to familiarise yourself with the parts and steps before assembly.

NOTE: 2 OR 3 PEOPLE ARE RECOMMENDED TO ASSEMBLE THIS LOUNGER.

Step 1

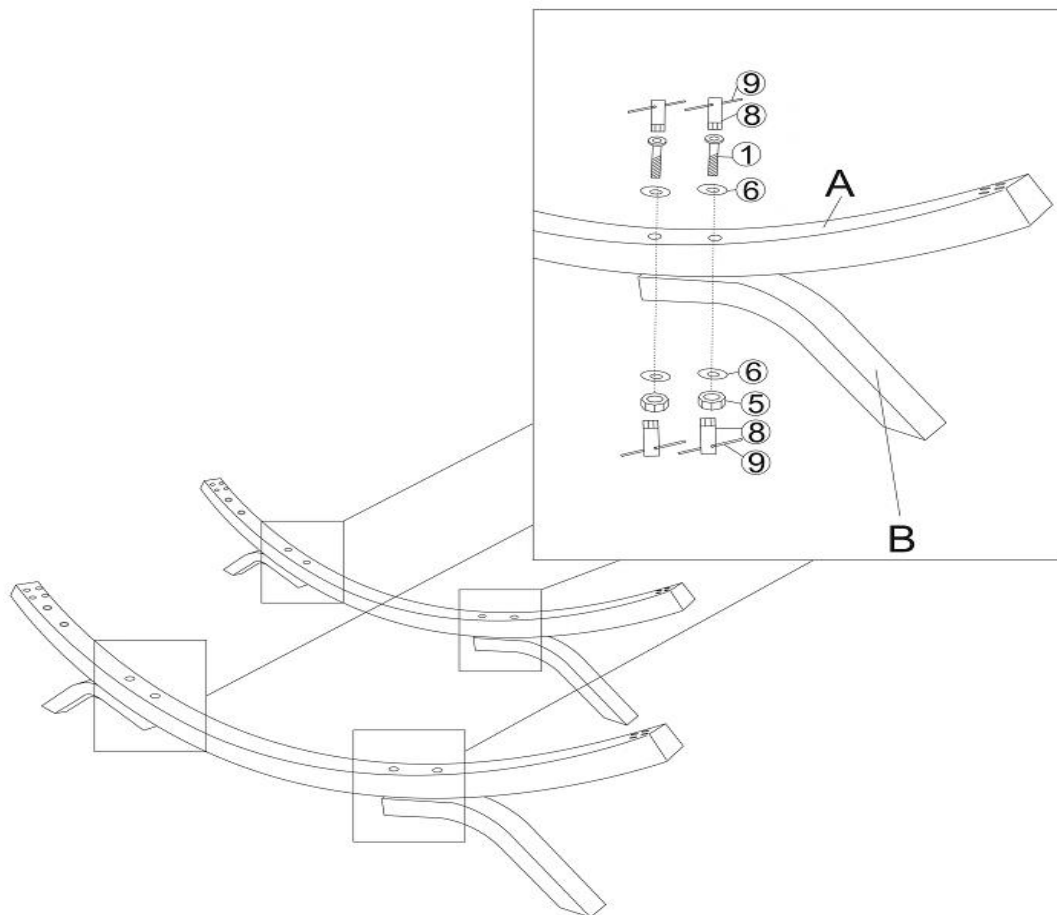

Attach Leg(B) to Bottom Supporting Bar(A) using Hardware(①,⑤,⑥) with Handle(⑨) and Wrench(⑧). Repeat this process with the other Bottom Supporting Bar(A).
Do not fully tighten Bolts.

Step 2

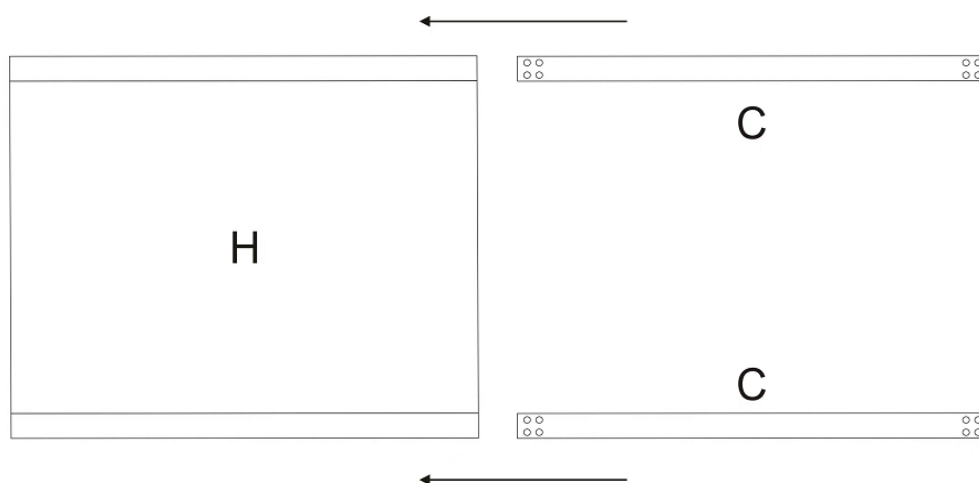

Insert the two Bed Bar(C) into the two side pockets of Outdoor Mesh Bed Fabric (H).

Step 3

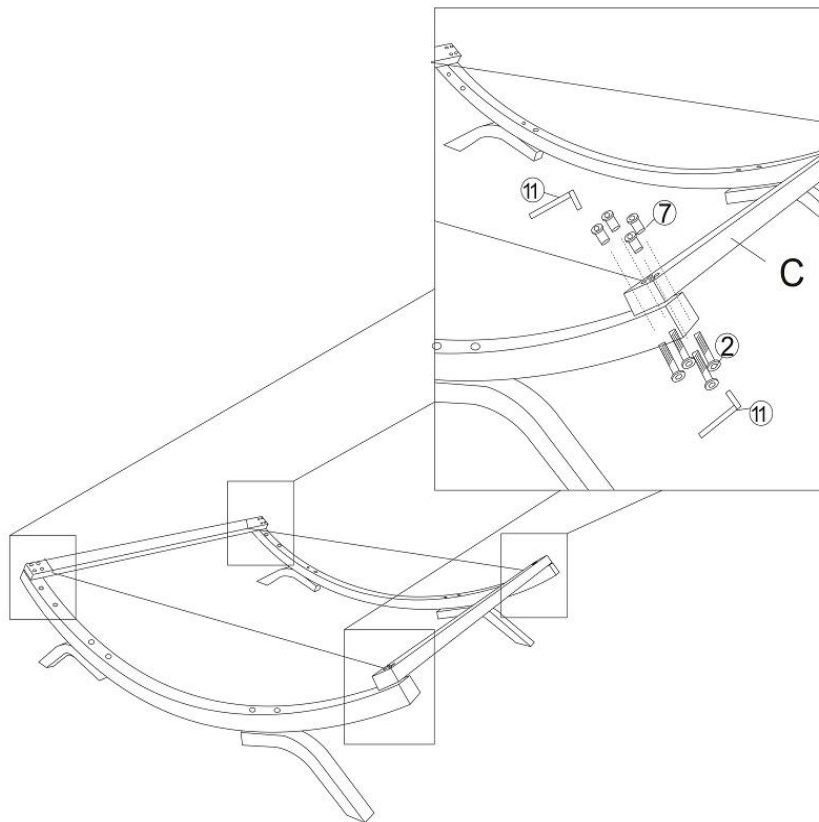

Attach Bed Bar(C) to the two Bottom Supporting Bars(A) using Hardware(②,⑦) with Bigger Allen Wrench(⑪).

Do not fully tighten Bolts.

Step 4

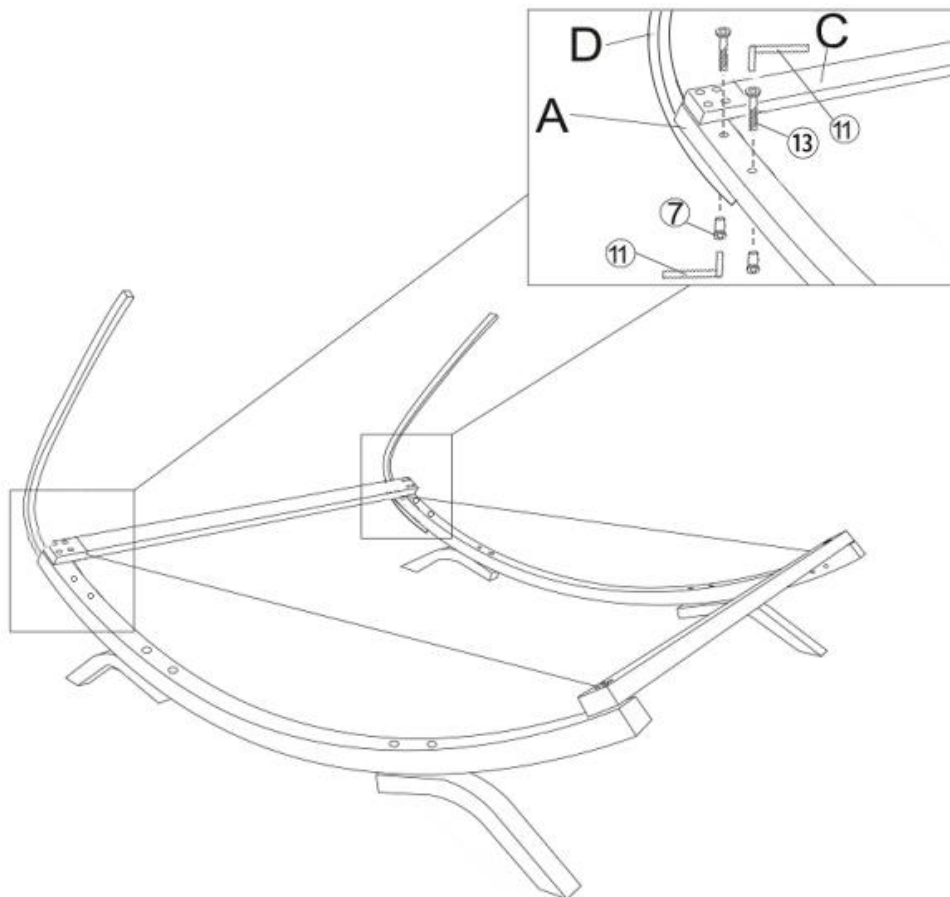

Attach the two Canopy Side Supporting Bars(D) to the Bottom Supporting Bar(A) using Hardware(⑦, ⑬) with Bigger Allen Wrench(⑪).

Do not fully tighten Bolts.

Step 5

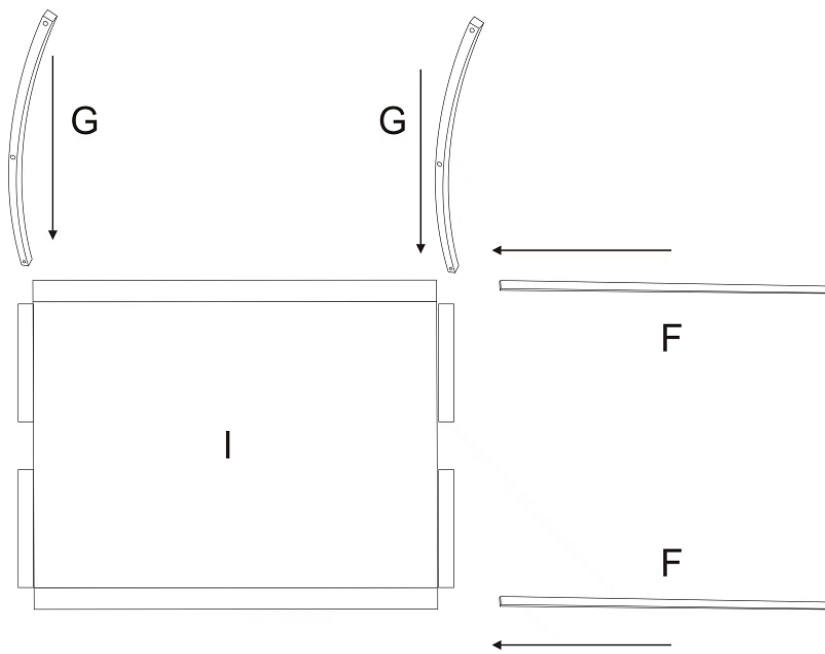

Insert two Canopy Arch Bars(G) and two Canopy End Bars(F) into the Canopy(I) .

Step 6

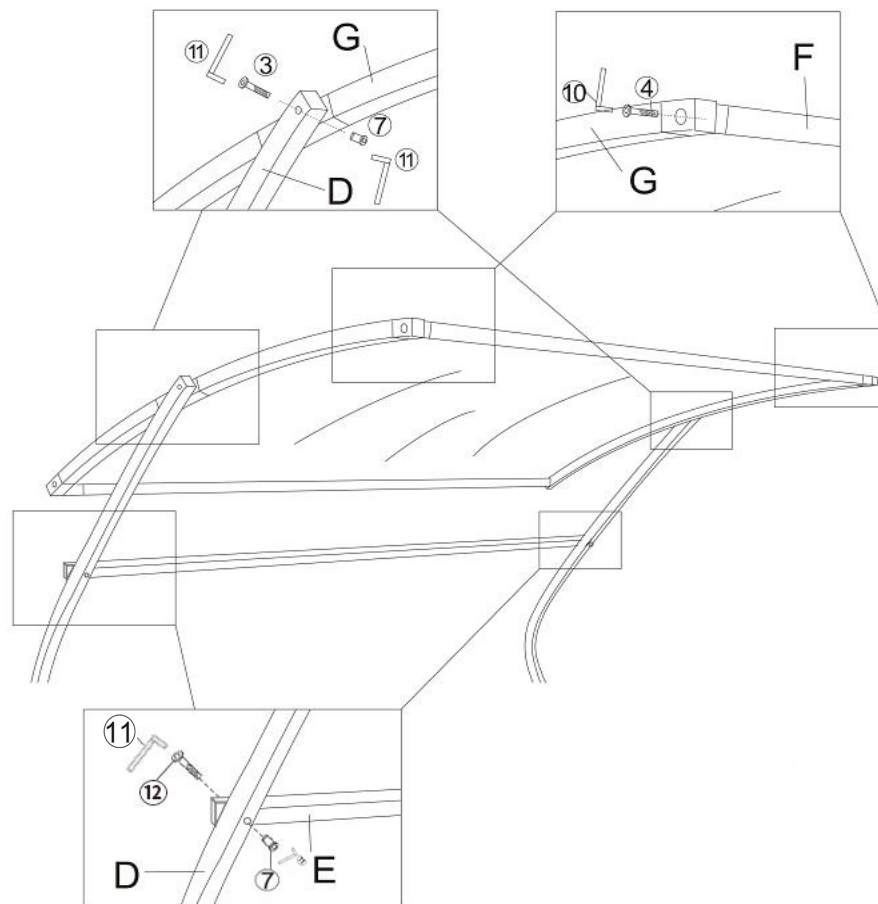

Step 6.1 Attach the Canopy End Bar(F) to the Canopy Arch Bar(G) using Bolt(④) with Allen Wrench(⑩) .

Step 6.2 Attach the Canopy Arch Bar(G) to the Canopy Side Supporting Bar(D) using Bolt(③) and Bolt Cap(⑦) with Bigger Allen Wrench(⑩).

Step 6.3 Attach the Canopy Supporting Bar(E) to the Canopy Side Supporting Bar(D) using Bolt(⑫) and Bolt Cap(⑦) with Allen Wrench(⑩) .

NOW, proceed to tighten ALL the bolts at ALL joints.



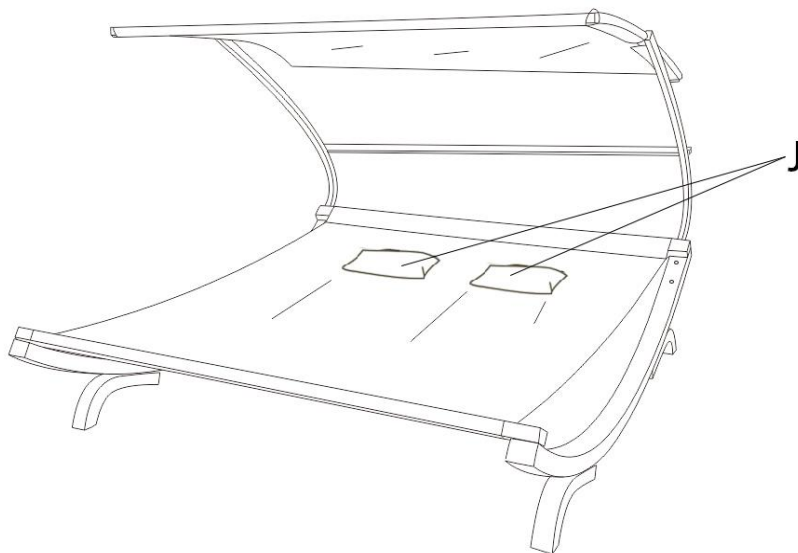





Step 7

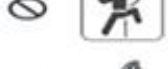

Place the two Pillows(J) on the bed.
Your Sun Lounger is ready for use.

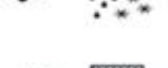
Caution: Please be careful when getting on and off the Lounge.
Children must be supervised at all times when using the Lounge.
It is NOT recommended to get on this Sun Longer from the FRONT or the BACK.

Care & Maintenance

-  ● Do not put hot items directly on furniture surface
 -  ● Do not clean furniture with harsh cleansers or polish.
 -  ● To obtain the longest lifespan of your outdoor products, minimizing exposure to direct sunlight is recommended.
 -  ● Children should not climb or jump on the furniture.
 -  ● Do not write on furniture without a padded barrier to protect the surface.
 -  ● To obtain the longest lifespan of your outdoor products, avoid extended and lengthy exposure to rain, snow, and direct sunshine. Whenever possible cover the product and /or place under patio or awnings.
 -  ● Not for commercial use. For residential use only .
 -  ● Stains may be removed with mild soap solution and damp cloth.
-
-  ● Dust and pick-up spills using a clean, non-colored, lint-free cloth .