

SWING SET

ASSEMBLY INSTRUCTION



The safety of your children is our primary concern! Please read the manual carefully before assembly. Keep this instruction for future reference.

CONTENTS

02 Safety Instruction

06 Maintenance Instruction

07 Part List

10 Assembly Instruction

10 Step 1: Swing Frame Assembly

13 Step 2: Climbing Ladder Assembly

15 Step 3: Climbing Net Assembly

18 Step 4: Trapeze Bar & Belt Swing Assembly

19 Step 5: Saucer Swing Assembly

21 Step 6: Ground Stake Assembly

22 Double Check And Tighten Bolts



NOTE:

Your Children's Safety Is Our #1 Concern!

Observe the following statements and warnings to reduce the likelihood of serious or fatal injury. Please review these safety rules regularly with your children.



WARNING! BURN HAZARD

- Pay special attention to plastic and metal surfaces as they may be hot enough to cause burns.
- Always check the temperature of the product before letting your children play on it.
- Remember that the product may cause burns if left in direct sunlight.
- Always be aware of the sun and weather conditions, and do not assume that the equipment is safe because the air temperature is not very high.

SAFETY INSTRUCTIONS

The Safety Of Your Children Is Our Primary Concern!

- The swing set is not intended for public use ONLY intended for domestic use.
- All who participate in the assembly process should wear safety glasses throughout the assembly.
- Children **MUST NOT** use this swing set until the unit has been completely assembled.
- Not suitable for children below 3 years of age. Risk of strangulation!
- Children below 3 years of age are still unable to maintain their balance.
- Since children have different development patterns, please check beforehand if your child is able to maintain his balance.
- **DO NOT** allow children to walk close to, in front of, behind, or between moving swings or other moving playground equipment.
- Instruct children to avoid swinging empty seats.
- Teach children to sit in the center of the swings with their full weight on the seats, never stand or kneel on the swing seat.
- Instruct children Not to get off the swing while it is in motion.
- The recommend height from the ground to swing seat is 20in(50cm).
- Maximum 5 players at a time on the swing. Individual weight maximum of 110lbs.
- On-site, continuous adult supervision is **REQUIRED** for children for all ages. **MOST SERIOUS INJURIES AND DEATHS ON PLAYGROUND EQUIPMENT HAVE OCCURRED WHILE CHILDREN WERE UNSUPERVISED!**

- Children should NOT twist the chains and ropes and should not loop them over the top support bar, this could reduce the strength of the chain or rope.
- Children Not to use the equipment in a manner other than intended
- DO NOT allow children to walk close to, in front of, behind, or between moving swings or other moving playground equipment.
- DO NOT let children stand on swings.
- DO NOT allow children to wear inappropriate items, such as but not limited to, loose fitting clothing, hood and neck drawstrings, scarves, cord-connected items, capes and ponchos. These items can cause death by strangulation.
- DO NOT let Children attach items to the playground equipment that are not specifically designed for use with the equipment, such as, but not limited to, jump ropes, clothesline, pet leashes, cables and chain as they may cause a strangulation hazard.
- Instruct children to remove their bike or other sports helmet before playing on playground equipment.
- Dress children with wellfitting and full foot enclosing footwear. Examples of inappropriate footwear are clogs, flip flops, and sandals.
- NEVER add extra length to chain or rope. The chains or ropes provided are the maximum length designed for the swinging element(s).
- Instruct children NOT to get off equipment while it is in motion.
- DO NOT allow children to crawl on top of a frame or side bar.
- The maximum fall height of the product is 71 inch.

Positioning Your Playcenter

- The playcenter is designed to be installed on a level surface by an adult with an adult helper. Place in a flat area of your yard to minimize ground preparation.
- Choose a level location for the equipment. This can reduce the likelihood of the play set tipping over and loose-!ll surfacing material washing away during heavy rains.
- Place the equipment not less than 6 ft (1.8 m) from any structure or obstruction such as a fence, garage, house, overhanging branches, laundry lines, or electrical wires.
- Provide enough room so that the children can use the equipment safely. For example, for structures with multiple play activities, a slide should not exit in front of a swing.
- It is a good idea to place your playcenter in an area that is convenient for adults to watch children at play.
- Create a site free of obstacles that could cause injuries – such as low overhanging tree branches, overhead wires, tree stumps and/or roots, large rocks, bricks and concrete. Additional suggestions in the Suggested Playground Surfacing Section.
- Do not build your playset on top of surfacing material.
- Locate bare metal platforms and slides out of direct sunlight to reduce the likelihood of serious burns. A slide that faces north will receive the least direct sunlight.
- Separate active and quiet activities from each other. For example, locate sandboxes away from swings or use a guardrail or barrier to separate the sandbox from the movement of the swings.

Suggested Playground Surfacing

- Do not install home playground equipment over concrete, asphalt, packed earth, grass, carpet, or any other hard surface. A fall onto a hard surface can result in serious injury to the equipment user.
- Do not install loose fill surfacing over hard surfaces such as concrete or asphalt.
- Shredded bark mulch, wood chips, fine sand and fine gravel, are added as shock absorbing materials after assembly. If used properly these materials can absorb some of the impact of a child's fall.
- All surface material should extend a minimum of 6ft(1.8m) feet in all directions around the play area.
- Do not apply playground surfacing until after the unit is completely constructed. Playset should not be built on top of surfacing.
- Use containment, such as digging out around the perimeter and/or lining the perimeter with landscape edging.
- Installations of rubber tiles or poured-in-place surfaces (other than loose-fill materials) generally require a professional and are not "do-it-yourself" projects.
- Shall use Playground Surfacing Materials (other than loose-fill material) which comply with the safety standard ASTM F1292 Standard Specification of Impact Attenuation of Surfacing Materials within the Use Zone of Playground Equipment.

The following chart explains the fall height in feet from which a life threatening head injury would not be expected

Critical Heights in feet (m) of Tested Materials

Material	Uncompressed Depth			Compressed Depth
	6" (152mm)	9" (228mm)	12" (304mm)	to 9" (228mm)
Wood Chips	7' (2.13m)	10-12' (3.0-3.6m)	11' (3.35m)	10' (3.05m)
Double-Shredded Bark Mulch	6' (1.83m)	10-12' (3.0-3.6m)	11' (3.35m)	7' (2.13m)
Engineered Wood Fibers	6' (1.83m)	7' (2.13m)	>12' (3.66m)	6' (1.83m)
Fine Sand	5' (1.52m)	5' (1.52m)	9' (2.74m)	5' (1.52m)
Coarse Sand	5' (1.52m)	5' (1.52m)	6' (1.83m)	4' (1.22m)
Fine Gravel	5' (1.52m)	7' (2.13m)	10' (3.05m)	6' (1.83m)
Medium Gravel	5' (1.52m)	5' (1.52m)	6' (1.83m)	5' (1.52m)
Shredded Tires*	10-12' (3.0-3.6m)	N/A	N/A	N/A

*This data is from tests conducted by independent testing laboratories on a 6-inch depth of uncompressed shredded tire samples produced by four manufacturers. The tests reported critical heights, which varied from 10 feet to greater than 12 feet. It is recommended that persons seeking to install shredded tires as a protective surface request test data from the supplier showing the critical height of the material when it was tested in accordance with ASTM F1292.

The following information is from the United States Consumer Product Safety Commission's Information Sheet for playground surfacing material; also see the following website for additional information: www.cpsc.gov

Select Protective Surfacing—One of the most important things you can do to reduce the likelihood of serious head injuries is to install shock-absorbing protective surfacing under and around your play equipment. The protective surfacing should be applied to a depth that is suitable for the equipment height in accordance with ASTM Specification F 1292. There are different types of surfacing to choose from; whichever product you select, follow these guidelines:

Loose-Fill Materials:

Maintain a minimum depth of 9 inches of loose-fill materials such as wood mulch/chips, engineered wood fiber(EWF), or shredded/recycled rubber mulch for equipment up to 8 feet high; and 9 inches of sand or pea gravel for equipment up to 5 feet high. **NOTE:** An initial fill level of 12 inches will compress to about a 9-inch depth of surfacing overtime. The surfacing will also compact, displace, and settle, and should be periodically refilled to maintain at least a 9-inch depth.

Use a minimum of 6 inches of protective surfacing for play equipment less than 48 in. in height. If maintained properly, this should be adequate. (At depths less than 6 inches, the protective material is too easily displaced or compacted.)

NOTE: Do not install home playground equipment over concrete, asphalt, or any other hard surface. A fall onto a hard surface can result in serious injury to the equipment user.

Grass and dirt are not considered protective surfacing because wear and environmental factors can reduce their shock absorbing effectiveness. Carpeting and thin mats are generally not adequate protective surfacing. Ground level equipment such as a sandbox, activity wall, playhouse or other equipment that has no elevated play surface – does not need any protective surfacing.

Use containment, such as digging out around the perimeter and/or lining the perimeter with landscape edging. Don't forget to account for water drainage.

Check and maintain the depth of the loose-fill surfacing material. To maintain the right amount of loose-fill materials, mark the correct level on play equipment support posts. That way you can easily see when to replenish and/or redistribute the surfacing.

Do not install loose fill surfacing over hard surfaces such as concrete or asphalt.

Poured-In-Place Surfaces or Pre-Manufactured Rubber Tiles — You may be interested in using surfacing other than loose-fill materials – like rubber tiles or poured-in-place surfaces.

Installations of these surfaces generally require a professional and are not “do-it-yourself” projects.

Review surface specifications before purchasing this type of surfacing. Ask the installer/manufacturer for a report showing that the product has been tested to the following safety standard: ASTM F 1292 Standard Specification for Impact Attenuation of Surfacing Materials within the Use Zone of Playground Equipment. This report should show the specific height for which the surface is intended to protect against serious head injury. This height should be equal to or greater than the fall height – vertical distance between a designated play surface (elevated surface for standing, sitting, or climbing) and the protective surfacing below – of your play equipment

Check the protective surfacing frequently for wear.

Placement — Proper placement and maintenance of protective surfacing is essential. Be sure to: Extend surfacing at least 72 in. from the equipment in all directions.

For to-fro swings, extend protective surfacing in front of and behind the swing to a distance equal to twice the height of the top bar from which the swing is suspended.

For Tire swings, extend surfacing in a circle whose radius is equal to the height of the suspending chain or rope, plus 6 ft in all directions.

MAINTENANCE INSTRUCTIONS

- IT IS IMPORTANT TO CHECK AND TIGHTEN ALL HARDWARE AT THE BEGINNING AND DURING THE SEASON, otherwise the equipment may overturn and/or become a hazard.
- Do not expose the swing to the weather during longer periods of rain and in autumn / winter.
- Always replace defective parts with original spares.

At the beginning of each play season

- Tighten all hardware.
- Lubricate all metallic moving parts.
- Check all protective coverings on bolts, pipes, edges and corners. Please replace in time if they are loose, cracked or missing.
- Check all moving parts including ropes, swing seats, cables and chains for wear, rust or other deterioration.
- Check metal parts for rust. If found, sand and repaint using a nonlead-based paint meeting the requirements of 16 CFR 1303.
- Reinstall any plastic parts, such as swing seats or any other items that were removed for the cold season.
- Rake and check depth of loose fill protective surfacing materials to prevent compaction and to maintain appropriate depth. Replace as necessary.

Twice a month during play season

- Tighten all hardware.
- Check all protective coverings on bolts, pipes, edges and corners. Please replace in time if they are loose, cracked or missing.
- Rake and check depth of loose fill protective surfacing materials to prevent compaction and to maintain appropriate depth. Replace as necessary.



Once a month during play season







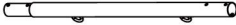
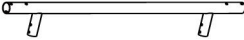
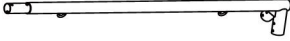

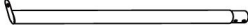

- Lubricate all metallic moving parts.
- Check all moving parts including ropes, swing seats, cables and chains for wear, rust or other deterioration.

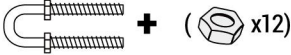

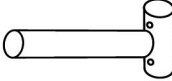



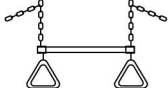

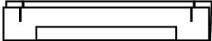



At the end of each play season or when the temperature drops below 32°F

- Remove plastic swing seats and other items and take them indoors or do not use.
- Rake and check depth of loose fill protective surfacing materials to prevent compaction and maintain appropriate depth. Replace as necessary.
- Owners shall be responsible for maintaining the legibility of the warning labels.
- Disposal Instructions—There shall be instructions advising the owner to disassemble and dispose of the playground equipment in such a way that no unreasonable hazards will exist at the time the playground equipment is discarded.

Part List

No.	PICTURE	DESCRIPTION	QTY
A1		Top Bar A1	1
A2		Top Bar A2	1
A3		Top Bar A3	1
A4		Top Bar A4	1
A5		Upper Leg	4
A6		Lower Leg	4







A7		Side Bar	2
A8		Casing Tube	1
A9		U-bolt + nut	6
B1		Tubes with Climbing Net	1
B2		Cross Bar	8
B3		T-shaped Tube	2
C1		L-shaped Tube	2
C2		Upper Tube for Monkey Bar	2
C3		Lower Tube for Monkey Bar	2
C4		Clamping Plate	4
D		Trapeze Bar	1
E		Belt Swing	1
F1		Platform Swing	1



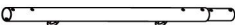

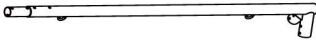
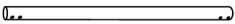

F2		Swing Rope with Eye Bolt	2
F3		U Tube with Foam for Platform Swing	2
F4		Long Tube with Foam for Platform Swing	2
G		Spanner	1
H		Allen Wrench	1
I		Carabiner	6
J1		Ground Stake	8
J2		Iron Bar	1
K1		Bolt(8mmx62mm)	4
K2		Bolt(8mmx55mm)	4
K3		Bolt(8mmx50mm)	48
K4		Washer	128
K5		Nut	68

Assembly Instruction

Tips: For easier assembly, do not over-tighten the bolts initially to leave room for adjustment. You must go back and fully tighten all bolts after the entire swing set is assembled.

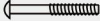
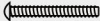
Step 1: Swing Frame Assembly (Parts and Tools Required)

No.	PICTURE	DESCRIPTION	QTY
A1		Top Bar A1	1
A2		Top Bar A2	1
A3		Top Bar A3	1
A4		Top Bar A4	1
A5		Upper Leg	4
A6		Lower Leg	4
A7		Side Bar	2
A8		Casing Tube	1
A9		U-bolt + nut	6

G		Spanner	1
H		Allen Wrench	1
K1		Bolt(8mmx62mm)	4
K2		Bolt(8mmx55mm)	4
K3		Bolt(8mmx50mm)	16
K4		Washer	64
K5		Nut	36

1.Connect A top bars in the following order as below picture and secure the joints with A8,K1, K2,K4 and K5.

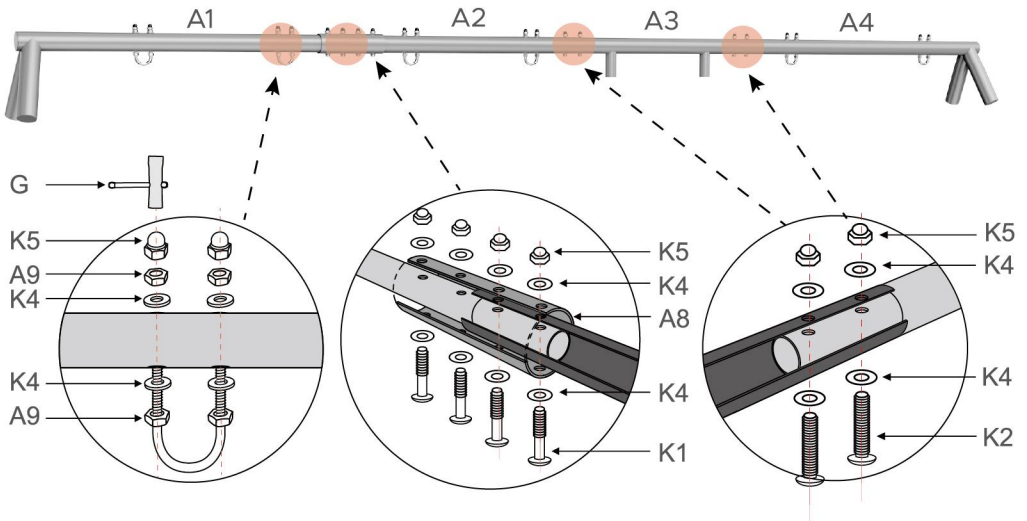

2. Connect A5 to A1 and A4 and secure with K3, K4 and K5.

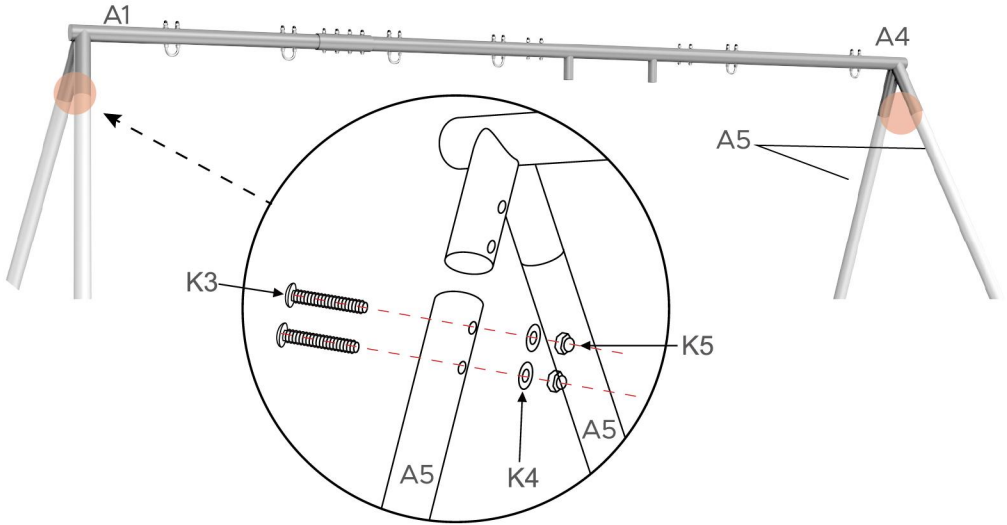



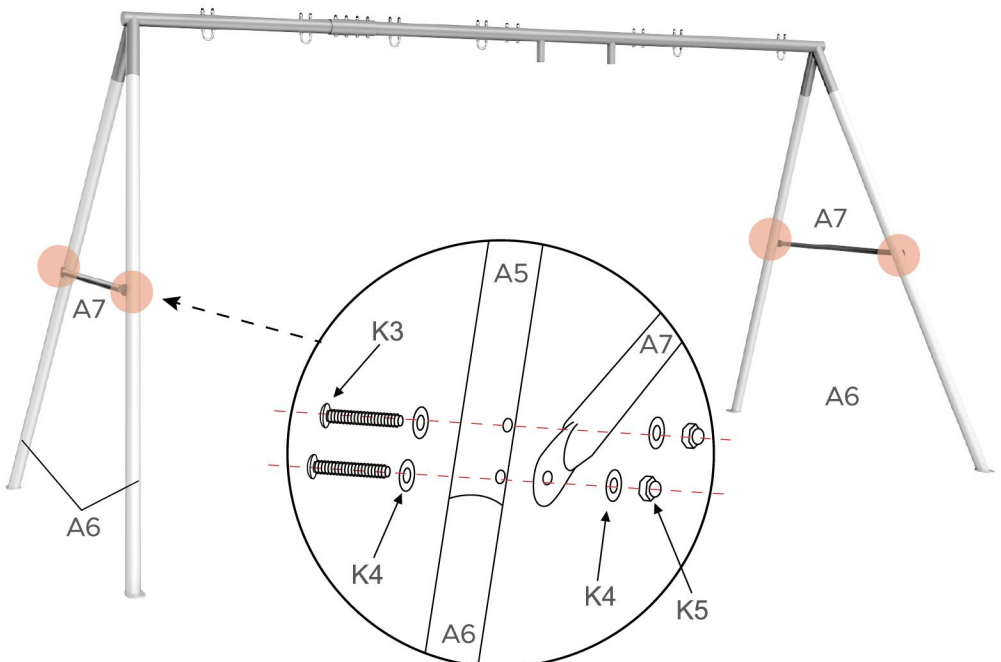



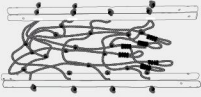

3. Connect A6 to A5, then attach A7 to the joint of A5 and A6 and secure them together with K3, K4 and K5.

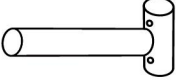

Step 2: Climbing Ladder Assembly

Parts and Tools Required

No.	PICTURE	DESCRIPTION	QTY
B1		Tubes with Climbing Net	1
B2		Cross Bar	2
B3		T-shaped Tube	2
G		Spanner	1
H		Allen Wrench	1
K3		Bolt(8mmx50mm)	12
K4		Washer	24
K5		Nut	12

1. Connect the tubes of B1 together (Do not tighten bolts in this step).

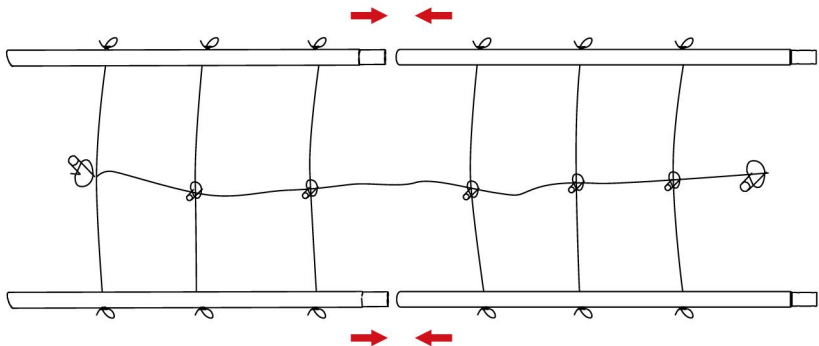

2. Connect the assembled B1 and B3 to A3 and secure with K3, K4 and K5.

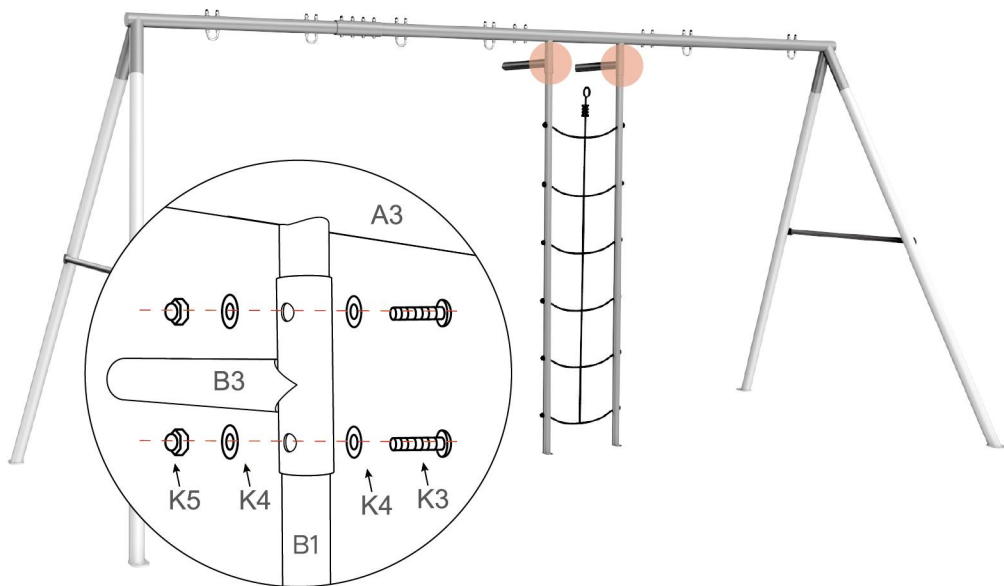



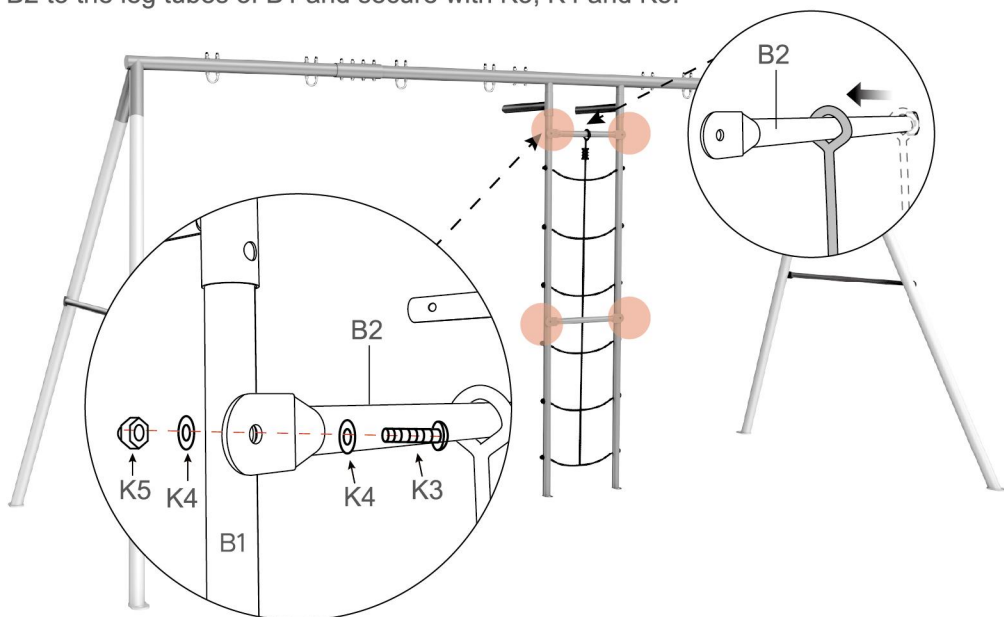



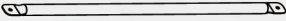
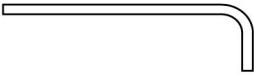

3. Thread the connectors of the climbing net onto B2, then connect the assembled B2 to the leg tubes of B1 and secure with K3, K4 and K5.



Step 3: Climbing Net Assembly

Parts and Tools Required

No.	PICTURE	DESCRIPTION	QTY
B2		Cross Bar	6
C1		L-shaped Tube	2
C2		Upper Tube for Monkey Bar	2
C3		Lower Tube for Monkey Bar	2
C4		Clamping Plate	4
G		Spanner	1
H		Allen Wrench	1
K3		Bolt(8mmx50mm)	20
K4		Washer	40
K5		Nut	20

1. Connect C2 to C3 and secure with K3, K4 and K5.

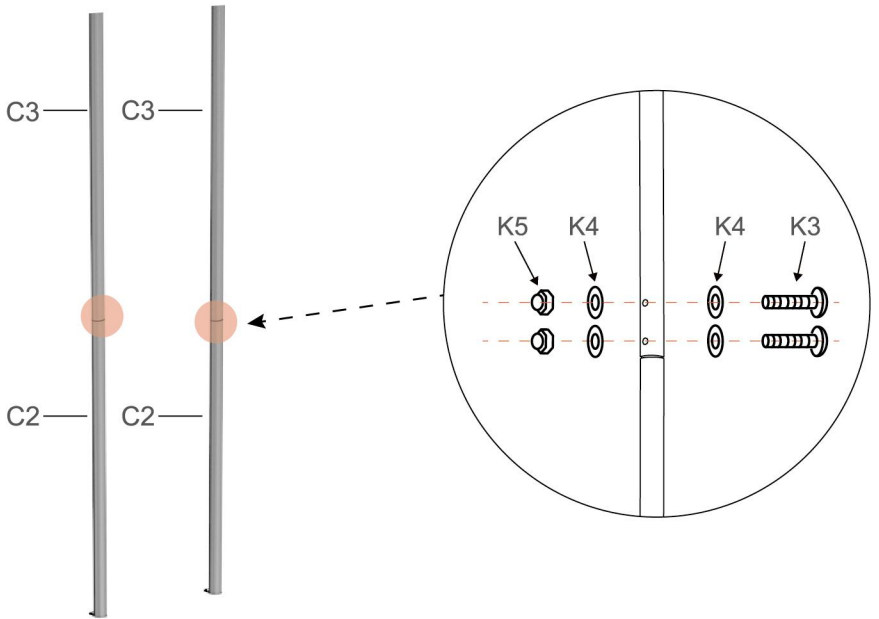

2. Connect the assembled tubes to C1 and secure with C4, K3, K4 and K5.

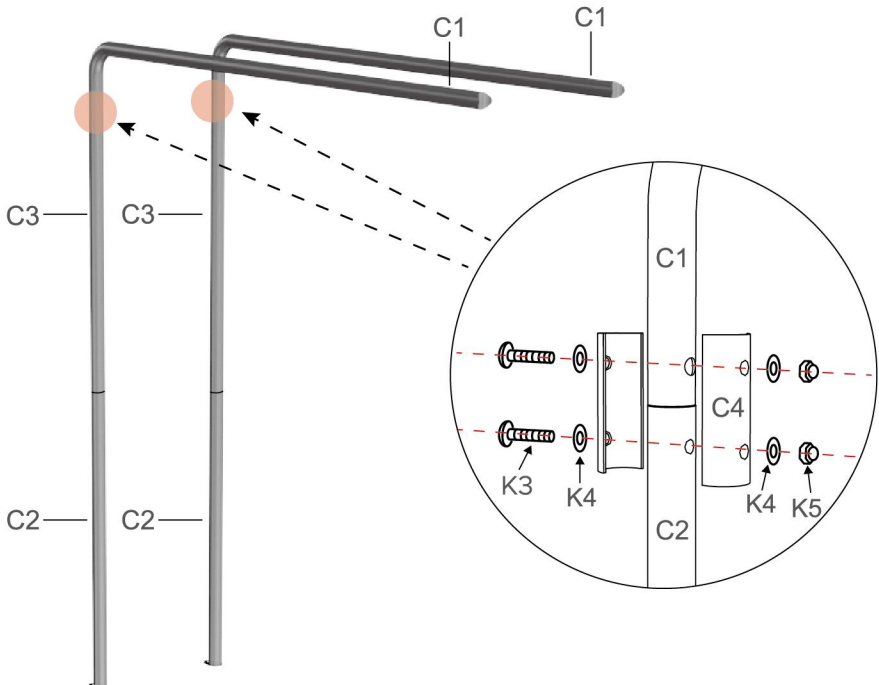

3. Connect the assembled tubes to B3 and secure with K3, K4 and K5.

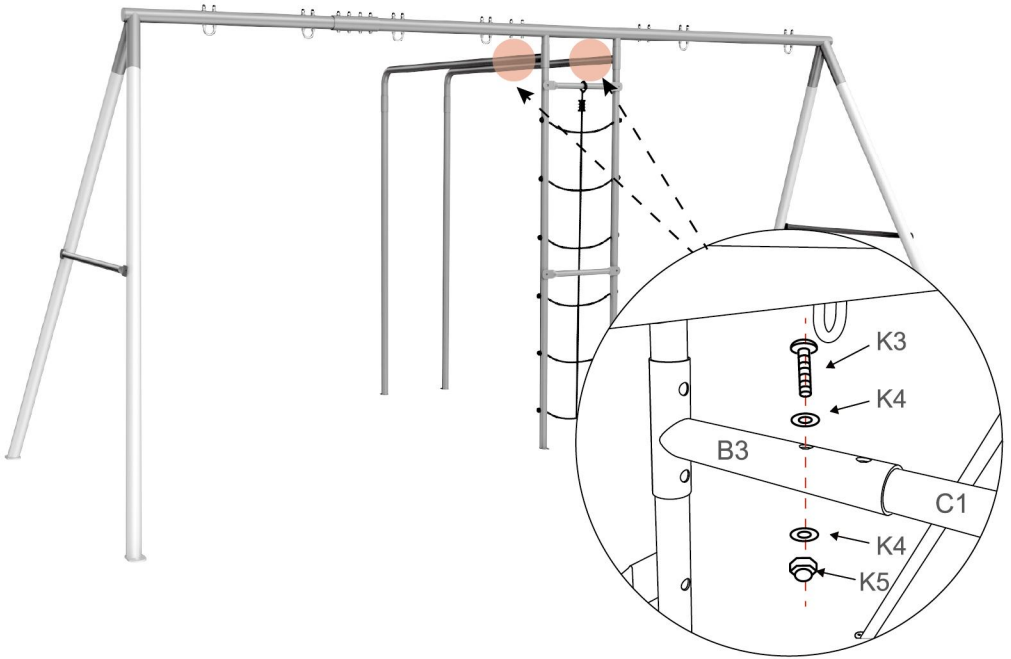

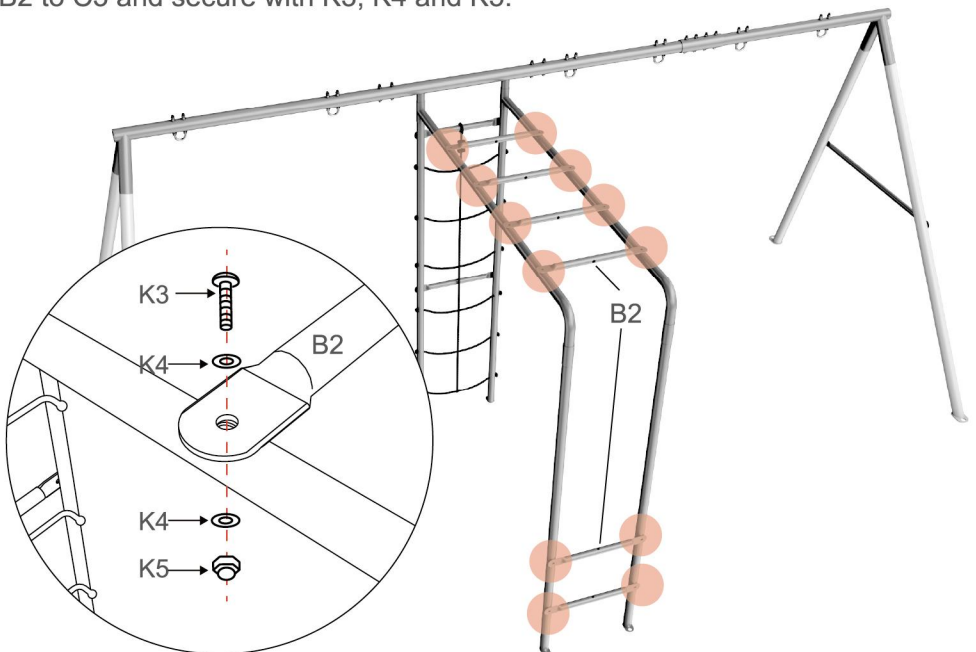

4. Connect B2 to C1 and secure with K3, K4 and K5. Connect B2 to C3 and secure with K3, K4 and K5.



Step 4: Trapeze Bar & Belt Swing Assembly

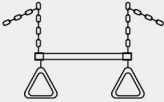



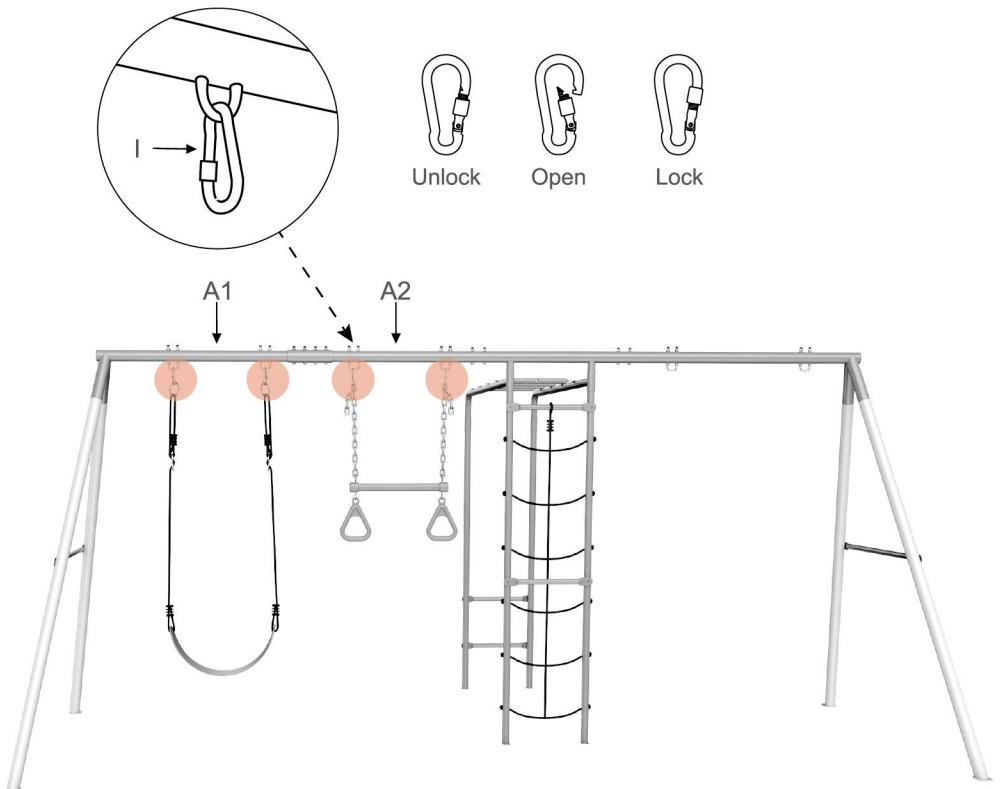

Parts and Tools Required

No.	PICTURE	DESCRIPTION	QTY
D		Trapeze Bar	1
E		Belt Swing with Chain	1
I		Carabiner	4

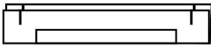

Step 6: Platform Swing Assembly

Parts and Tools Required

No.	PICTURE	DESCRIPTION	QTY
F1		Platform Swing	1
F2		Swing Rope with Eye Bolt	2
F3		U Tube with Foam for Platform Swing	2
F4		Long Tube with Foam for Platform Swing	2
G		Spanner	1
H		Allen Wrench	1
I		Carabiner	2

1. Insert 4 tubes into the swing seat.
2. Connect two joints at the left side of swing, make sure two holes align.
3. Align the pipe ends at the right side of swing, then push down the short tube gently until it is even.

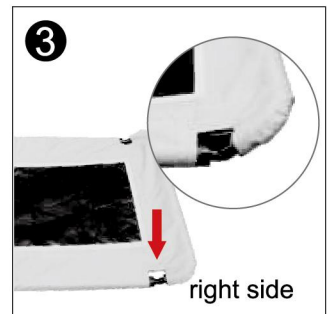
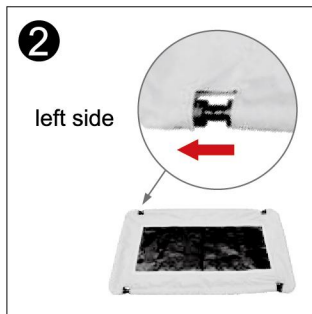
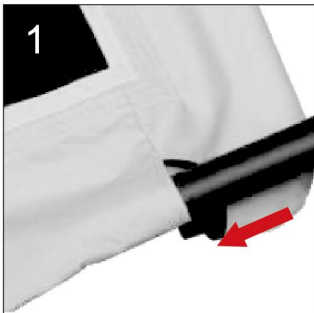

4. Insert the bolt into the hole at the front side swing.

5. Put the washer and nut onto the bolt, and tighten with a spanner until 3-4 threads of bolts are exposed. Please make sure all the screws are tightened for your safety.

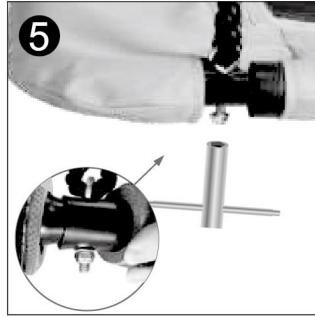

6. Hang the platform swing to the A4 tube.

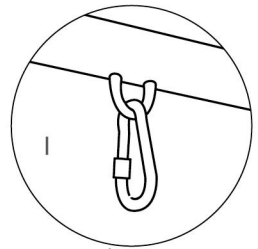



A4



Step 6: Ground Stake Assembly

Parts and Tools Required

No.	PICTURE	DESCRIPTION	QTY
J1		Ground Stake	8
J2		Iron Bar	1

The stake should be fixed firmly to or be buried under the ground.

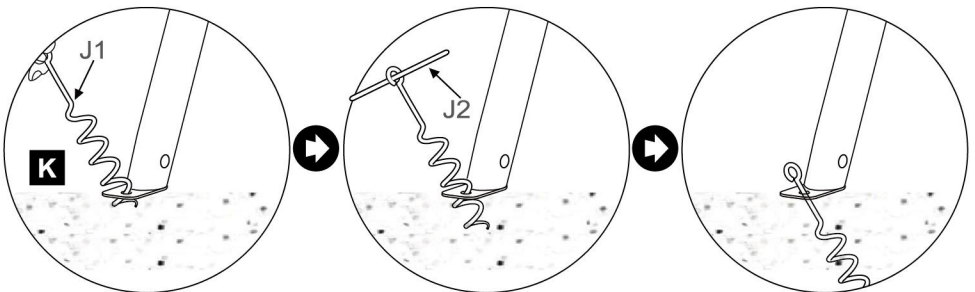
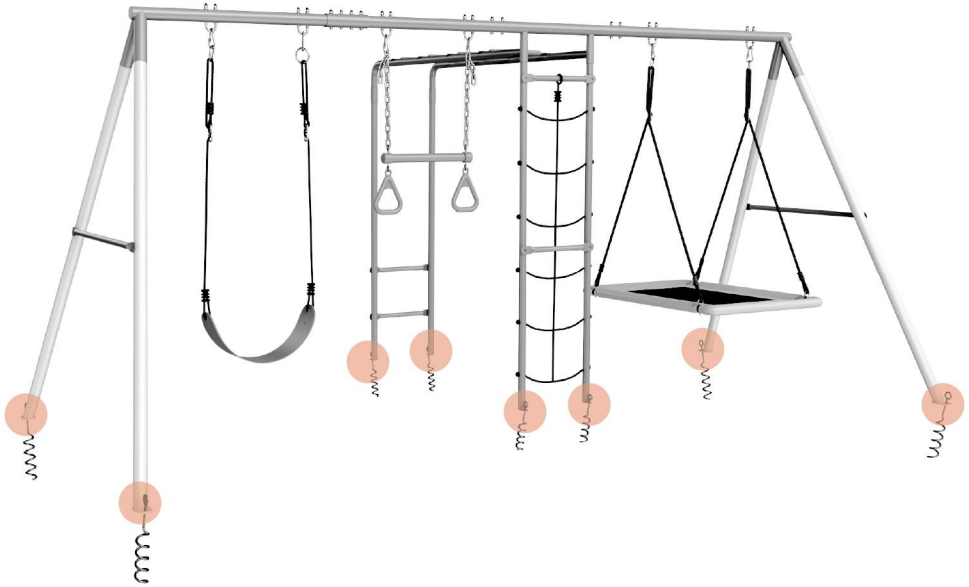

Double Check And Tighten Bolts

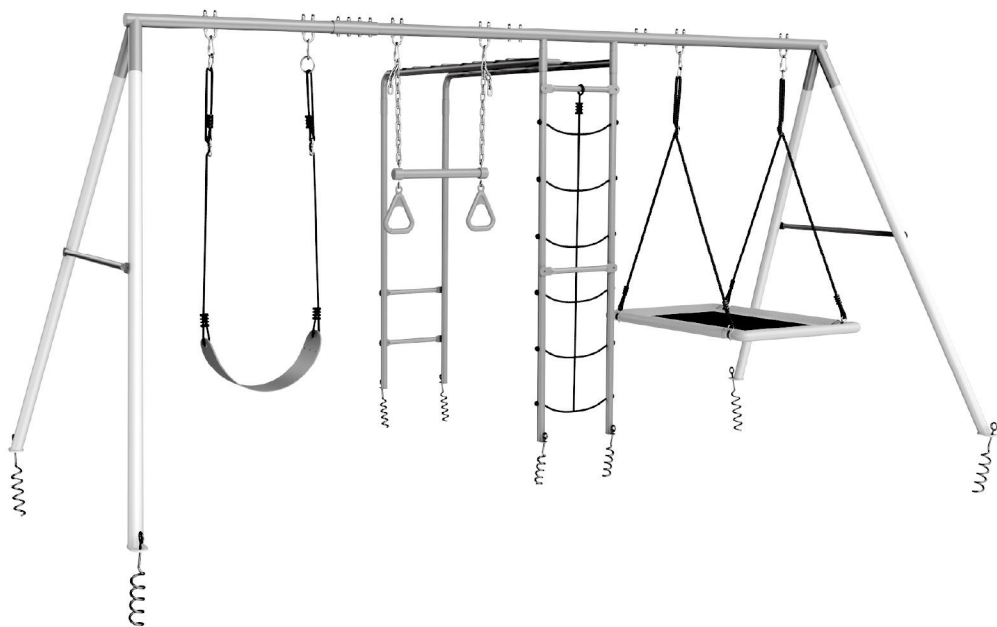

The assembly is complete.

Note: Please double check and tighten all bolts before using the swing set.