

Installation & Assembly

PORCH SWING

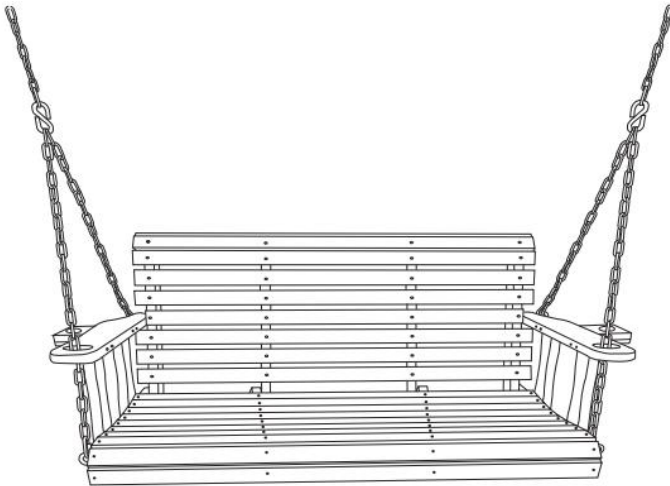

This is the original instruction, please read all manual instructions carefully before operating. We reserve a clear interpretation of our user manual. The appearance of the product shall be subject to the product you received. Please forgive us that we won't inform you again if there are any technology or software updates on our product.

SAFETY INSTRUCTIONS

WARNING:

Read this instructions carefully before using this product. Failure to do so can result in serious injury.

Assembly precautions





1. Assemble only should be according to these instructions. Improper assembly can result in hazards.
2. Wear ANSI-approved safety goggles and heavy-duty work gloves during assembly.
3. Keep the assembly area clean and well-lit.
4. Keep bystanders out of the area during assembly.
5. Do not assemble when tired or when under the influence of alcohol, drugs or medication.
6. The product capabilities apply to properly and completely assembled products only.
7. Assemble on a flat, level, hard and smooth surface capable of safely supporting the porch swing.
8. For additional information regarding the parts listed in the following pages, please refer to the Assembly Diagram of this manual. Unwrap and separate all parts in a clean work area.





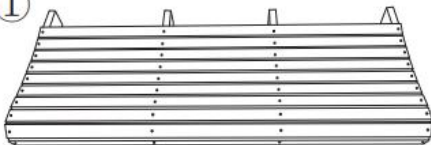

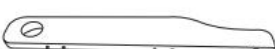

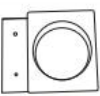

Use precautions

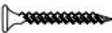
1. Do not exceed weight capacities.
2. Use only on a flat, level and hard surface capable of safely supporting a fully loaded porch swing.
3. Use as intended only.
4. Inspect before every use; do not use if parts are loose or damaged.

SAVE THESE INSTRUCTIONS

PARTS LIST

<p>①</p>  <p>1PCS</p>	<p>②</p>  <p>1PCS</p>
<p>③</p>  <p>1PCS</p>	<p>④</p>  <p>1PCS</p>
<p>⑤</p>  <p>4PCS</p>	<p>⑥</p>  <p>2PCS</p>
<p>⑦</p>  <p>2PCS</p>	

<p>A</p>  <p>12PCS</p>	<p>B</p>  <p>12PCS</p>	<p>C</p>  <p>12PCS</p>	<p>D</p>  <p>8PCS</p>
<p>E</p>  <p>2PCS</p>	<p>F</p>  <p>2PCS</p>	<p>G</p>  <p>8PCS</p>	<p>H</p>  <p>4PCS</p>
<p>I</p>  <p>4PCS</p>	<p>J</p>  <p>1PCS</p>	<p>K</p>  <p>1PCS</p>	<p>L</p>  <p>4PCS</p>

ASSEMBLY STEP

STEP1

Install support plates 5 on seat 1 with parts A, B and C.

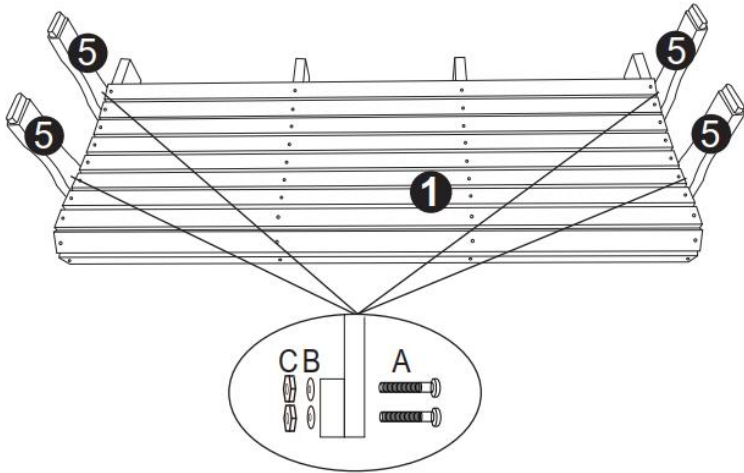

STEP2

Install the left and right handrails 3,4 on the support plate 5 and tighten them with screw D. In order to install a perfect swing, we recommended you to tighten D after completing step3.

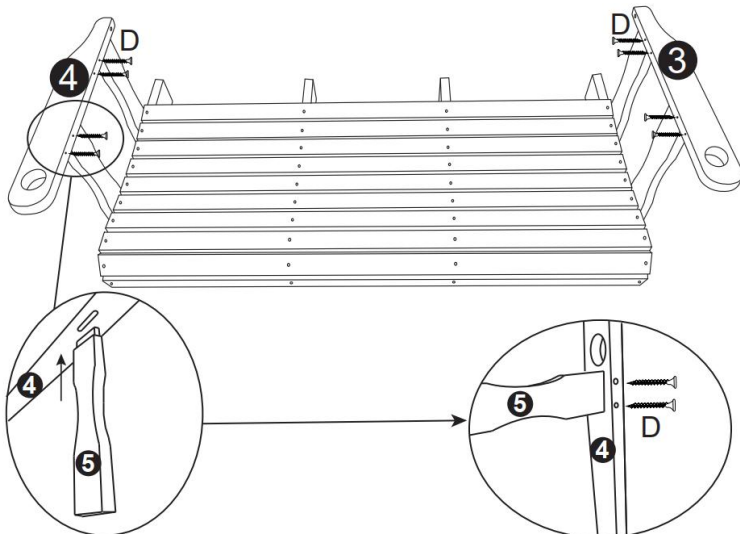

STEP3

Connect the backrest 2 to the seat 1 with parts A, B, and C, install cup brackets 7 to 3 and 4 with L respectively.

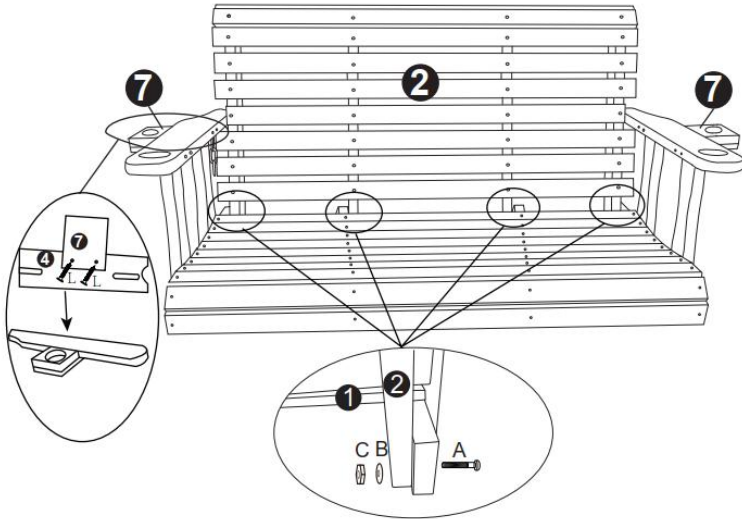

STEP4

Connect armrests 3,4 to backrest 2 with parts F,G,H, and E,G,H to the front hole of the seat noting that the holes of parts E and F facing forward. Then part E and F hang ring I on respectively.

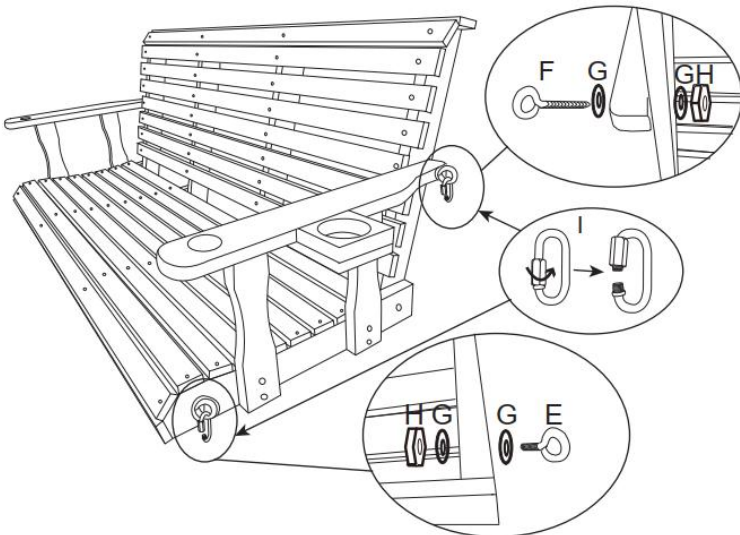

STEP5

Chains 6 is connected to parts E and F through hanging ring I, and part I is tightened according to the figure to complete the installation.

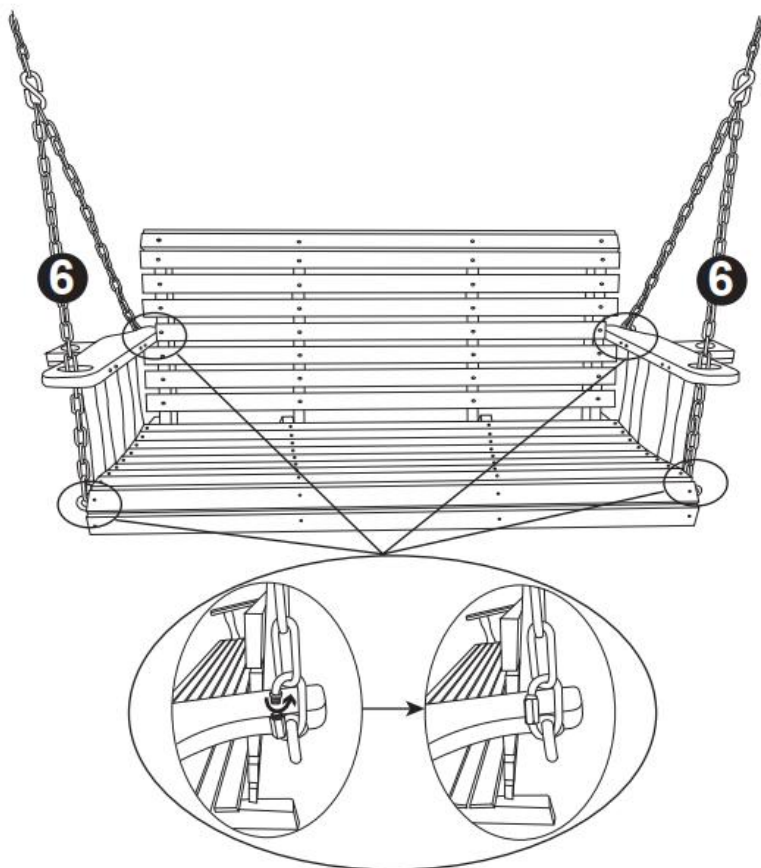

PRODUCT PARAMETER

Specification	65*25.6 inch(seat size)
Size (mm)	1702*710*600
Colour	White
	Brown
Type	5.5ft with saucer
Main material	China fir