



15 : 00

estimated assembly
+installation time



1 or more

people required

Ok, let's
get started!



- Put on mood music!
- To prevent damage to product, use the clean side of package carton or rug as working surface for assembly.
- In the event of missing or damaged parts, delivery problems etc., please reach out to our team. We will be happy to fix the problem!

care guide

- Clean regularly with a soft and dry cloth.
- To protect finish, avoid use of abrasive cleaners.
- Wipe up spills immediately. Please!

ⓘ While assembling the product, tighten the bolts up to 50%. Once all parts are in place, only then fully tighten the bolts.



product
parts



(A)
Shelf
x1

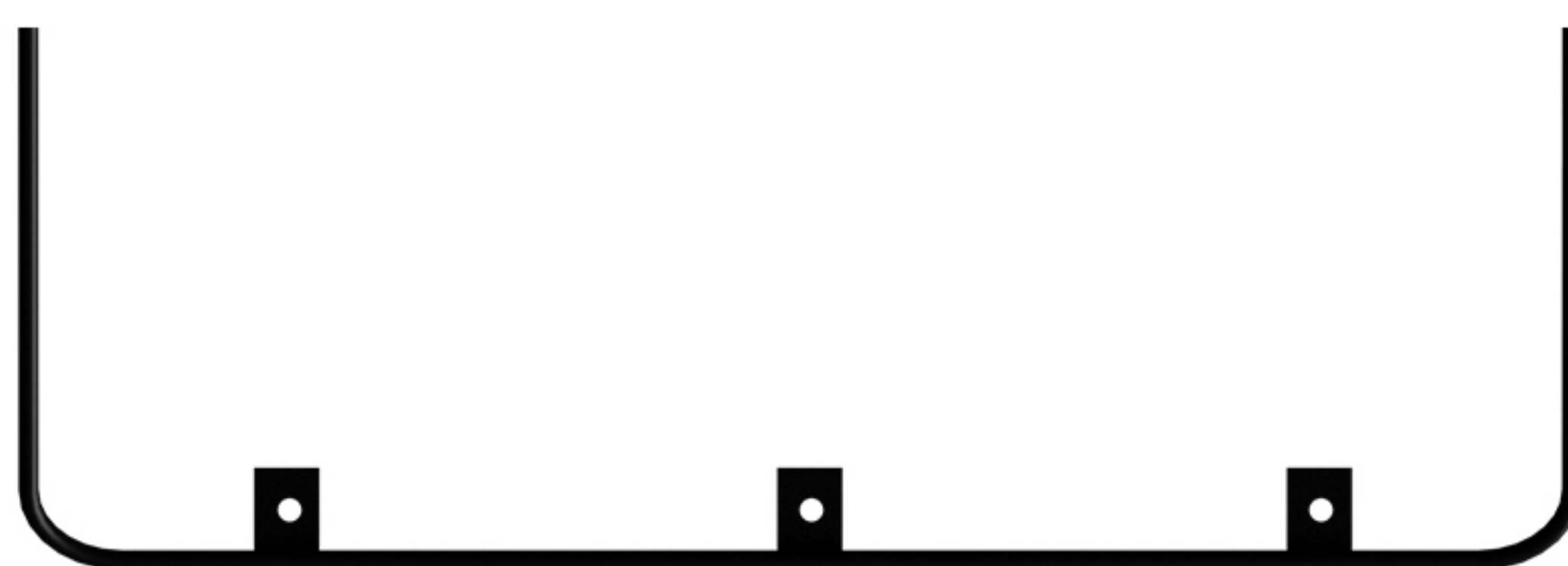

(B)
Metal Rod
x1

what's included

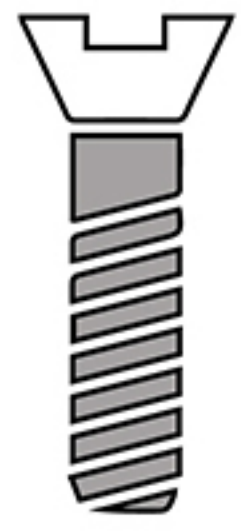

(C)- Bolt
x3

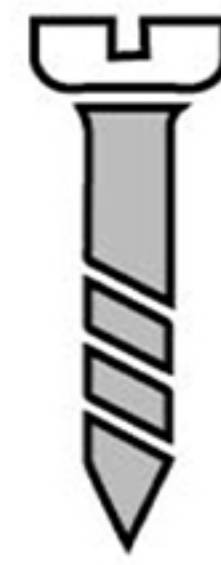

(E)- Screw
x2

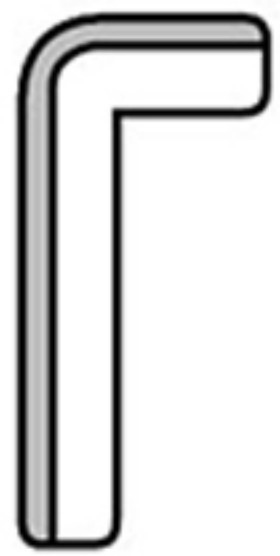

(D)- Allen Key
x1



(F)- Wall Plug
x2

installation instructions

Take a deep breath going in.
This is easy even if you are not
used to tools. Just follow these
steps to the T, and the
outcome will be
worth it!



- ⓘ While assembling the shelf, tighten the bolts on the metal rod (B) only up to 50%. Once the shelf is installed on the wall, only then fully tighten the metal rod.

step 1:

Start by turning shelf (A) upside down and aligning it with metal frame (B) so that the pre-drilled holes on (B) are on top of the pre-drilled holes on (A). See this image for reference.

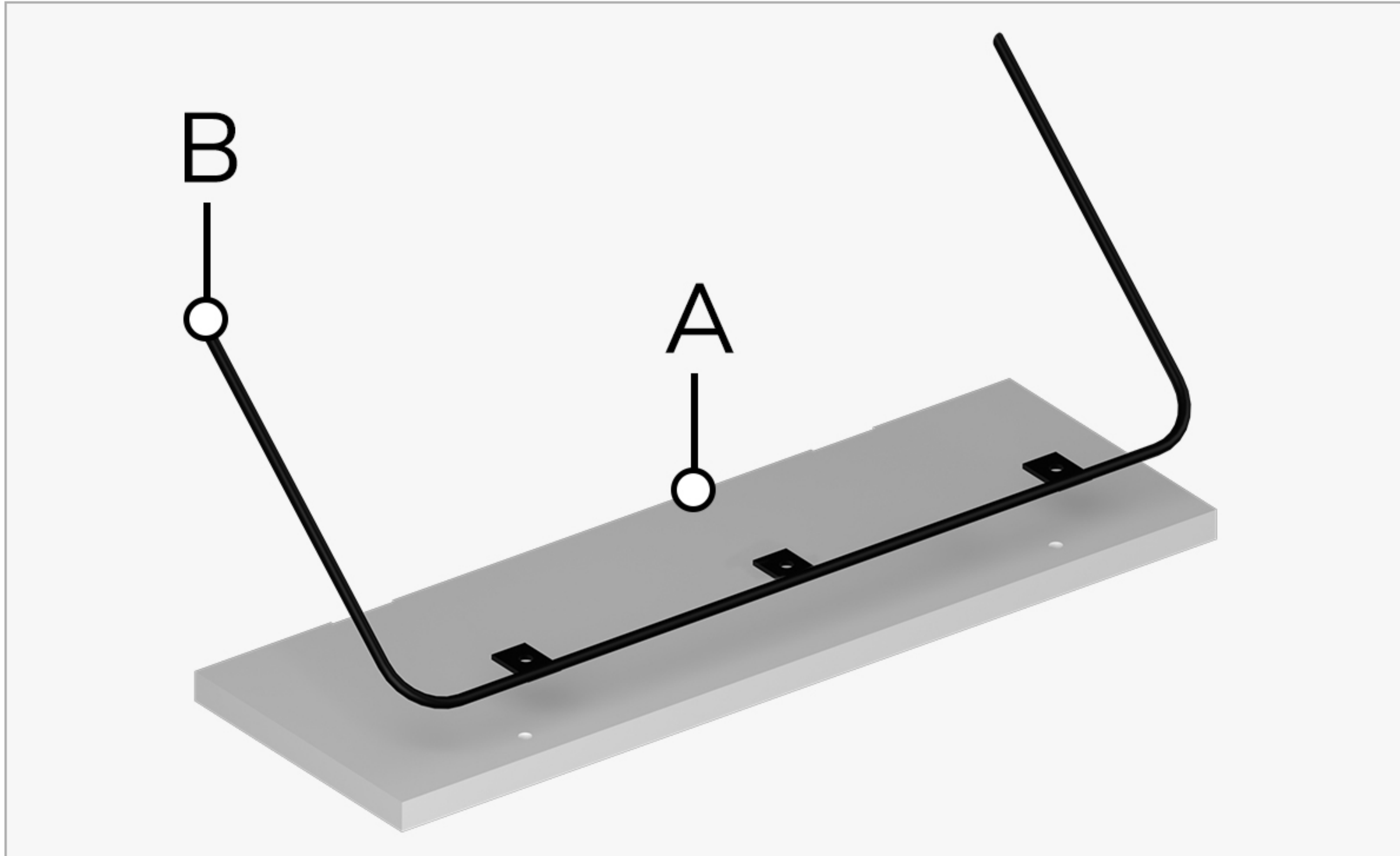

step 2:

Attach metal frame (B) to shelf (A) using bolts (C). Tighten all points using allen-key (D).

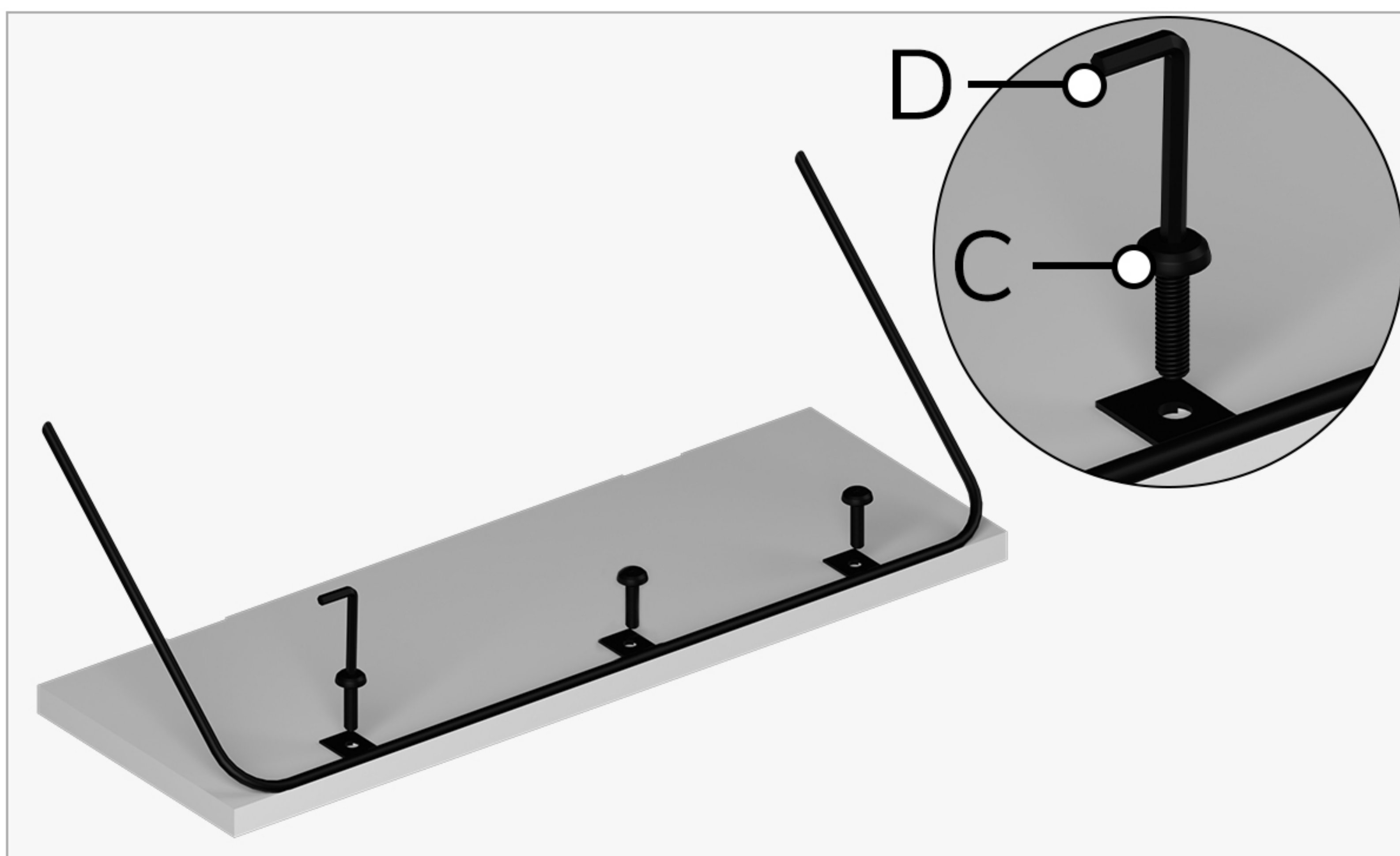

step 3:

Now, place the assembled shelf on the wall where you want to hang it and put a spirit level on it to check alignment. Adjust if needed.

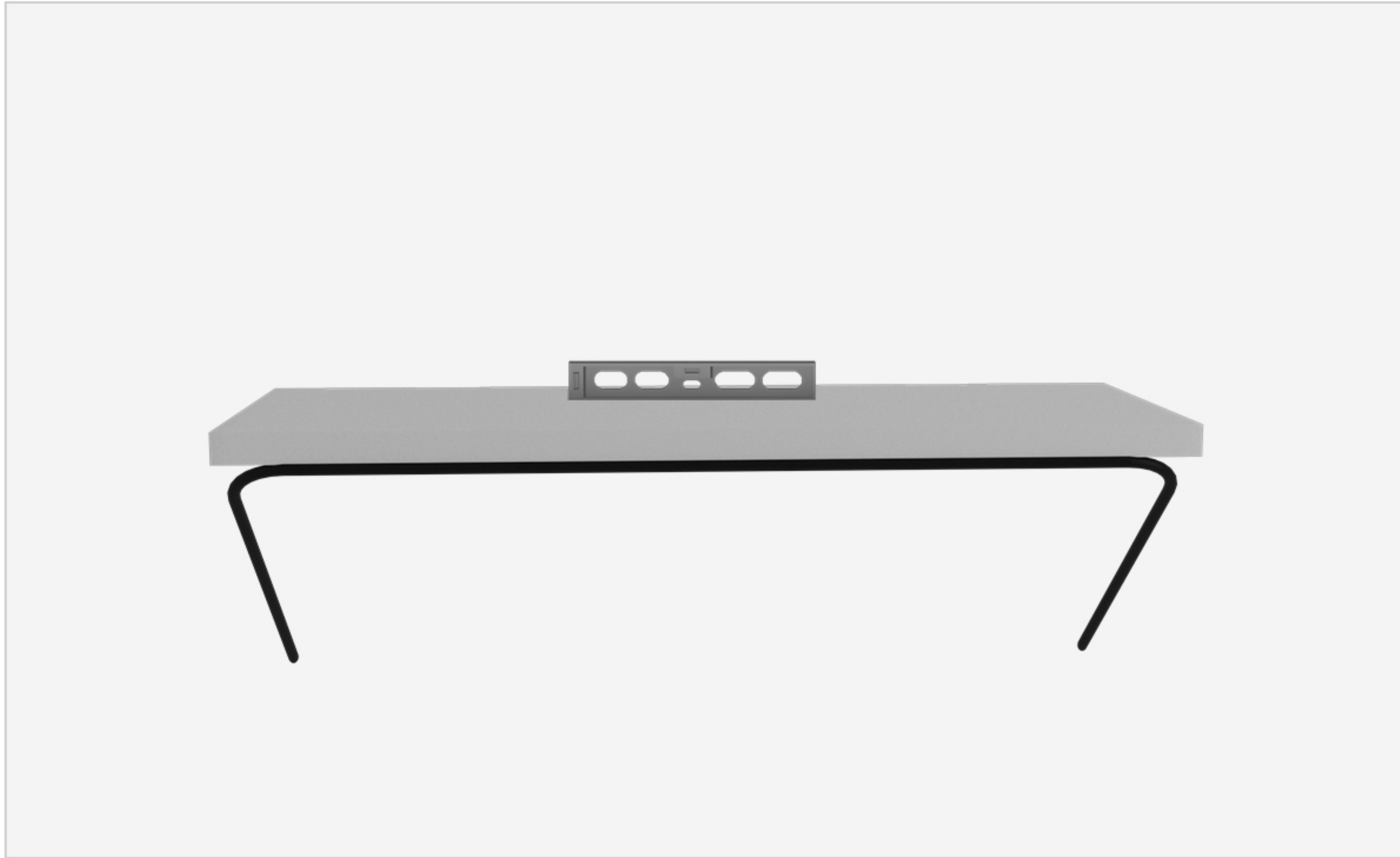

step 4:

Once the shelf is straight aligned to the wall, make a line running from one end to the other using a pencil.

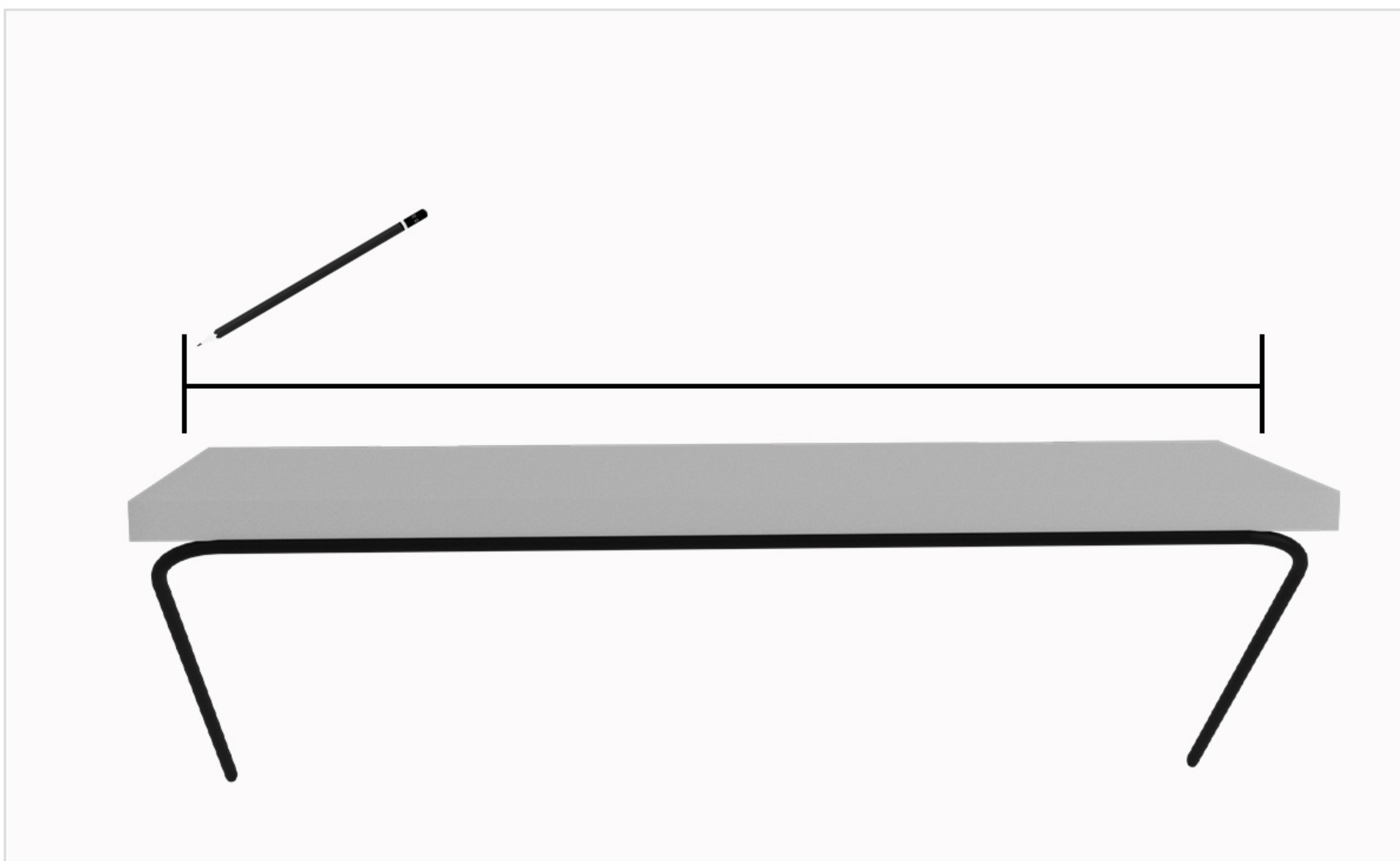

step 5:

Next, measure the distance between the two keyholes using a measuring tool.

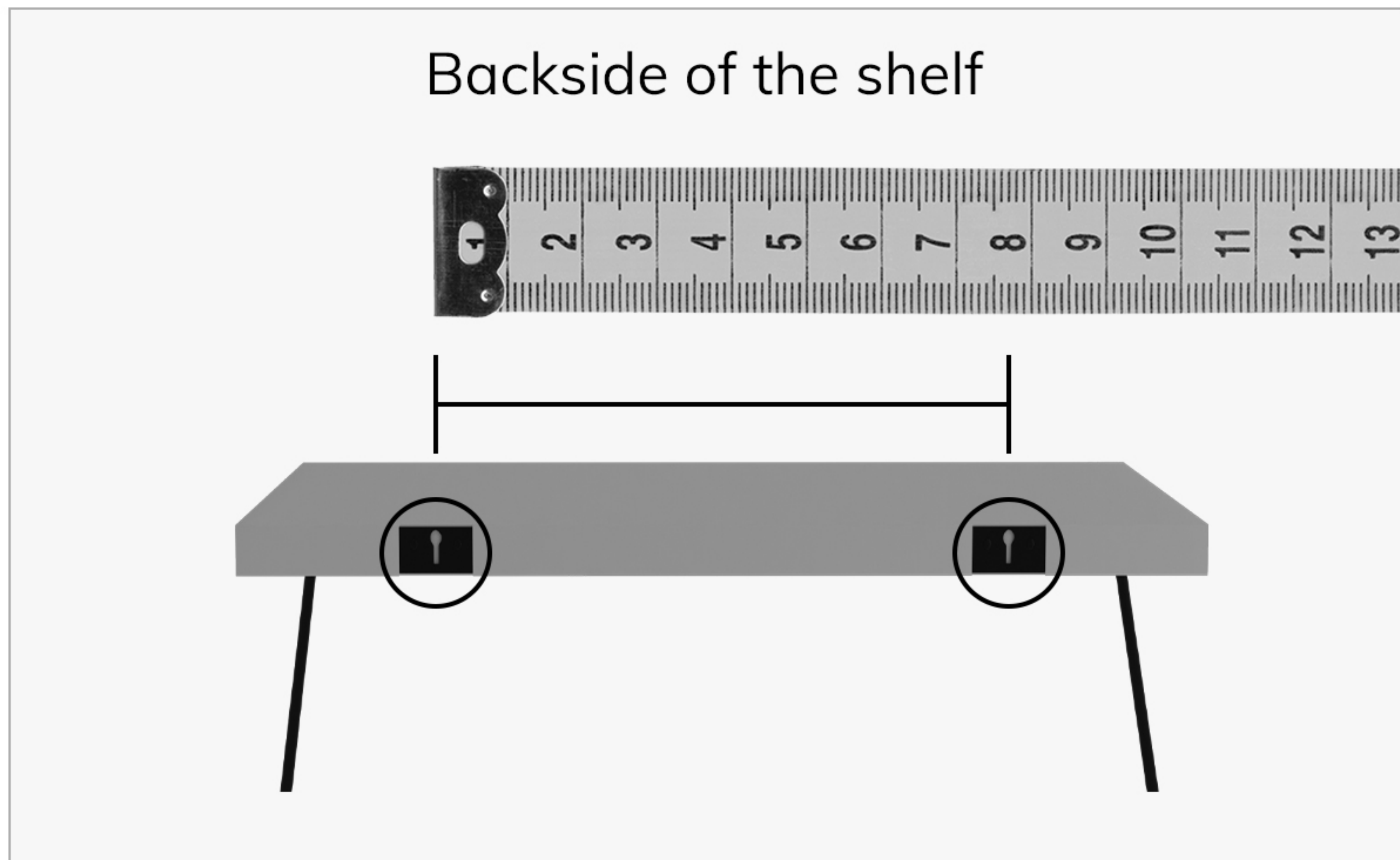

step 6:

Place the measuring tool against the parallel line on the wall and make two marks on it taking this image as reference.

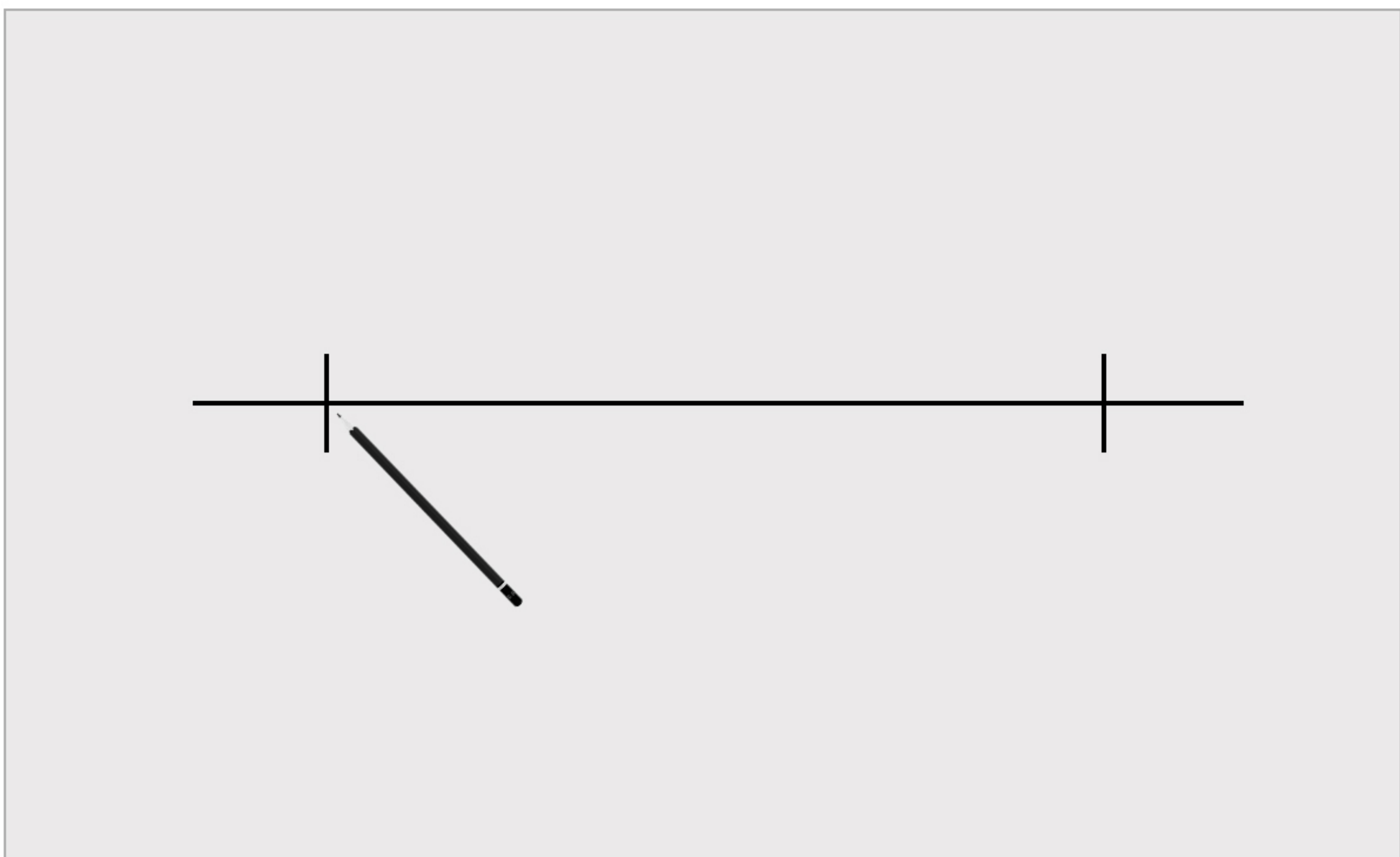

step 7:

Drill holes approx. 10 mm at the points you just marked



step 8:

Insert the wall plug (F) and tighten with the help of a screwdriver.

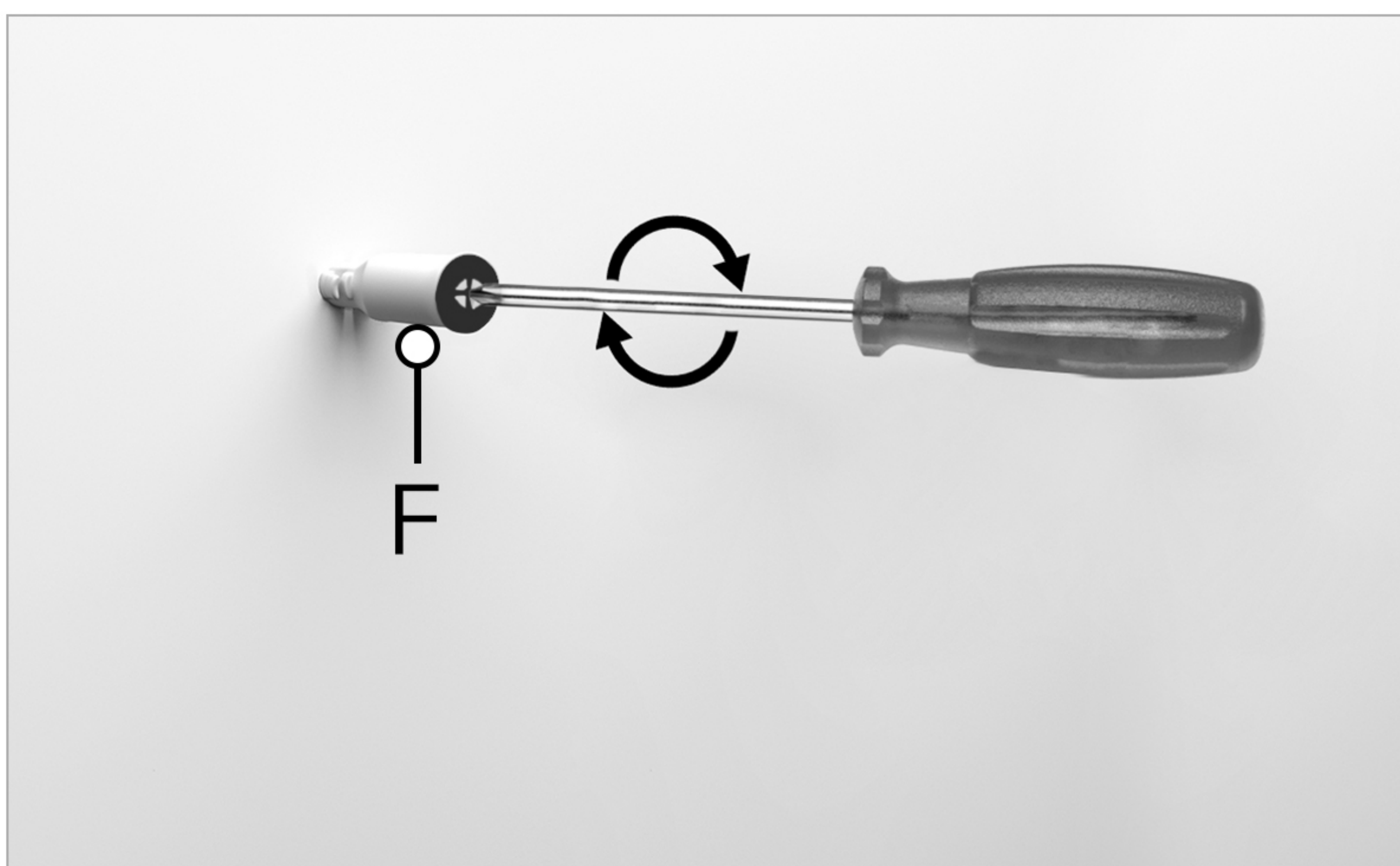

step 9:

Then, insert the screws (E) using a screwdriver.

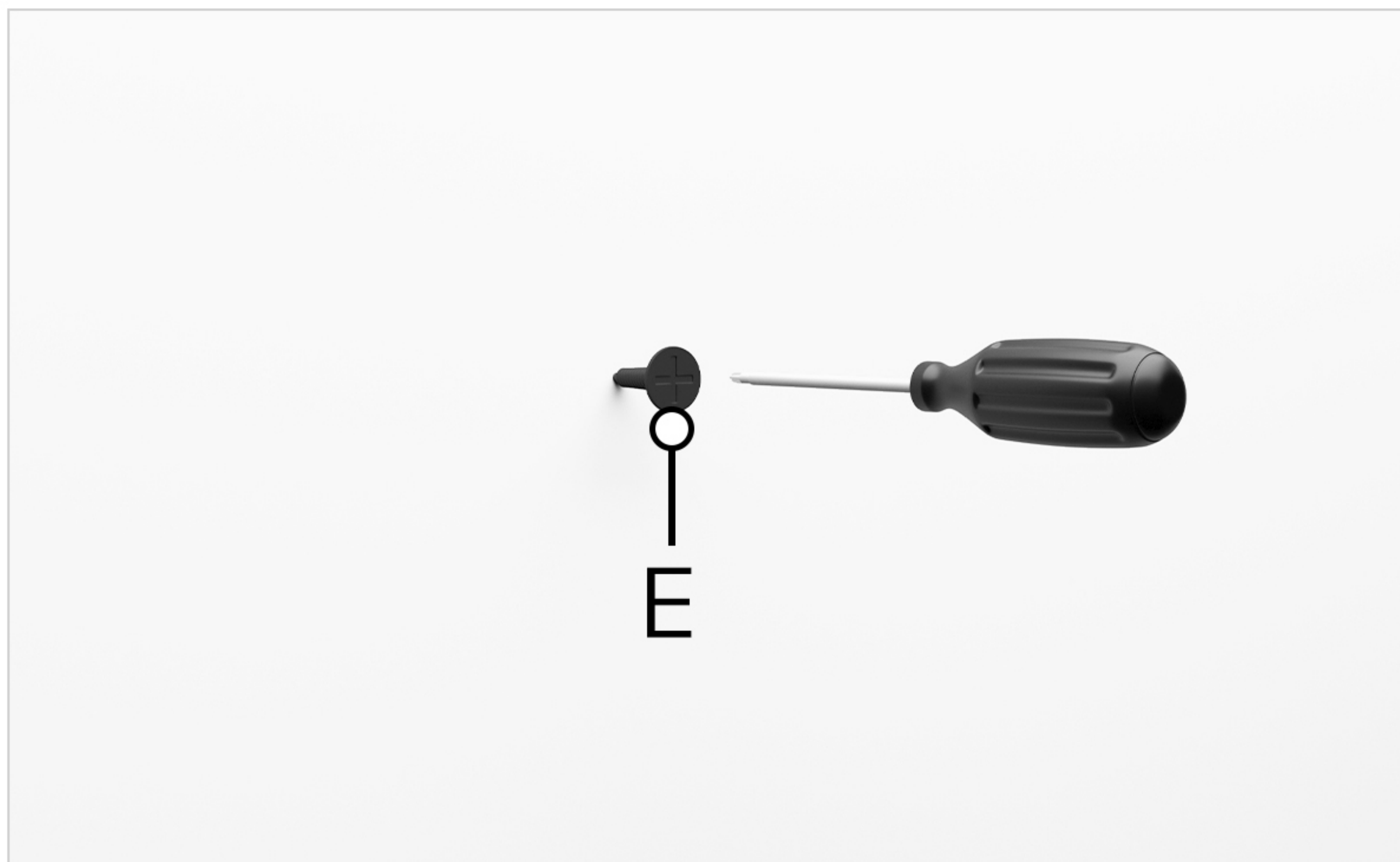

step 10:

Place the keyhole slots over the screws.

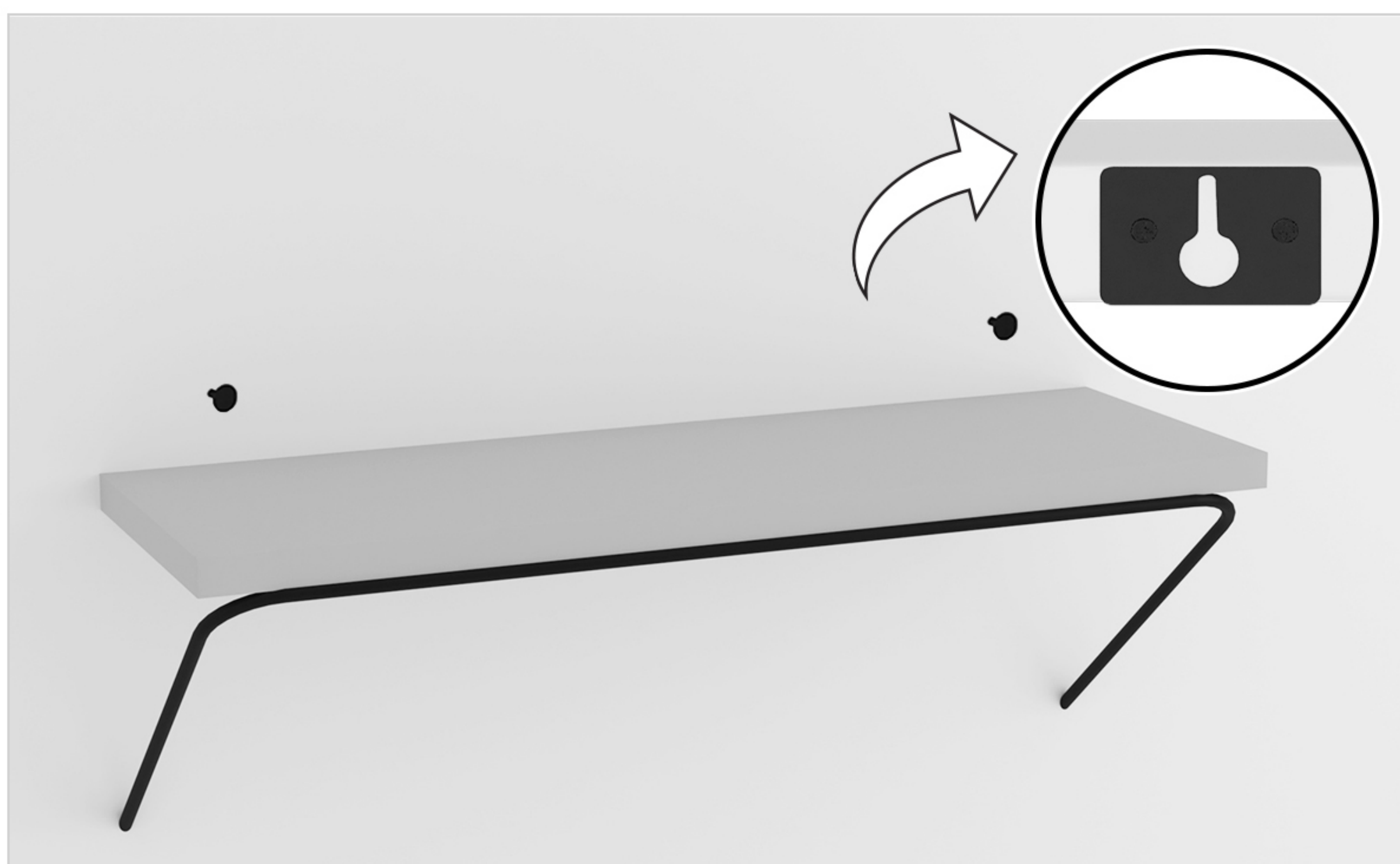

Voila! Your shelf is now installed and secure!

you've
got
a home
with us

