

# User's Manual

## Bed Frame



### Note:

1. Should be assembled on flat ground to keep balance.
2. Before completing the installation, do not tighten the screws.
3. Please contact **after-service** directly for any breakage problem of the product, we will provide you with satisfactory service.

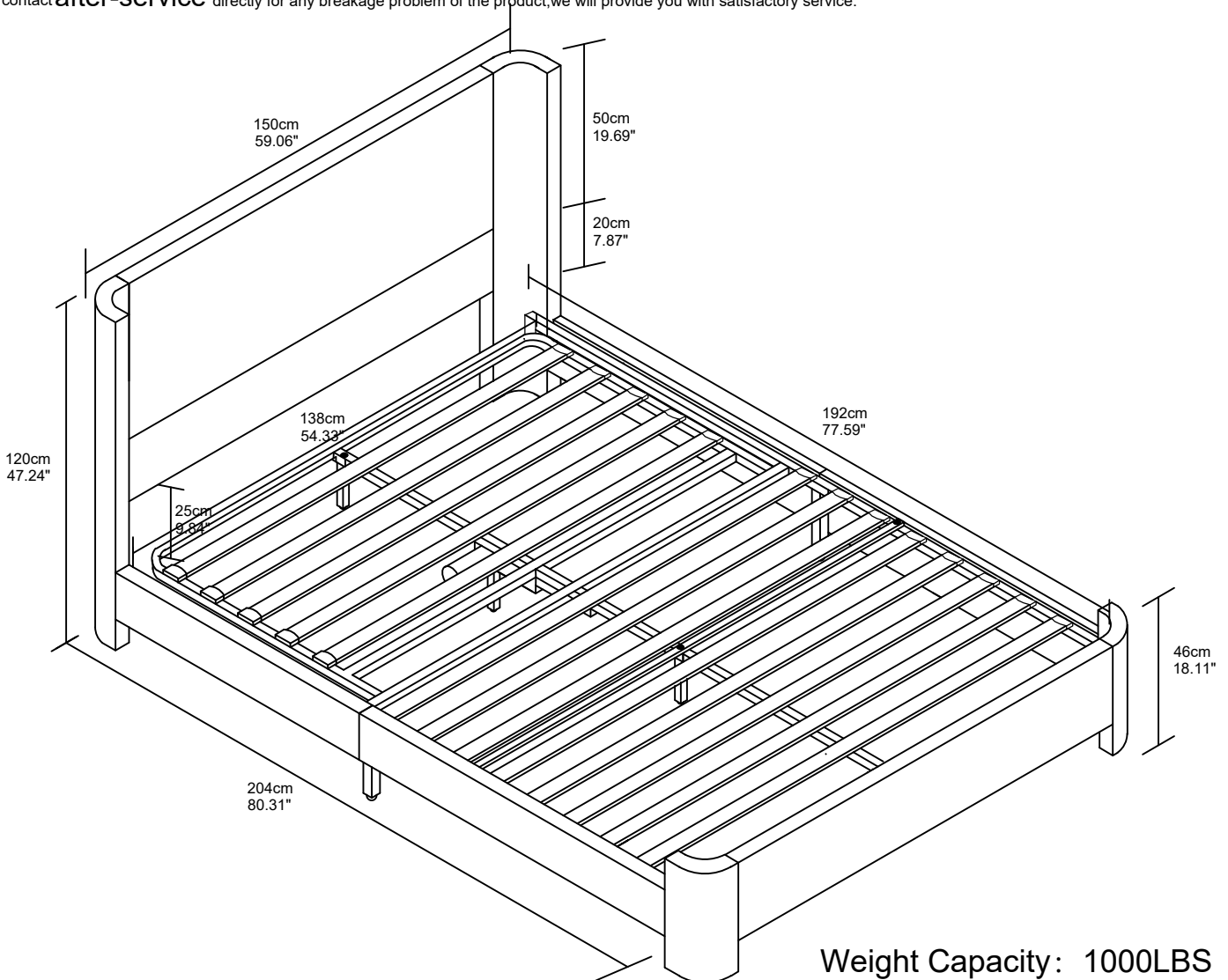

Before starting the assembly, you must read the whole manual and follow the instructions



It needs at least two people to install.

**601F-**  
W601FYW/ W601FYB / W601FMD

V1.0

## Thank You for Choosing Our Furniture!

### Return & Support Instructions

**DO NOT RETURN TO THE STORE!** Contact us directly for quicker assistance.

- **Missing or Damaged Parts:** Occasionally, warehouse handling or shipping may not be as careful as we'd like. If any parts are missing or damaged, **we'll send replacements at no extra cost.**
- **Quality Concerns or Defects:** If the product doesn't meet your expectations or has any defects, you can reach out to us directly through the platform or via email at [SibedsAfterService@outlook.com](mailto:SibedsAfterService@outlook.com) with your order details and a description of the issue. No matter how you contact us, **we'll respond within 24 hours to assist you.**

### Before You Start Assembly

1. **Read the Instructions Thoroughly:** Make sure to review the entire manual from start to finish before beginning.
2. **Have Assistance Ready:** Depending on the product size, two or more adults may be needed for safe and efficient assembly.
3. **Keep Packaging:** Retain all packaging materials until the assembly is complete and you've confirmed that all parts are intact.  
*Note: Please ensure your hands are clean when opening the internal packaging. If you encounter any stains that can't be cleaned, don't worry—contact us for assistance.*
4. **Assembly Tools:** Our package includes convenient assembly tools, so there's no need to purchase anything extra. However, if you have your own preferred tools at home, feel free to use them.

### Safety Precautions During Assembly

- **Stable Surface:** Ensure that the product is placed on a flat, stable surface during assembly to avoid accidents or damage to the product.
- **Keep Sharp Objects and Small Parts Away from Children:** Please keep sharp tools and small components out of reach of children to prevent any accidents.

### Assembly Guidelines

If you experience any difficulties during assembly that prevent you from continuing:

- **Safely Store All Parts:** Ensure all components are stored in a secure place to avoid loss.
- **Contact Us for Help:** Reach out to us immediately, and we'll provide the support you need to resolve the issue.

**Important:** Some key parts may be stored in hidden compartments within the product, such as **inside the headboard.** Please inspect these areas carefully to ensure no parts are overlooked.

### Screw Installation Instructions

To ensure proper alignment and stability:

1. **Start by Hand-Tightening:** Insert each screw halfway into its designated hole by hand. Avoid fully tightening them at this stage.
2. **Check Alignment:** Once all screws are partially inserted, confirm that the structure is aligned and level.
3. **Secure Screws:** After ensuring proper alignment, fully tighten each screw to securely fasten the product.

**We are committed to ensuring your assembly process is as smooth as possible. If you have any questions or need further assistance, please don't hesitate to contact us!**

## Instrucciones para devoluciones y soporte

### ¡ NO DEVUELVA EL PRODUCTO A LA TIENDA!

Contáctenos directamente para obtener asistencia más rápida.

- **Piezas faltantes o dañadas:** En ocasiones, el manejo en el almacén o el envío pueden no ser tan cuidadosos como nos gustaría. **Si faltan piezas o están dañadas, le enviaremos reemplazos sin costo adicional.**
- **Problemas de calidad o defectos:** Si el producto no cumple con sus expectativas o tiene algún defecto, puede comunicarse con nosotros directamente a través de la plataforma o por correo electrónico a **SibedsAfterService@outlook.com** con los detalles de su pedido y una descripción del problema. **Sin importar cómo nos contacte, responderemos dentro de las 24 horas para asistirle.**

### Antes de comenzar el ensamblaje

1. **Lea detenidamente las instrucciones:** Asegúrese de revisar todo el manual de principio a fin antes de comenzar.
2. **Tenga ayuda disponible:** Dependiendo del tamaño del producto, se podrían necesitar dos o más adultos para un ensamblaje seguro y eficiente.
3. **Conserve el embalaje:** Guarde todos los materiales de embalaje hasta que el ensamblaje esté completo y haya confirmado que todas las piezas están intactas.  
**Nota:** Asegúrese de que sus manos estén limpias al abrir el embalaje interno. Si encuentra alguna mancha que no pueda limpiar, no se preocupe; contáctenos para obtener ayuda.
4. **Herramientas de ensamblaje:** Nuestro paquete incluye herramientas convenientes para el ensamblaje, por lo que no necesitará comprar nada extra. Sin embargo, si tiene sus propias herramientas preferidas en casa, puede utilizarlas.

### Precauciones de seguridad durante el ensamblaje

- **Superficie estable:** Asegúrese de que el producto esté colocado sobre una superficie plana y estable durante el ensamblaje para evitar accidentes o daños al producto.
- **Mantenga los objetos afilados y las piezas pequeñas fuera del alcance de los niños:** Por favor, mantenga las herramientas afiladas y los componentes pequeños fuera del alcance de los niños para prevenir accidentes.

### Guía para el ensamblaje



- **Almacene todas las piezas de manera segura:** Asegúrese de que todos los componentes estén guardados en un lugar seguro para evitar pérdidas.
- **Contáctenos para obtener ayuda:** Comuníquese con nosotros de inmediato y le brindaremos el soporte necesario para resolver el problema.  
**Importante:** Algunas piezas clave pueden estar guardadas en compartimentos ocultos dentro del producto, como dentro del cabecero. **Inspeccione cuidadosamente estas áreas para asegurarse de no pasar por alto ningún componente.**

### Instrucciones para la instalación de tornillos



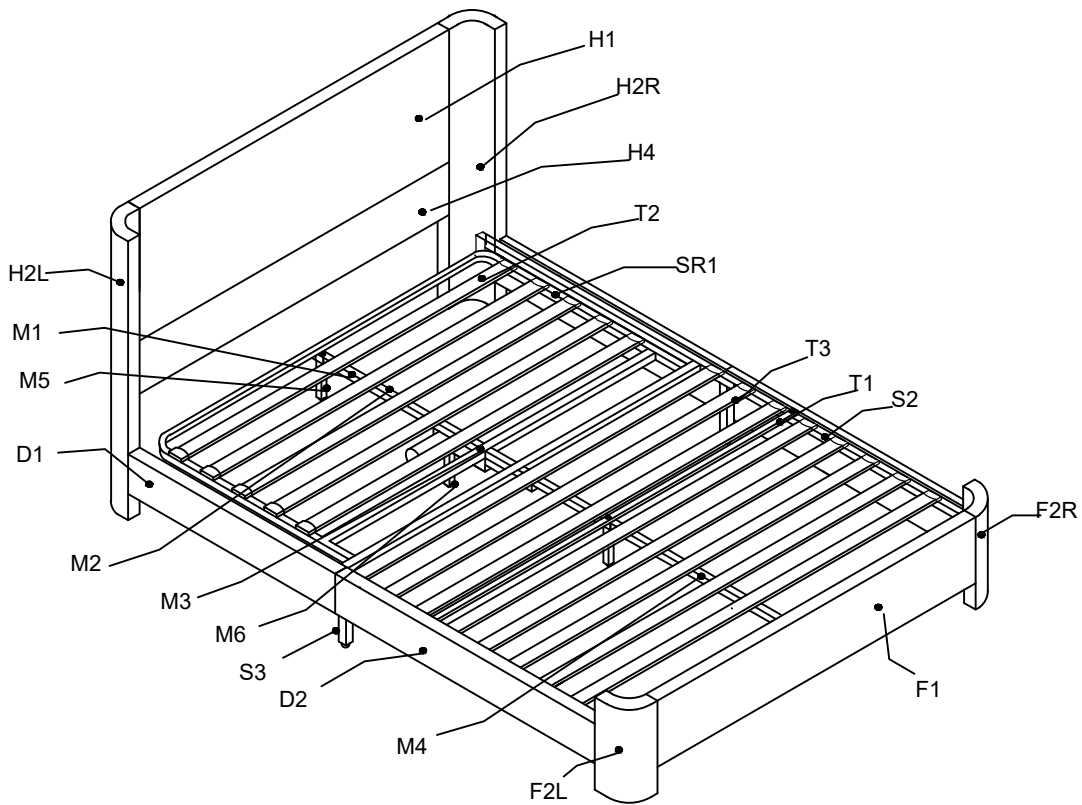

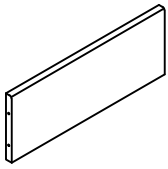
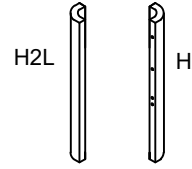
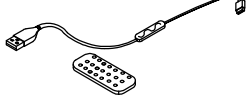
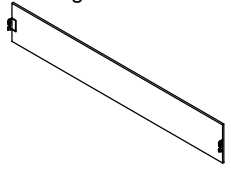
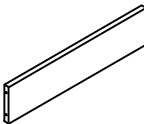
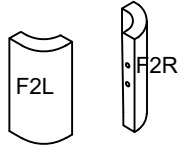
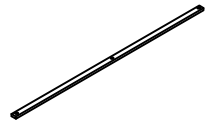
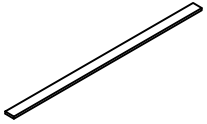
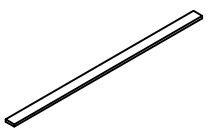

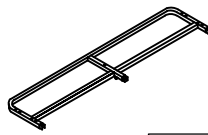
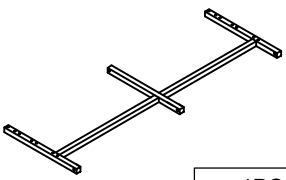
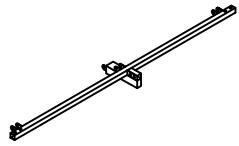
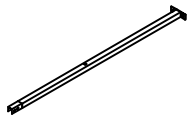
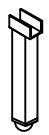
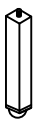



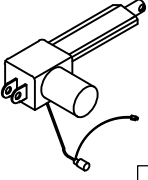
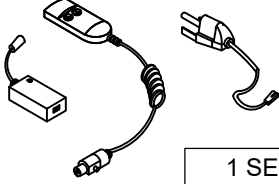
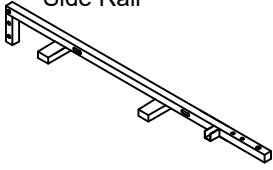
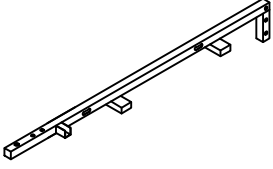
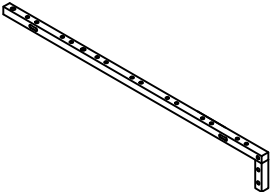
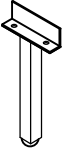
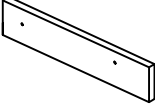
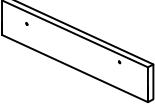

- **Comience ajustando a mano:** Inserte cada tornillo hasta la mitad en su orificio designado a mano. Evite apretarlos completamente en esta etapa.
- **Verifique la alineación:** Una vez que todos los tornillos estén parcialmente insertados, confirme que la estructura esté alineada y nivelada.
- **Ajuste los tornillos:** Después de asegurar la alineación adecuada, apriete completamente cada tornillo para fijar el producto de manera segura.

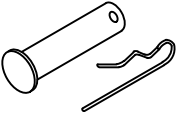
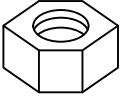
# Assembly Instruction of (Bed)

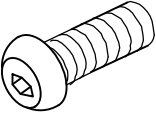

<p><b>H1</b> Headboard</p>  <p>1PC</p>	<p><b>H2L&amp;H2R</b> Wingback</p>  <p>2PCS</p>	<p><b>H3</b> Connecting cable and LED remote control</p>  <p>1 SET</p>	<p><b>H4</b> Light Board</p>  <p>1PC</p>
<p><b>F1</b> Footboard</p>  <p>1PC</p>	<p><b>F2L&amp;F2R</b> FB Feet</p>  <p>2PCS</p>	<p><b>T1</b> Cross Beam</p>  <p>1PC</p>	<p><b>T2</b> Slat</p>  <p>5PCS</p>
<p><b>T3</b> Slat</p>  <p>8PCS</p>	<p><b>T4</b> Slat Anchor Clip</p>  <p>26+2PCS</p>	<p><b>M1</b> Front Of The Metal Bed Head</p>  <p>1PC</p>	<p><b>M2</b> Middle Of The Bed Frame Head</p>  <p>1PC</p>
<p><b>M3</b> Back Of The Bed Frame</p>  <p>1PC</p>	<p><b>M4</b> Foot Middle Rail</p>  <p>1PC</p>	<p><b>M5</b> Middle Leg</p>  <p>2PCS</p>	<p><b>M6</b> Central Middle Leg</p>  <p>1PC</p>



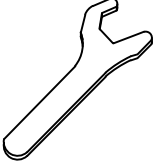

## Assembly Instruction of (Bed)

<p>M7 Electric Motor</p>  <p style="text-align: right;">1PC</p>	<p>M8 Plug Cable And Remote</p>  <p style="text-align: right;">1 SET</p>	<p>SR1 Side Rail</p>  <p style="text-align: right;">1PC</p>	<p>SL1 Side Rail</p>  <p style="text-align: right;">1PC</p>
<p>S2 Side Rail</p>  <p style="text-align: right;">2PCS</p>	<p>S3 Side Rail Feet</p>  <p style="text-align: right;">2PCS</p>	<p>D1 Side Rail</p>  <p style="text-align: right;">2PCS</p>	<p>D2 Side Rail</p>  <p style="text-align: right;">2PCS</p>
<p>U1 M8×60mm Screw with Washer</p>  <p style="text-align: right;">16+2PCS</p>	<p>U2 M8×50mm Screw with Washer</p>  <p style="text-align: right;">21+2PCS</p>	<p>U3 M8×30mm Screw with Washer</p>  <p style="text-align: right;">6PCS</p>	<p>U4 M6×50mm Screw with Washer</p>  <p style="text-align: right;">8+1PCS</p>
<p>U5</p>  <p style="text-align: right;">2SET</p>	<p>UN M8 Nut</p>  <p style="text-align: right;">15+2PCS</p>	<p>U8L M8 L-Wrench</p>  <p style="text-align: right;">1PC</p>	<p>U6L M6 L-Wrench</p>  <p style="text-align: right;">1PC</p>
<p>UO M8 Open-End Wrench</p>  <p style="text-align: right;">1PC</p>	<p>E1 M10×60mm Screw with Washer</p>  <p style="text-align: right;">3PCS</p>	<p>EN M10 Nut</p>  <p style="text-align: right;">3PCS</p>	<p>E3 Plastic Washer</p>  <p style="text-align: right;">16+2PCS</p>
<p>E10L M10 L-Wrench</p>  <p style="text-align: right;">1PC</p>	<p>EO M10 Open-End Wrench</p>  <p style="text-align: right;">1PC</p>		

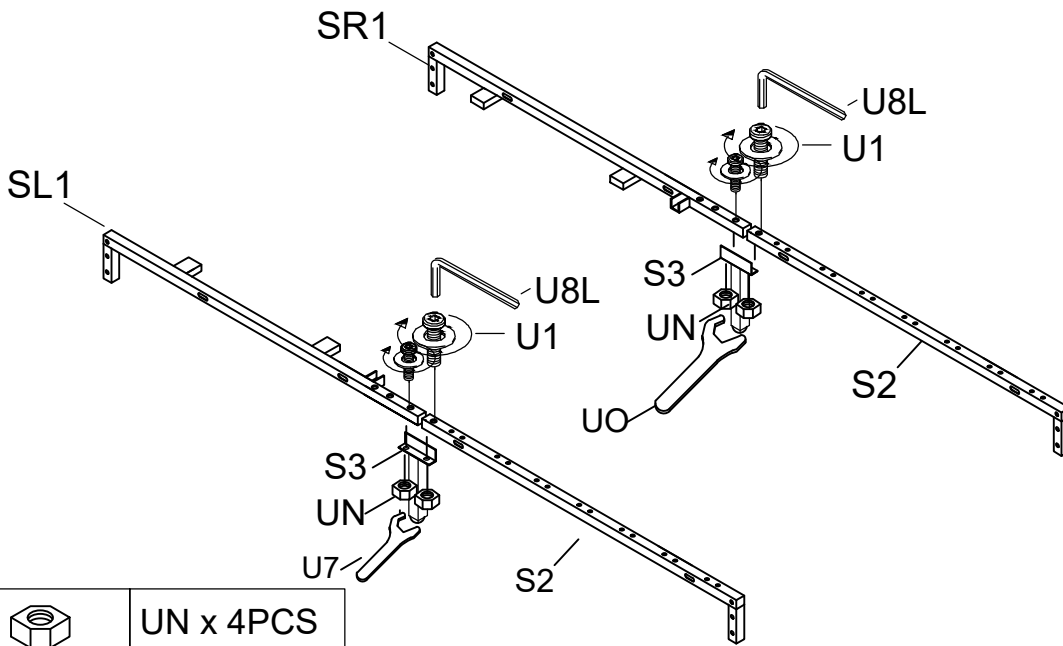
# Assembly Instruction of (Bed)

## STEP 1









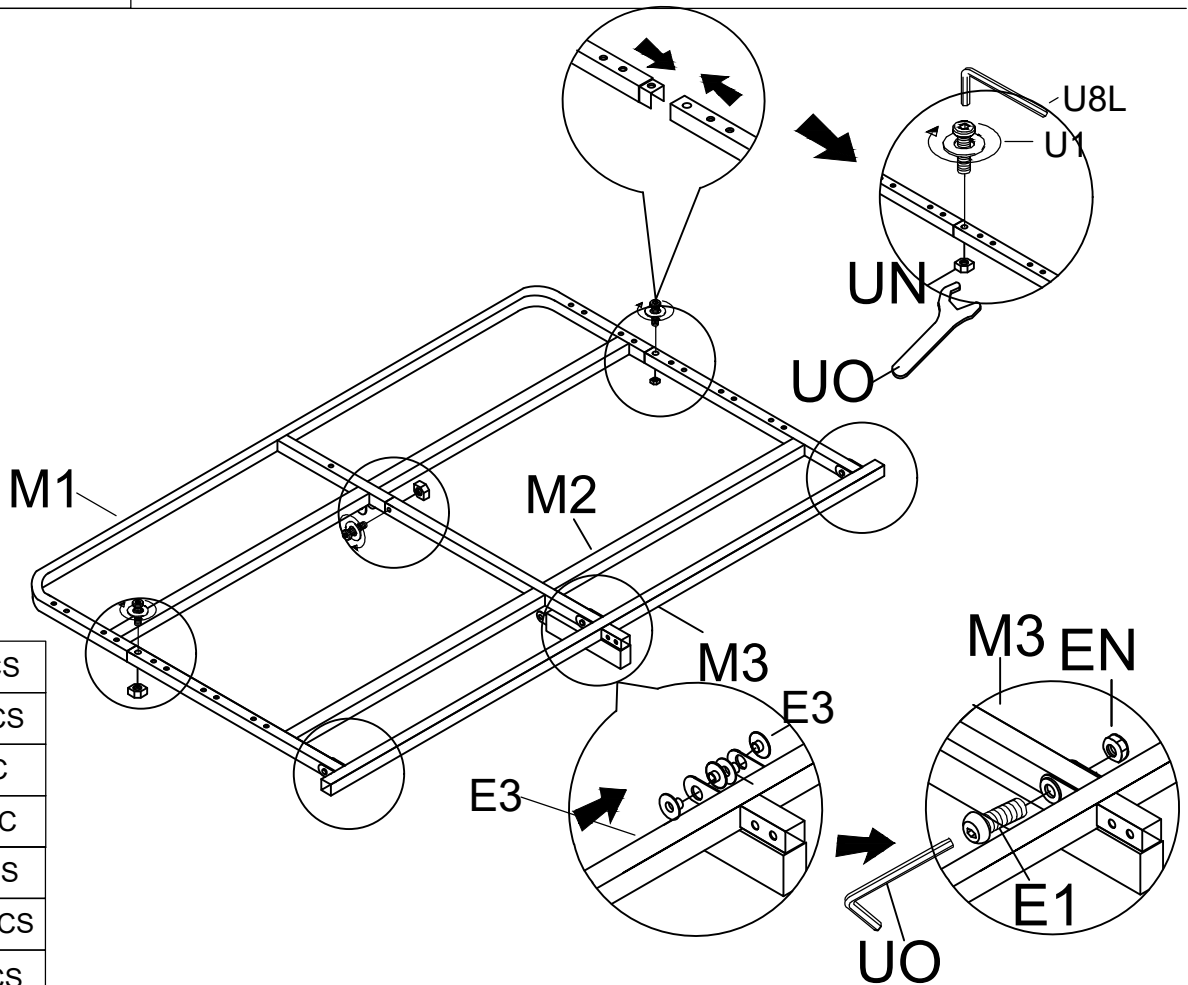

	UN x 4PCS
	U1 x 4PCS
	UO x 1PC
	U8L x 1PC

Screws with washers will make the bed more stable.

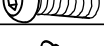
## STEP 2



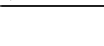

	U1 x 3PCS
	UN x 3PCS
	UO x 1PC
	U8L x 1PC
	E1 x 3PCS
	E3 x 12PCS
	EN x 3PCS
	EO x 1PC
	E10L x 1PC

Screws with washers will make the bed more stable.

# Assembly Instruction of (Bed)

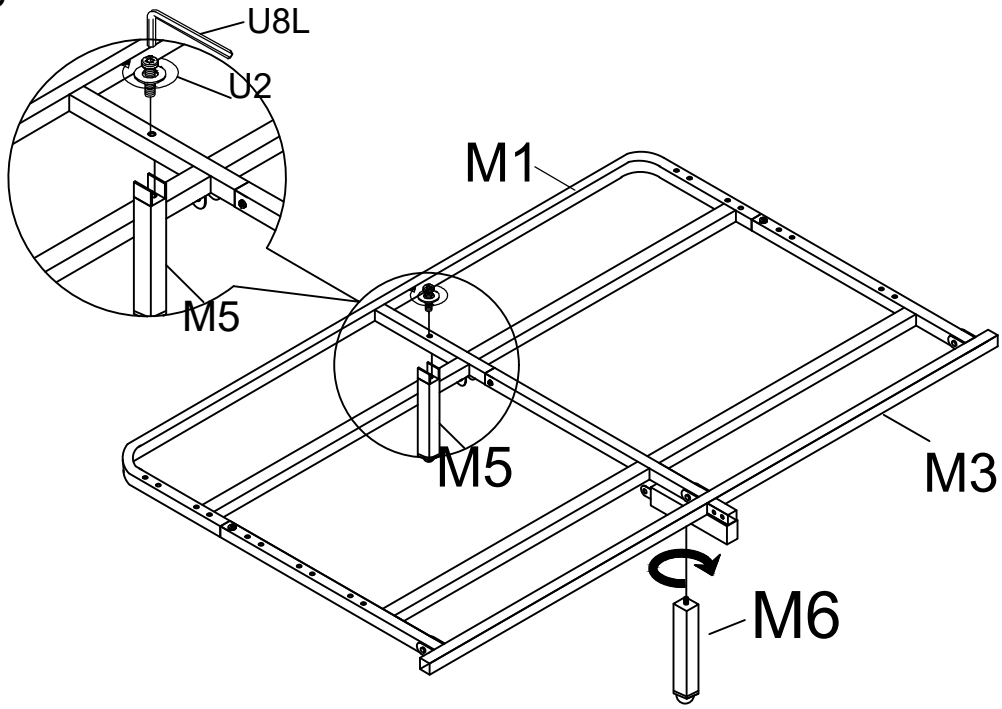
## STEP 3





	U2 x 1PC
	U8L x 1PC

Screws with washers will make the bed more stable.

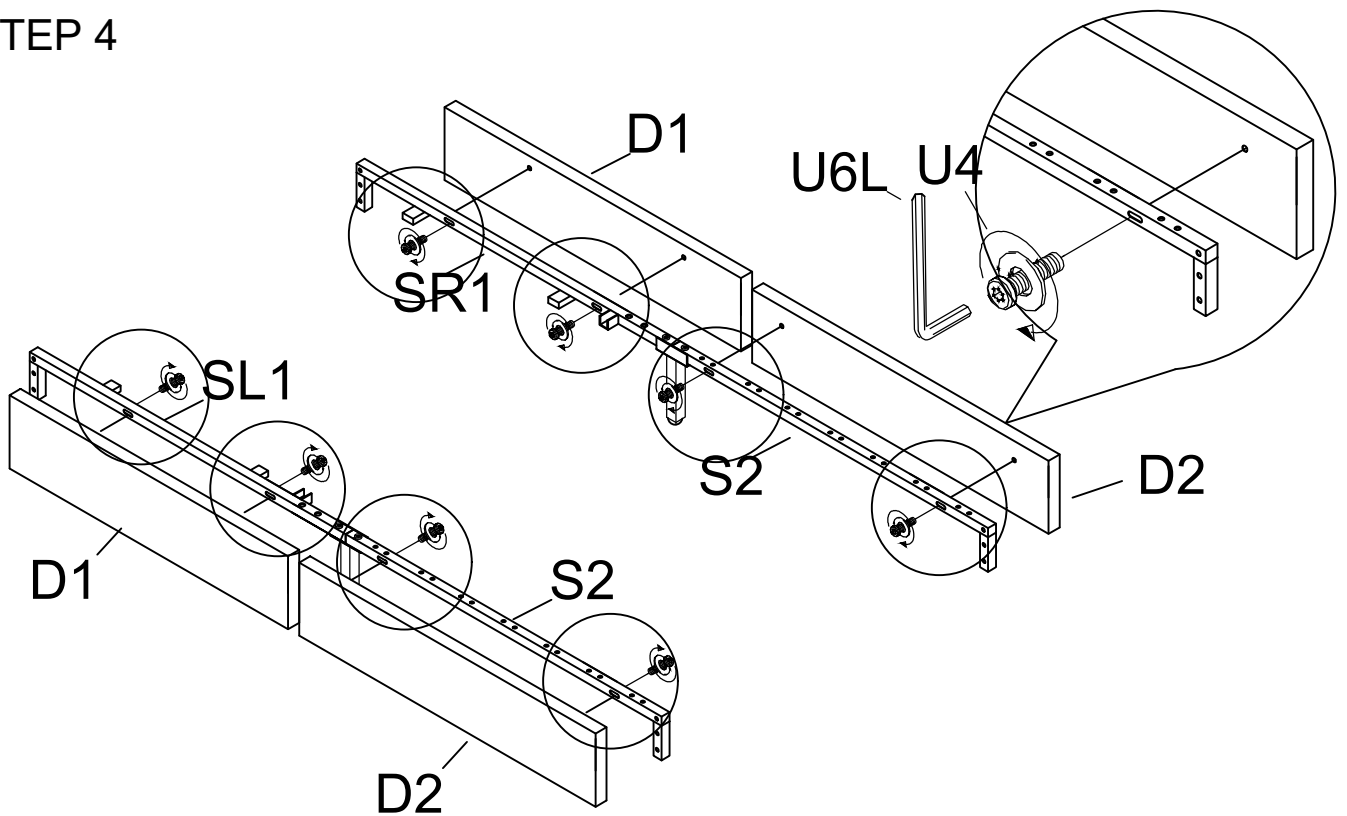
## STEP 4



	U4 x 8PCS
	U6L x 1PC

Screws with washers will make the bed more stable.

# Assembly Instruction of (Bed)

## STEP 5

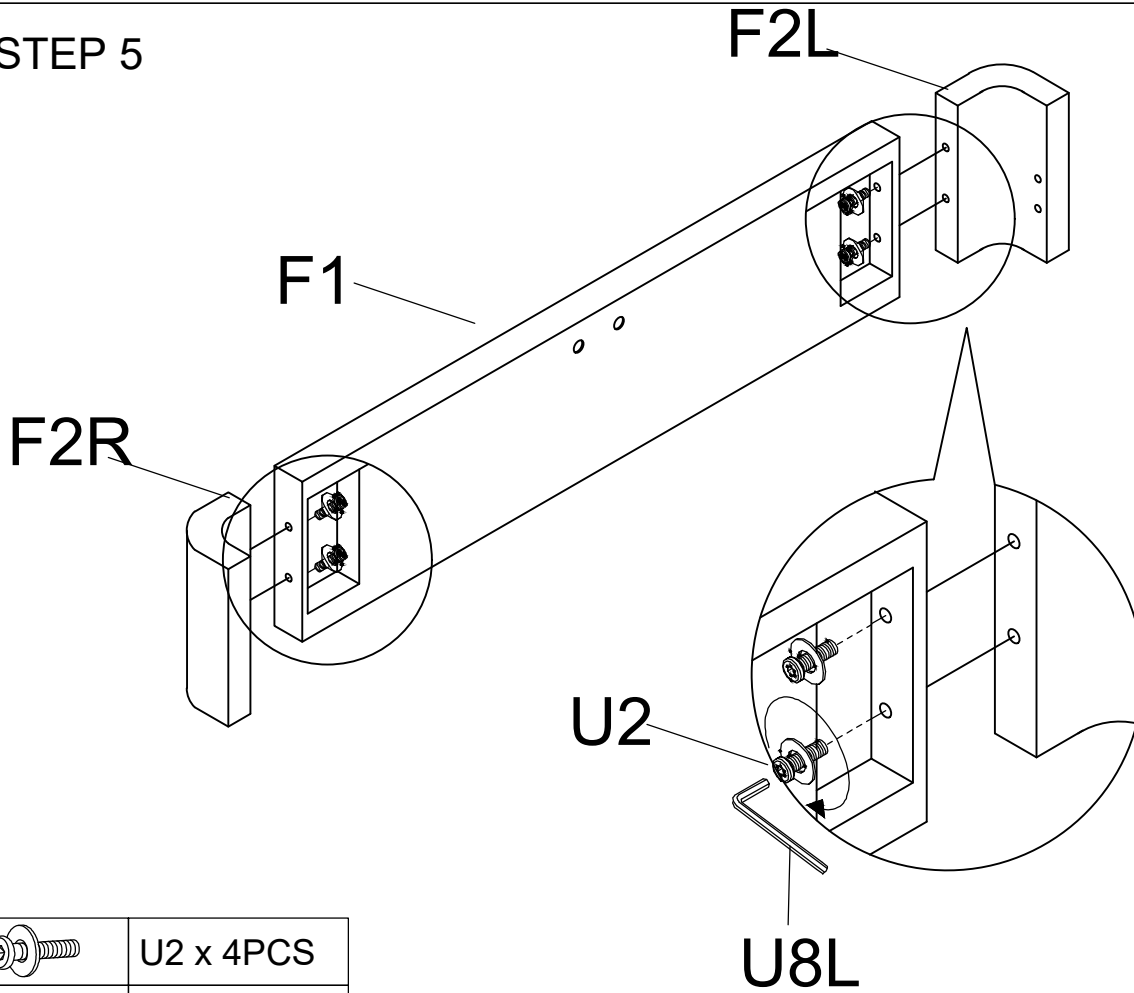



	U2 x 4PCS
	U8L x 1PC

Screws with washers will make the bed more stable.

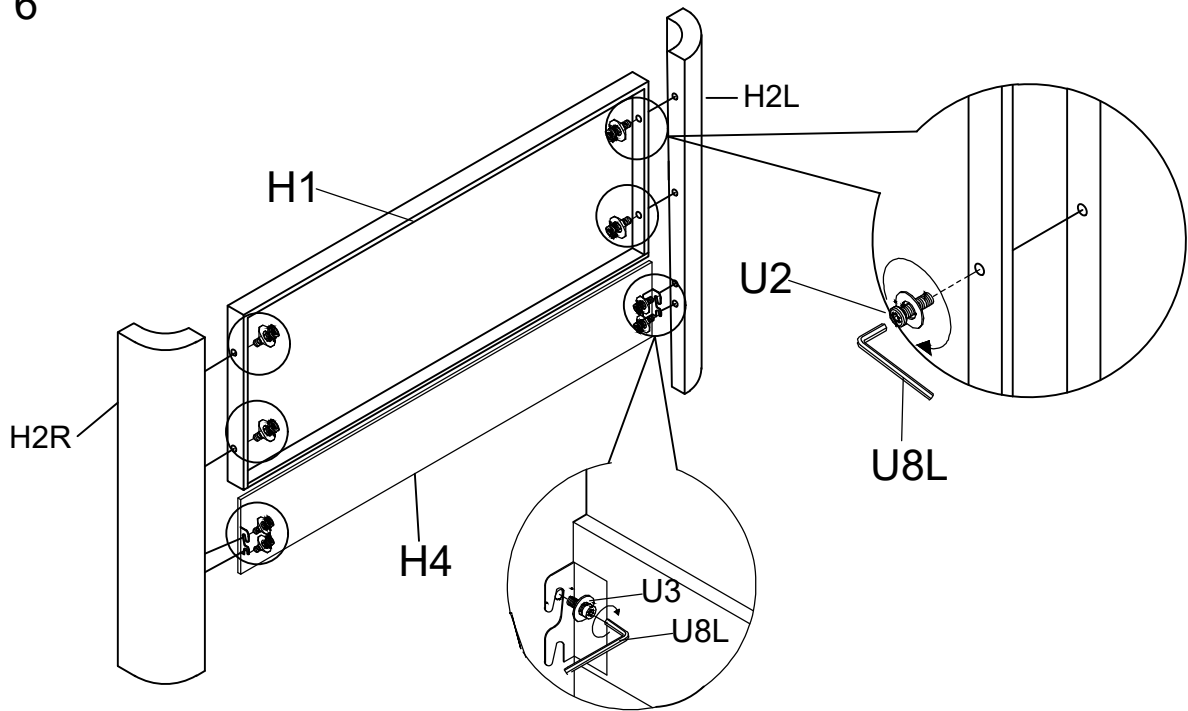
## STEP 6







	U2 x 4PCS
	U3 x 4PCS
	U8L x 1PC

Screws with washers will make the bed more stable.

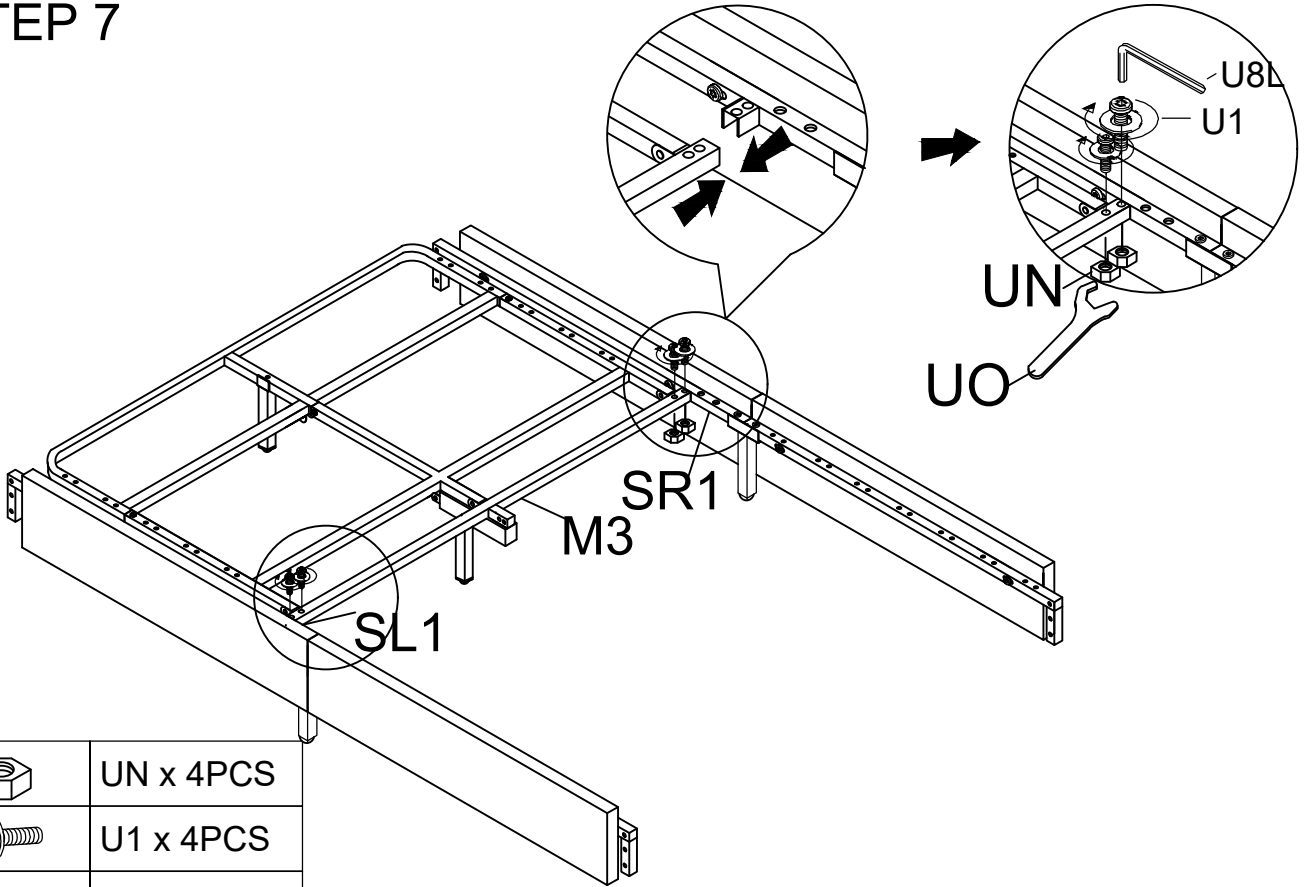
# Assembly Instruction of (Bed)

## STEP 7





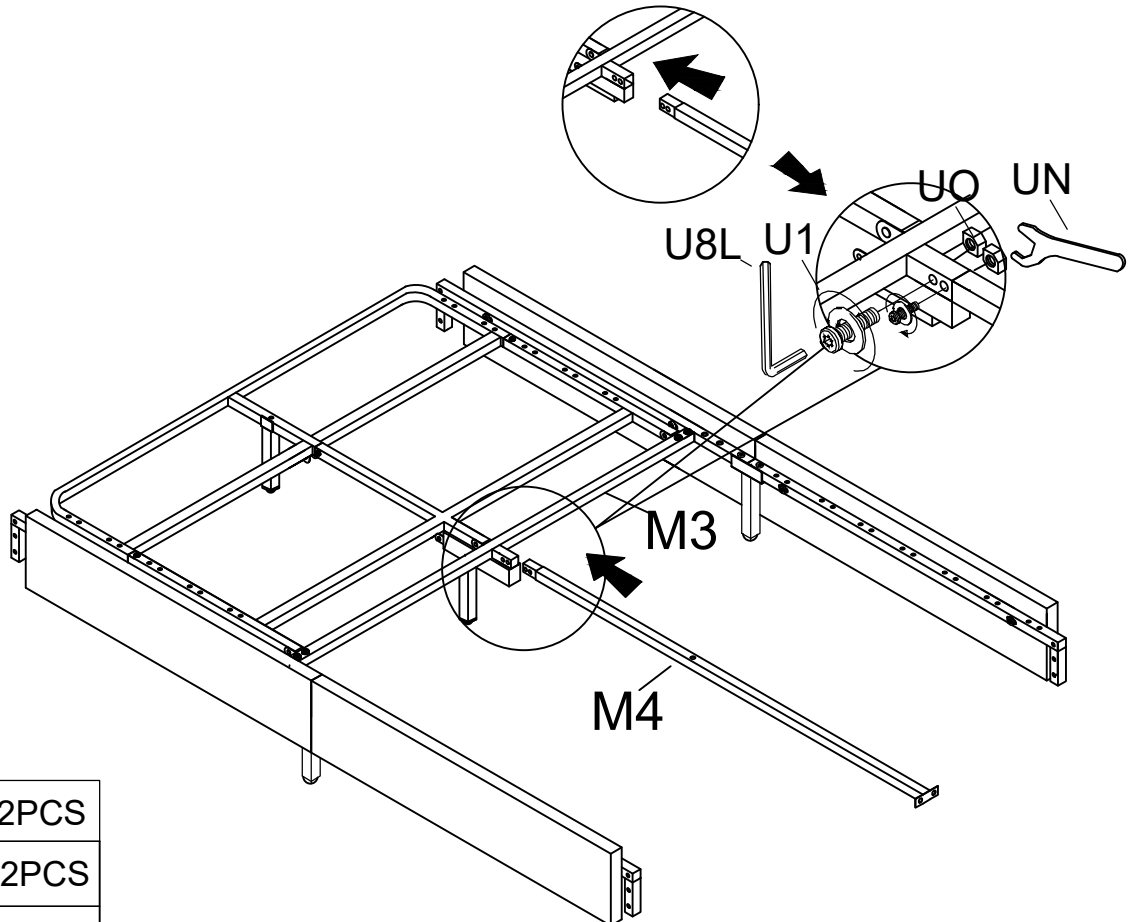

	UN x 4PCS
	U1 x 4PCS
	UO x 1PC
	U8L x 1PC

Screws with washers will make the bed more stable.

## STEP 8







	U1 x 2PCS
	UN x 2PCS
	UO x 1PC
	U8L x 1PC

Screws with washers will make the bed more stable.

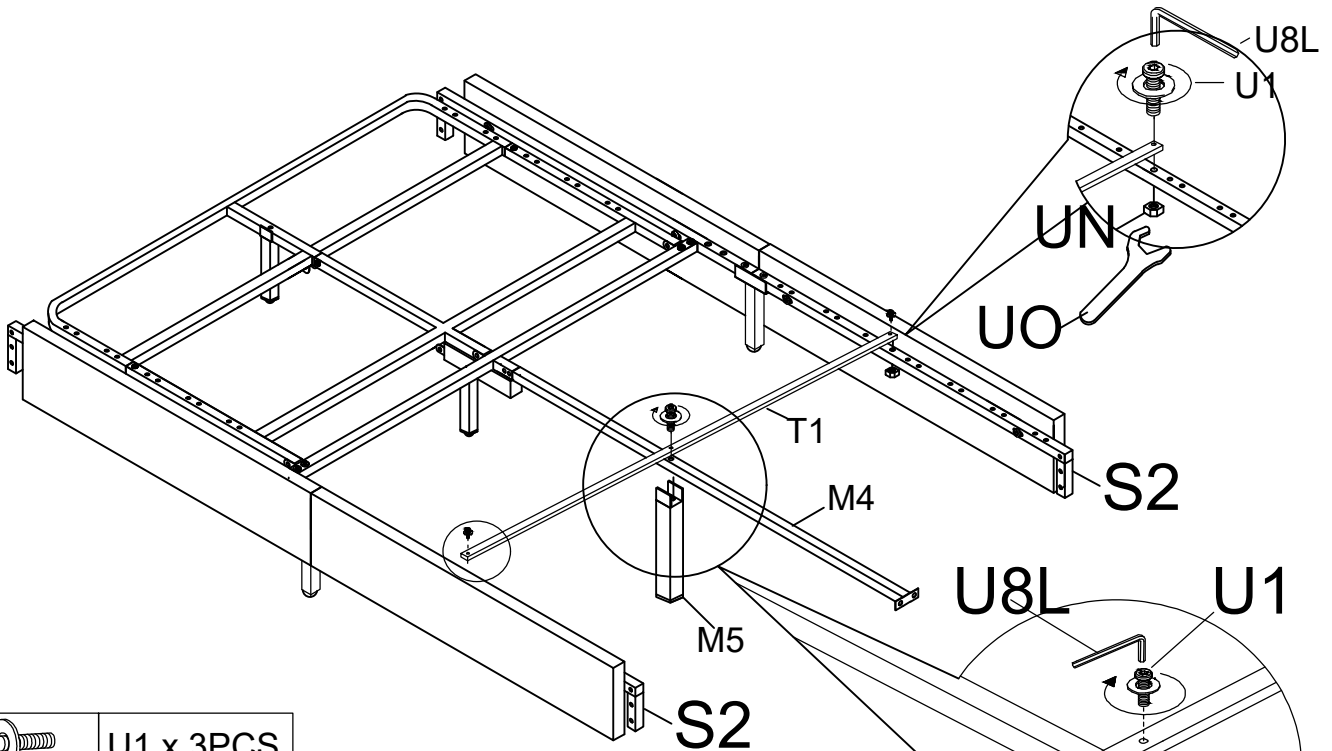
# Assembly Instruction of (Bed)

## STEP 9





	U1 x 3PCS
	UN x 2PCS
	UO x 1PC
	U8L x 1PC

Screws with washers will make the bed more stable.

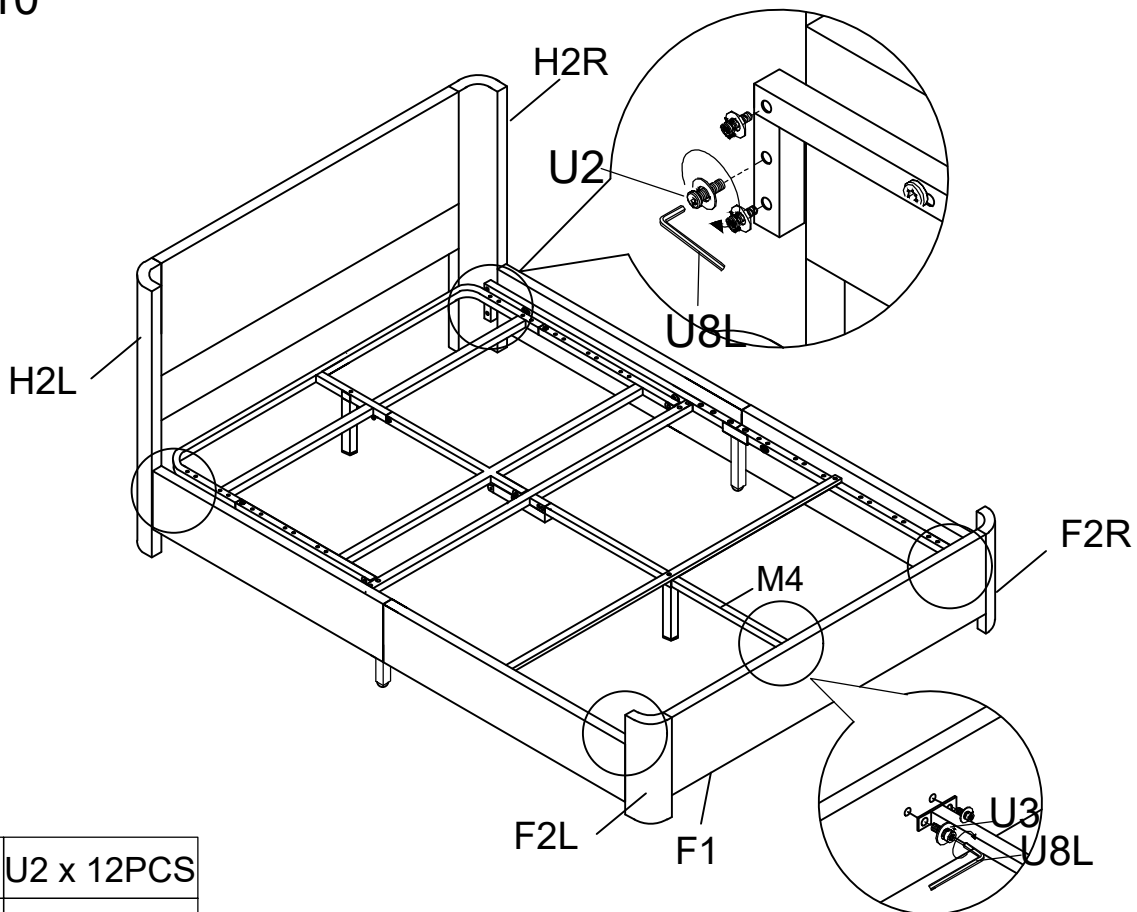
## STEP 10





	U2 x 12PCS
	U3 x 2PCS
	U8L x 1PC

Screws with washers will make the bed more stable.

# Assembly Instruction of (Bed)

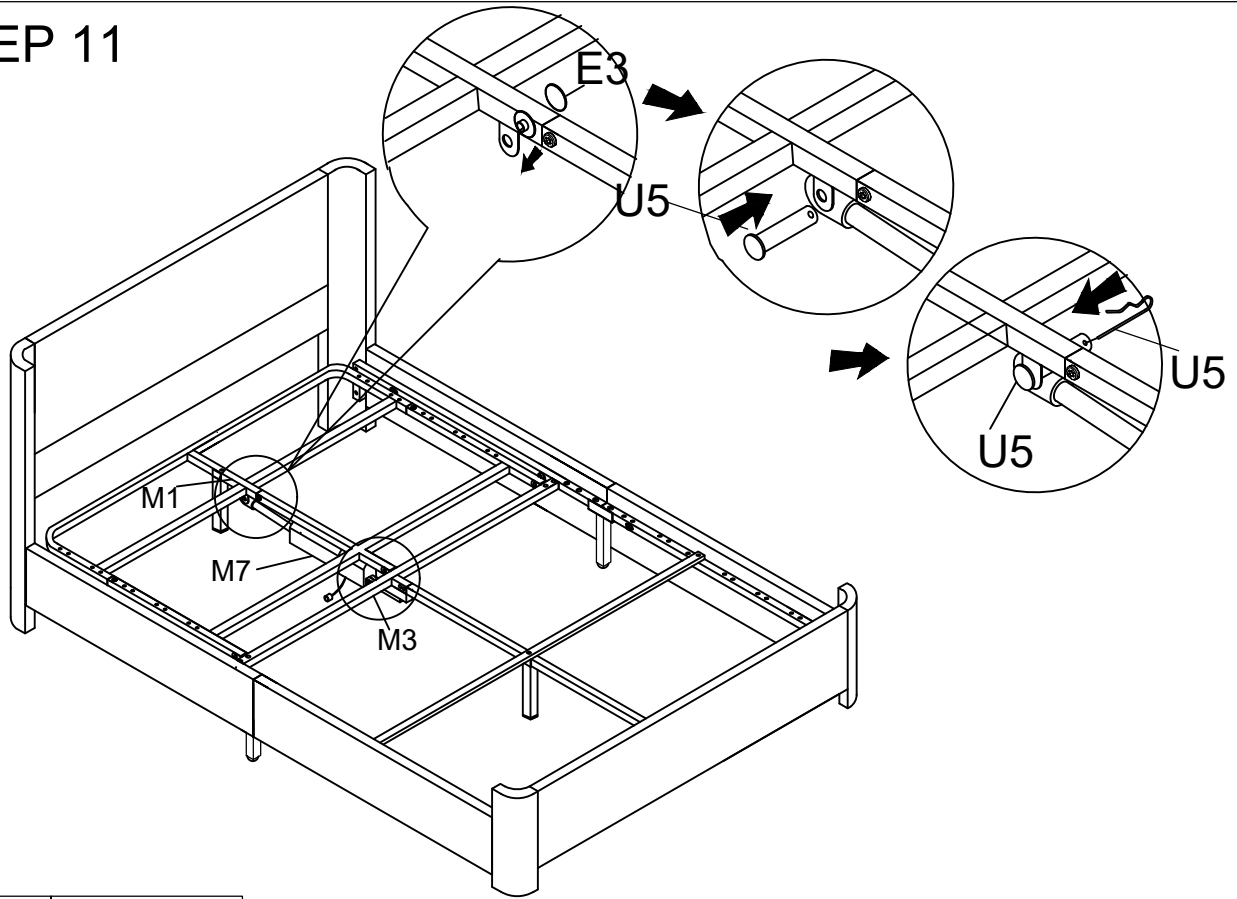
## STEP 11



	E3 x 4PCS
	U5 x 2SET

## STEP 12

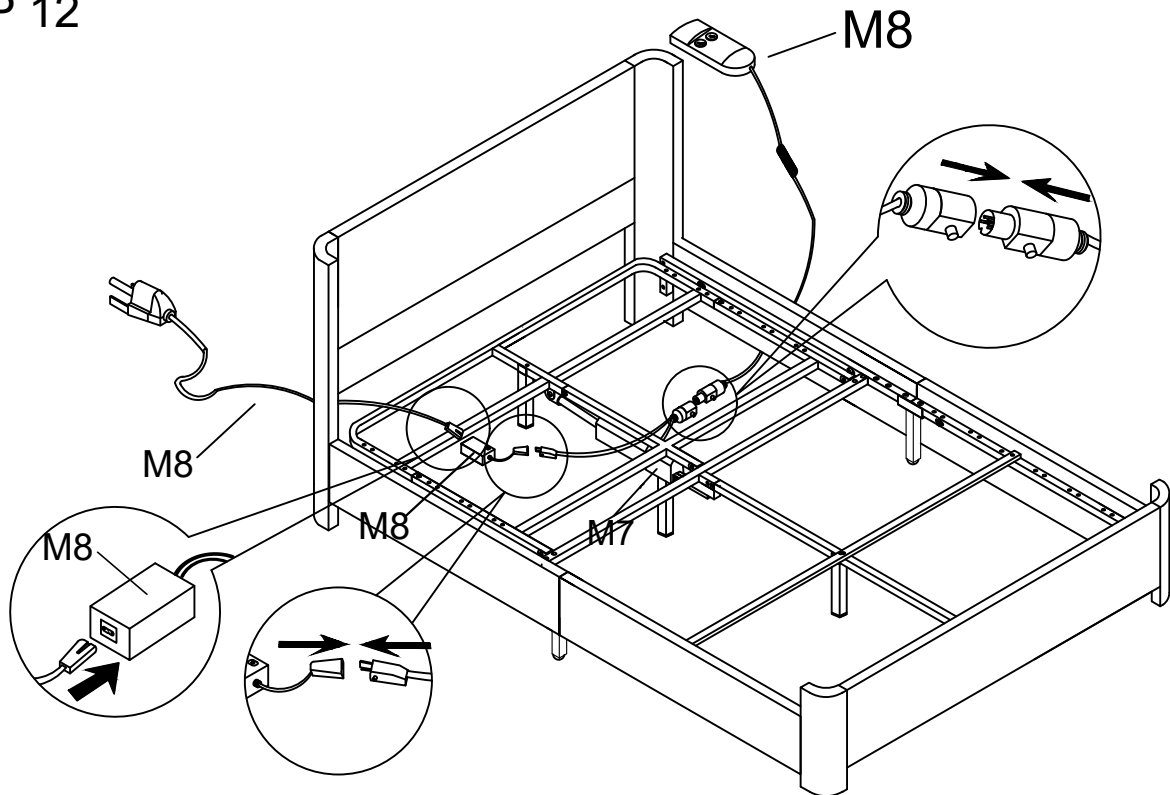

	M8 x 1SET
---	-----------

# Assembly Instruction of (Bed)

## STEP 13

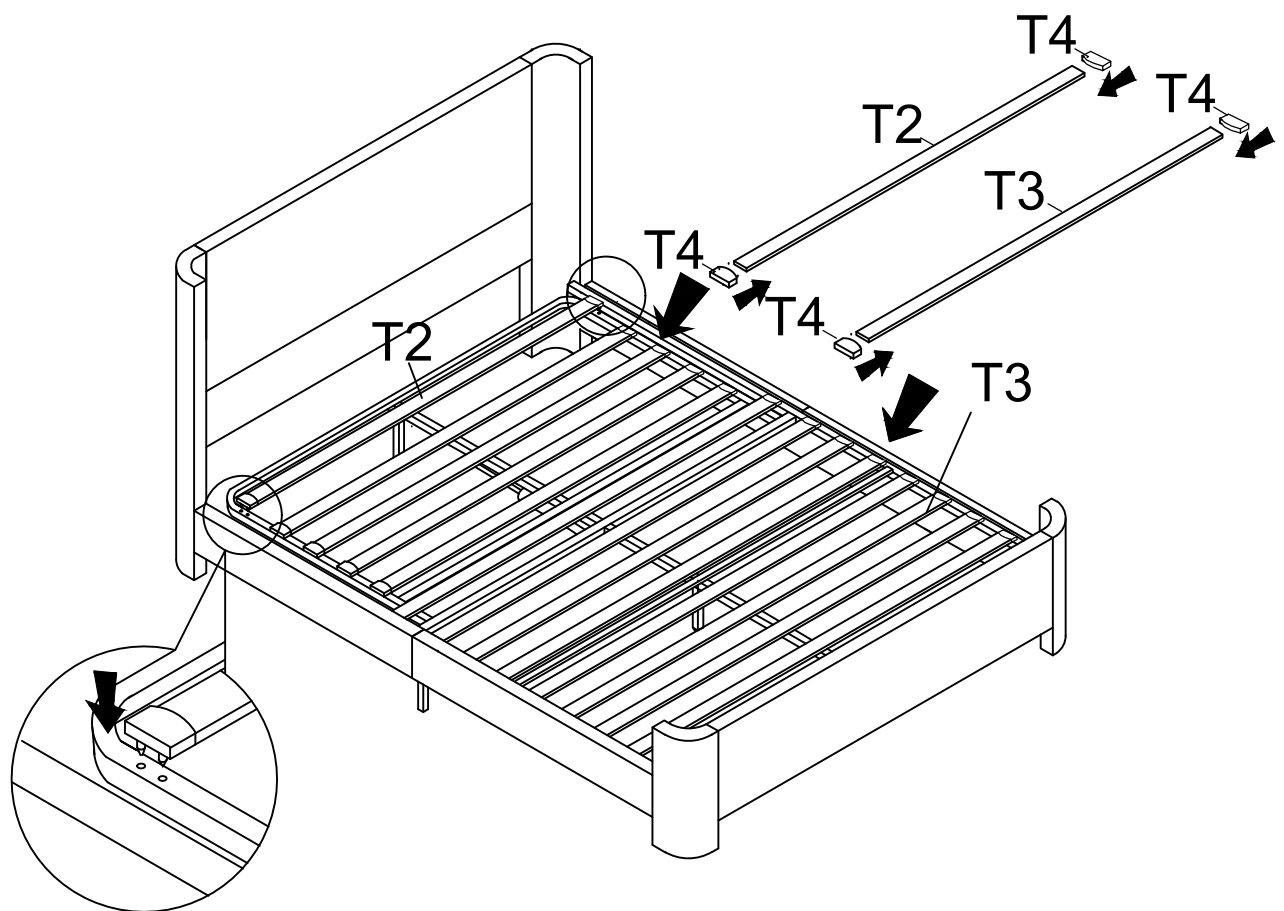

T4 x 26PCS

## STEP 14

Tips: To prevent separation at the joint, the tape can be wrapped around the joint.

Please scan the QR code on the manual/ controller and install the application.

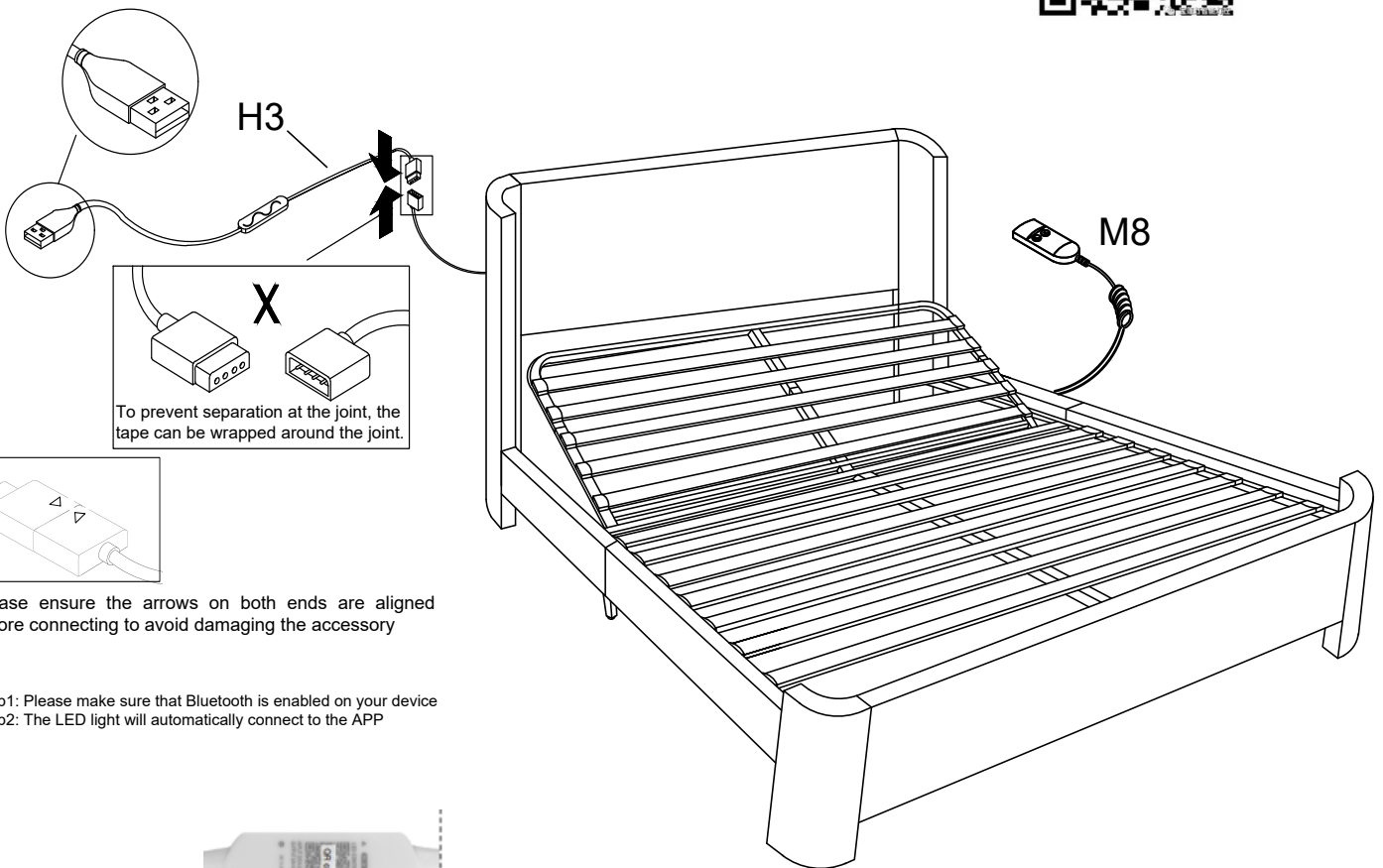

**X**

To prevent separation at the joint, the tape can be wrapped around the joint.

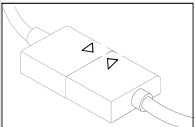

Please ensure the arrows on both ends are aligned before connecting to avoid damaging the accessory

Step1: Please make sure that Bluetooth is enabled on your device  
Step2: The LED light will automatically connect to the APP



H3 X 1SET