













**PAD-1709**

**INSTRUCTION MANUAL**

# Assembly Instructions

Caution: You must read this before you proceed

A		table top	<b>1PC</b>
B		table legs	<b>2PCS</b>
C		apron	<b>2PCS</b>
D		glass	<b>1PC</b>
E	 M6*20mm	screw	<b>4PCS</b>
F		washer	<b>20PCS</b>
G		spanner	<b>1PC</b>
H		spanner	<b>1PC</b>
I		nut	<b>8PCS</b>
J	 M6*30mm	screw	<b>8PCS</b>
P		umbrella cover	<b>1PC</b>

# Assembly Instructions

## Table

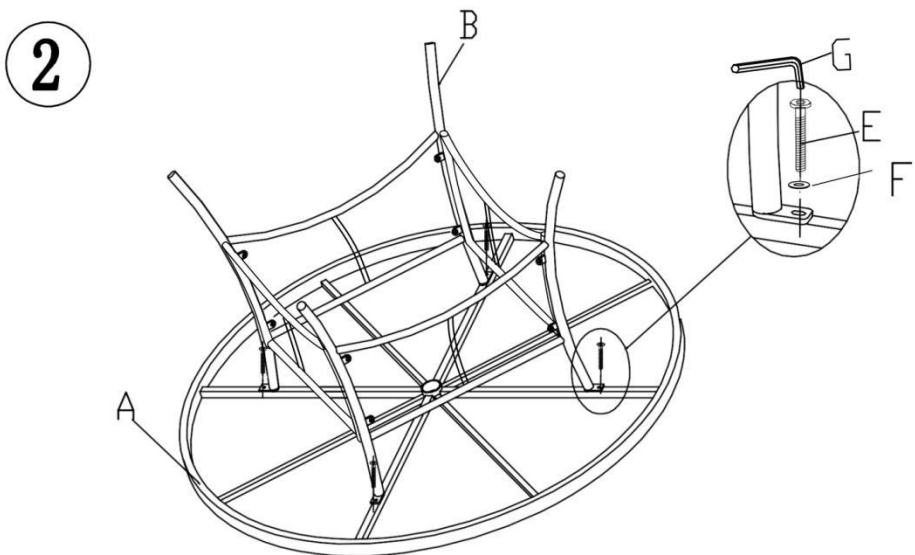
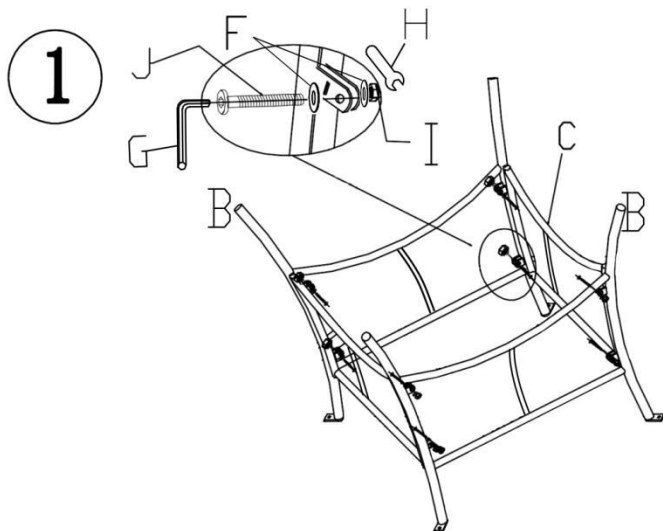

# Assembly Instructions

3

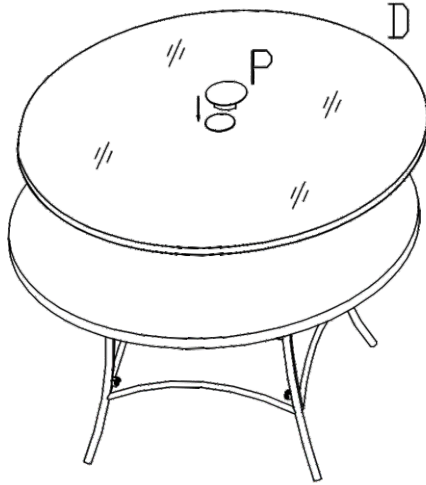

4





## Customer Instruction Card

To our most beloved and valued customer:

Thank you for your order, and we appreciate your trust and support.

If you need any assistance or have any questions about your order, please reach our customer service team with your order number at:

**Direct Wicker Corp Tel: (813) -304-1389**

ET: 9 AM - 5 PM, Monday - Friday

If you would like to know more about Direct Wicker or need to forward documents, you can also reach us at: **customerservice@directwicker.com**

Our team will always be here to help.

### Common Questions:

1. Normally the cushion is placed within the ottoman/ chair, please turn it upside down, you may find the cushion.
2. Please do not fully tighten the screws before all parts were assembled successfully, in case the products can not be lined up in position.
3. Furniture sets are mostly delivered in multiple cartons. If the numbers of boxes you received are not correct/missing. Please contact us via phone or email with your order number.
4. If you would like to return the order, be sure to also return any accessories and packing slips that came with your original package.
5. If the set is not in use for a long time, please cover it with a furniture cover or store it indoors.
6. Please be very careful with the glass, please do not handle the glass with bare hands if it was broken.

Thank you for your understanding and cooperation, we wish you a fantastic shopping experience with us, and we are looking forward to serving you again!

*Direct Wicker Team*

A stylized illustration of a hand holding a bouquet of flowers. The bouquet consists of several stems with small, light blue and pink flowers. The flowers are wrapped in a light-colored, textured paper. The hand is shown from the bottom right, holding the base of the bouquet.

Your Home Our Passion



For more information, please visit our website:  
[www.directwicker.com](http://www.directwicker.com)