

Please consult your electrician for hanging fixture and wiring.

CA2459-H

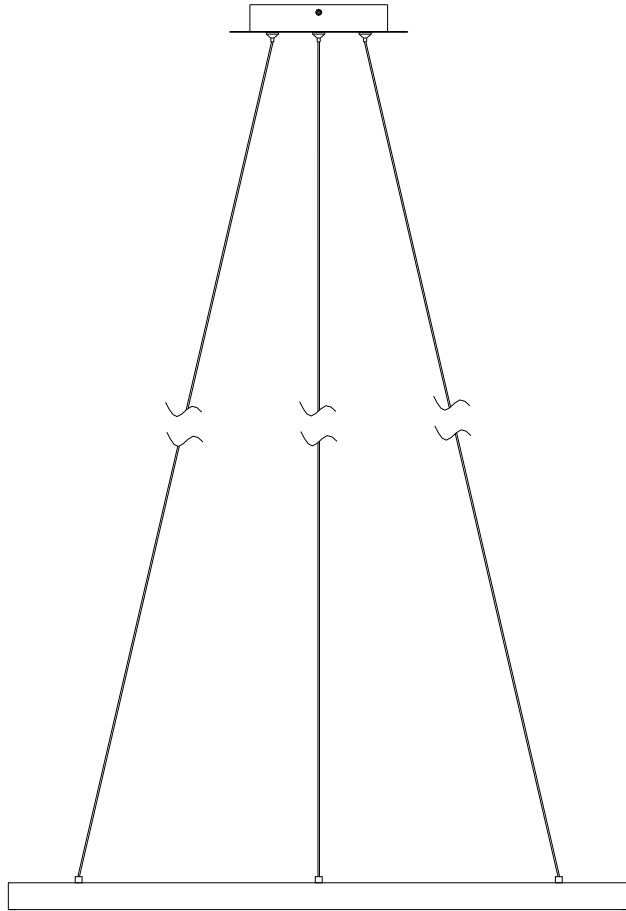

IMPORTANT: Turn off the power at the main fuse or circuit breaker box before starting installation



Bracket

Locate all hardware & components before discarding packaging

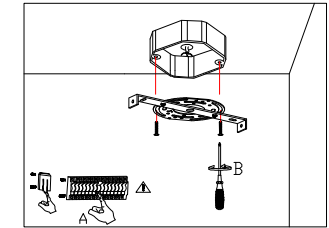
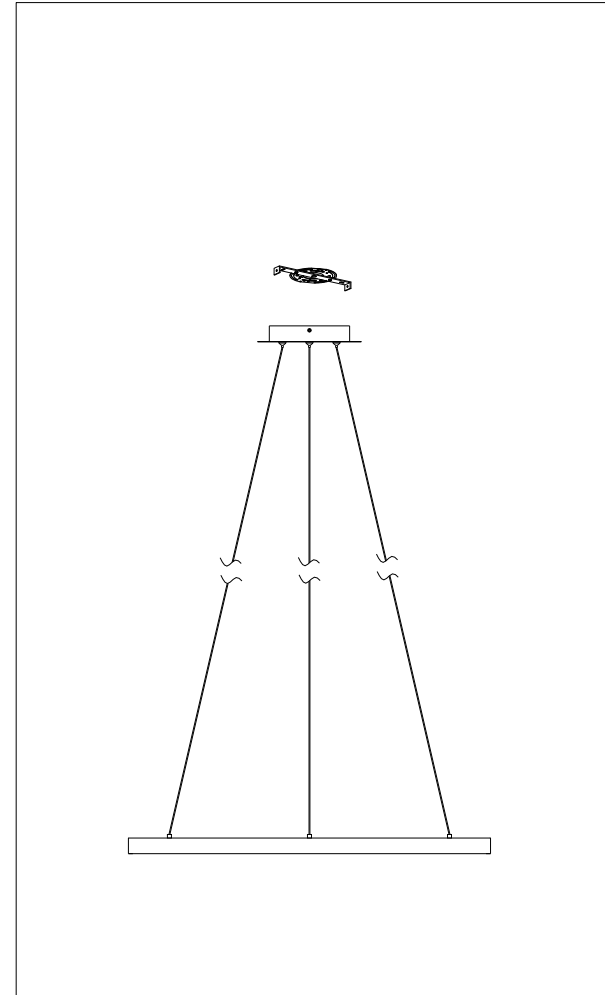

1.)

Step 1: Remove mounting bracket from fixture and install it to electrical box.

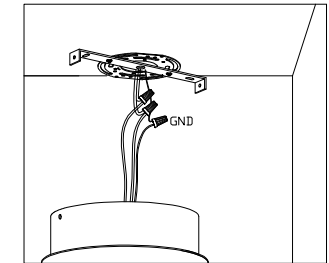

2.)

Step 2: Wire fixture to wires in outlet box. Green wire is for ground.

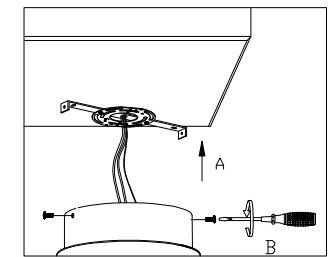

3.)

Step 3: Install fixture to back-plate and tighten worm screws so that fixture meets the wall.

Cleaning & Care:
Clean with soft cloth and a mild detergent.
Do not use abrasive cleaner.