

Assembly Instruction







Love Seat

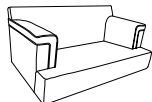
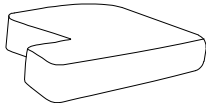
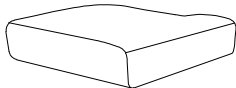

Legs & hardware are packed in the box and stored at the bottom of the seat, please take out for assembly.

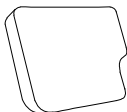
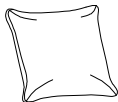
Note: Do not use power tools for assembly. Power tools increase the risk of over tightening which lead to splitting or cracking the wood.

Component list

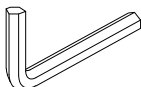
No	Drawing	Qty	Description
A		1	Love seat
B		1	Left seat cushion
C		1	Right seat cushion
D		1	Left back cushion
E		1	Right back cushion
F		4	Pillows (18"*18")
G		4	Legs (150*130*100*50mm)
H		8	Bolt 65mm (5/16*65mm)
I		8	Flat washer (5/16*Ø16*1.5mm)
J		1	Allen key (M4*59mm)

THE PARTS ARE LOCATED INSIDE THE BOX AS BELOW:

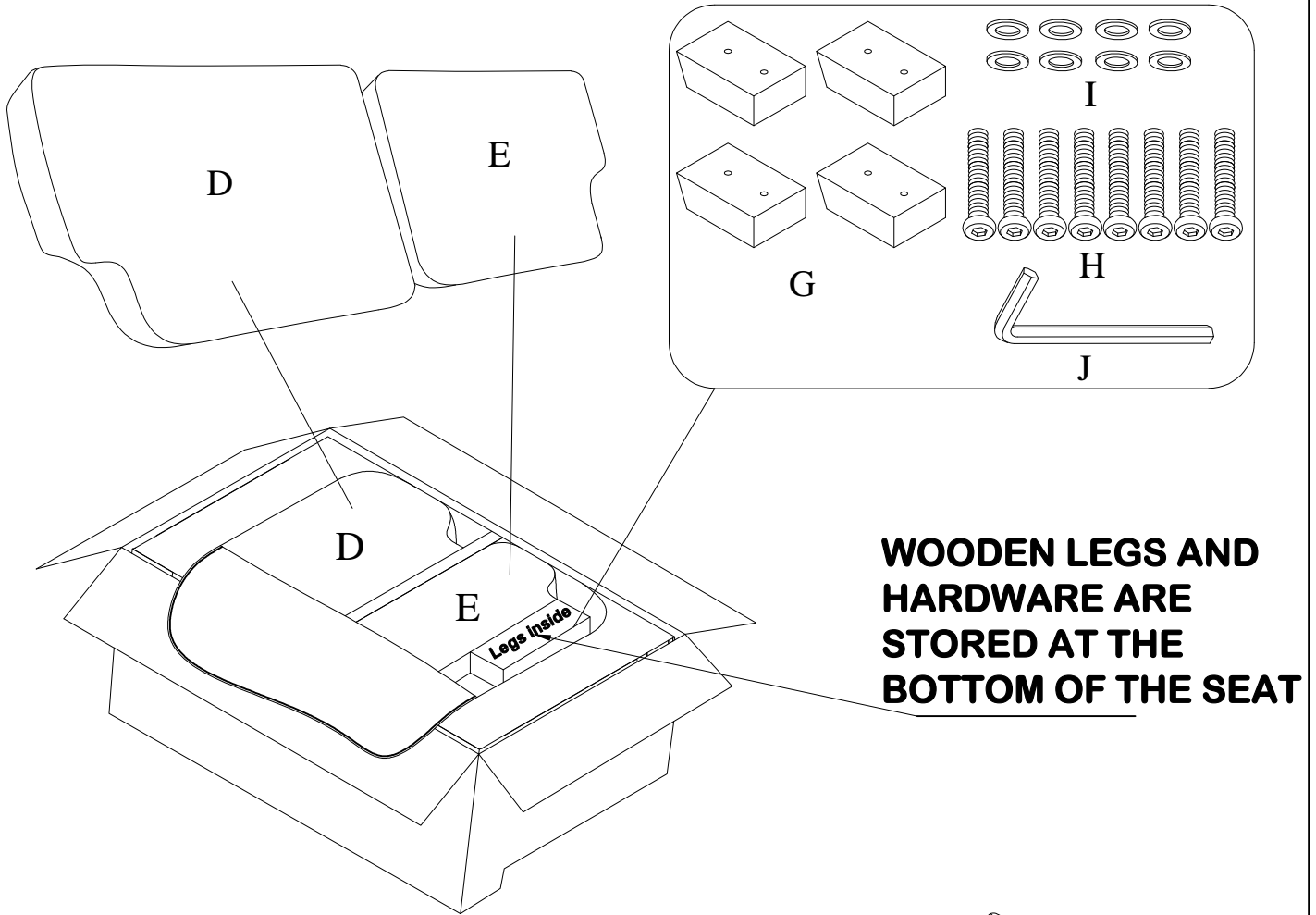

**WOODEN LEGS AND
HARDWARE ARE
STORED AT THE
BOTTOM OF THE SEAT**

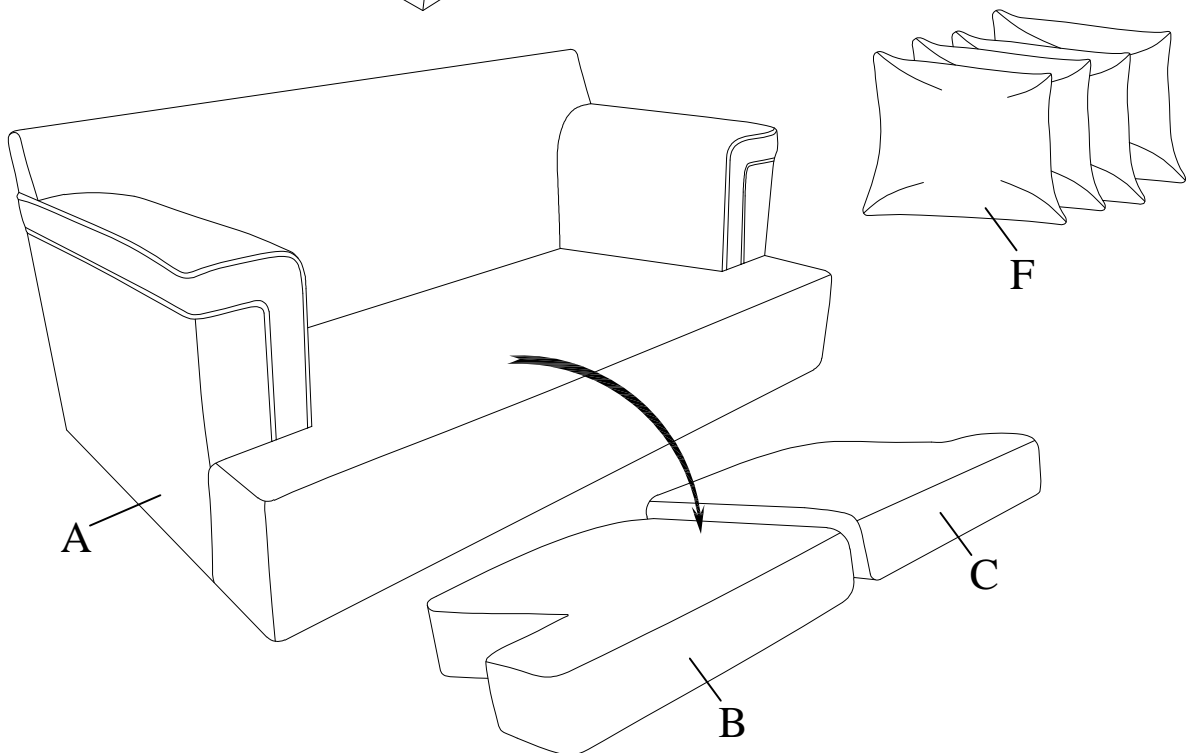

Step #1

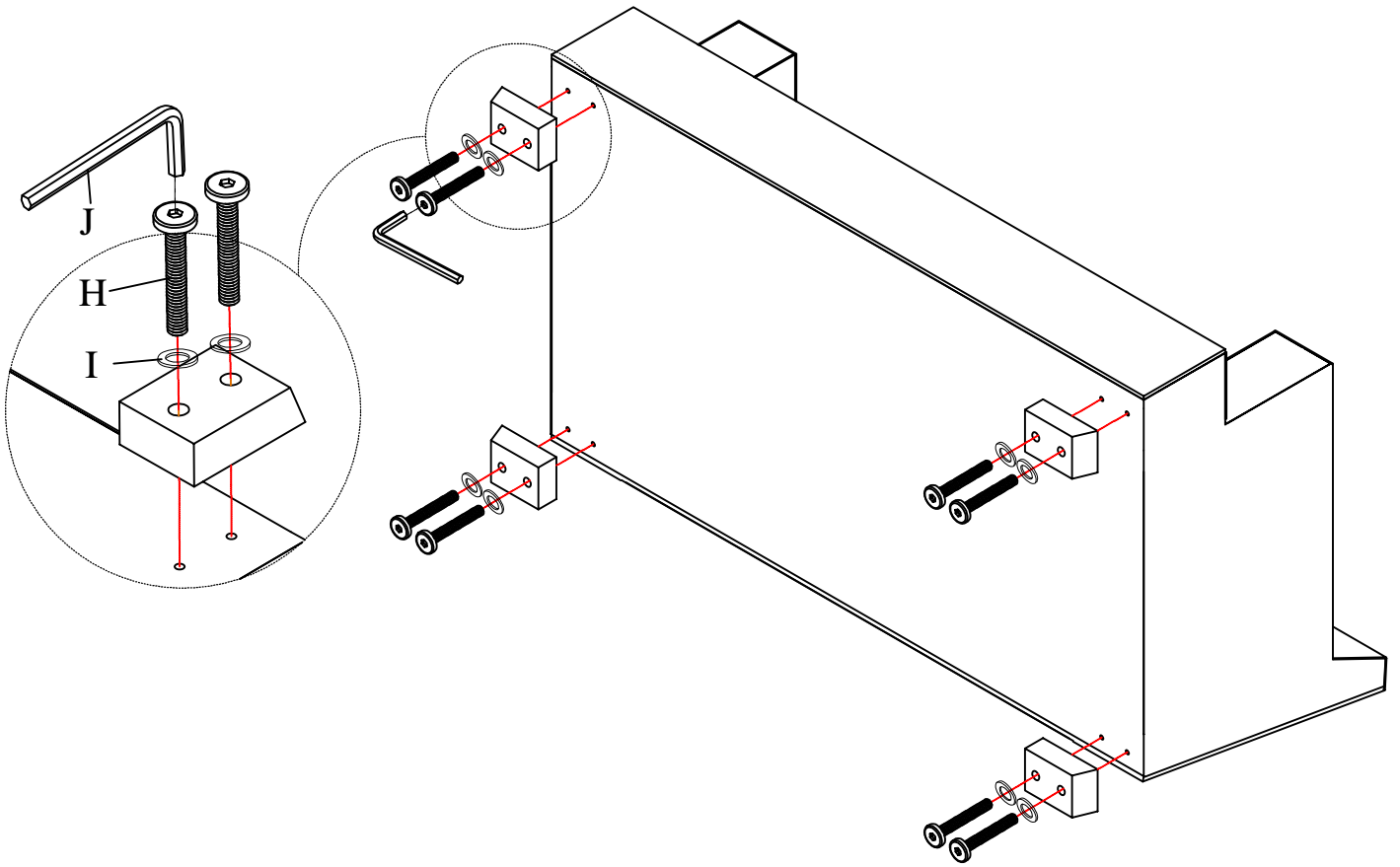

Step #2

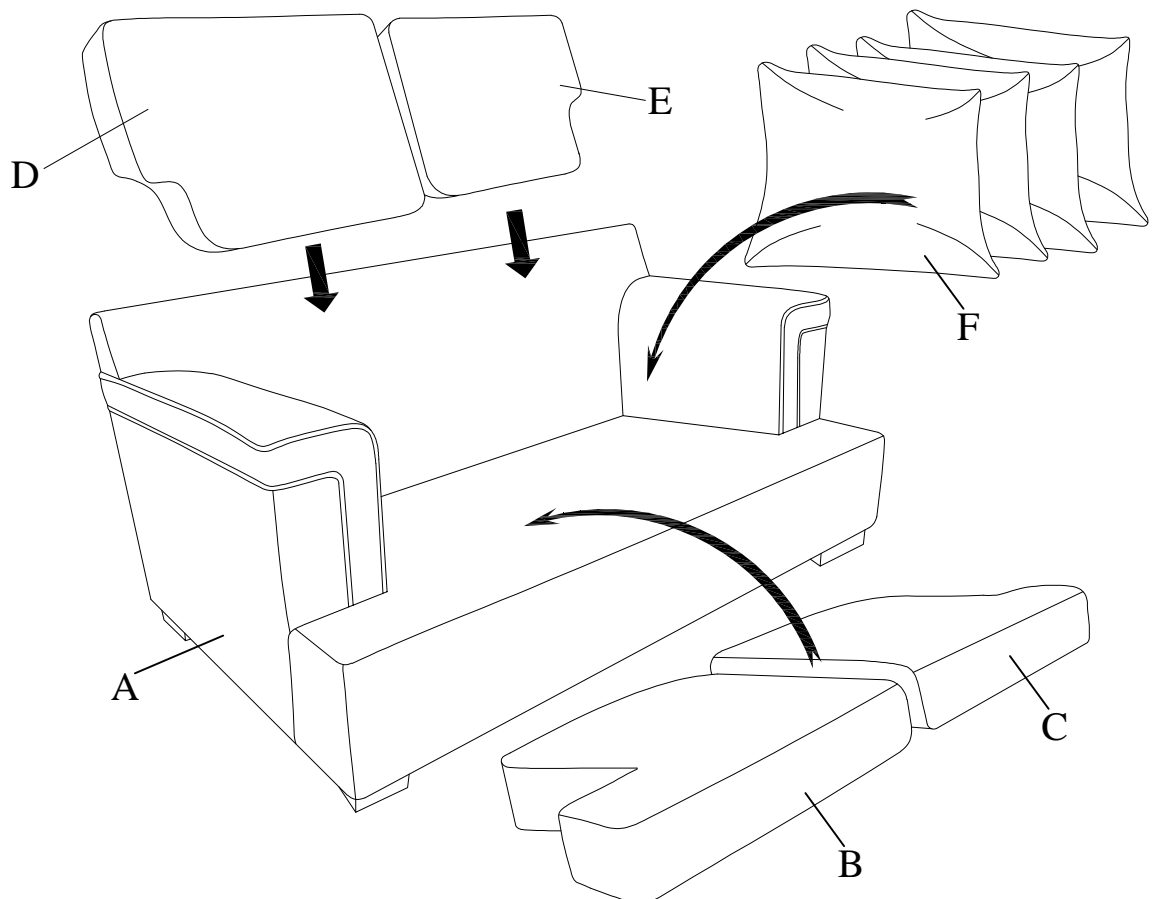

Step #3

Assembly completed.

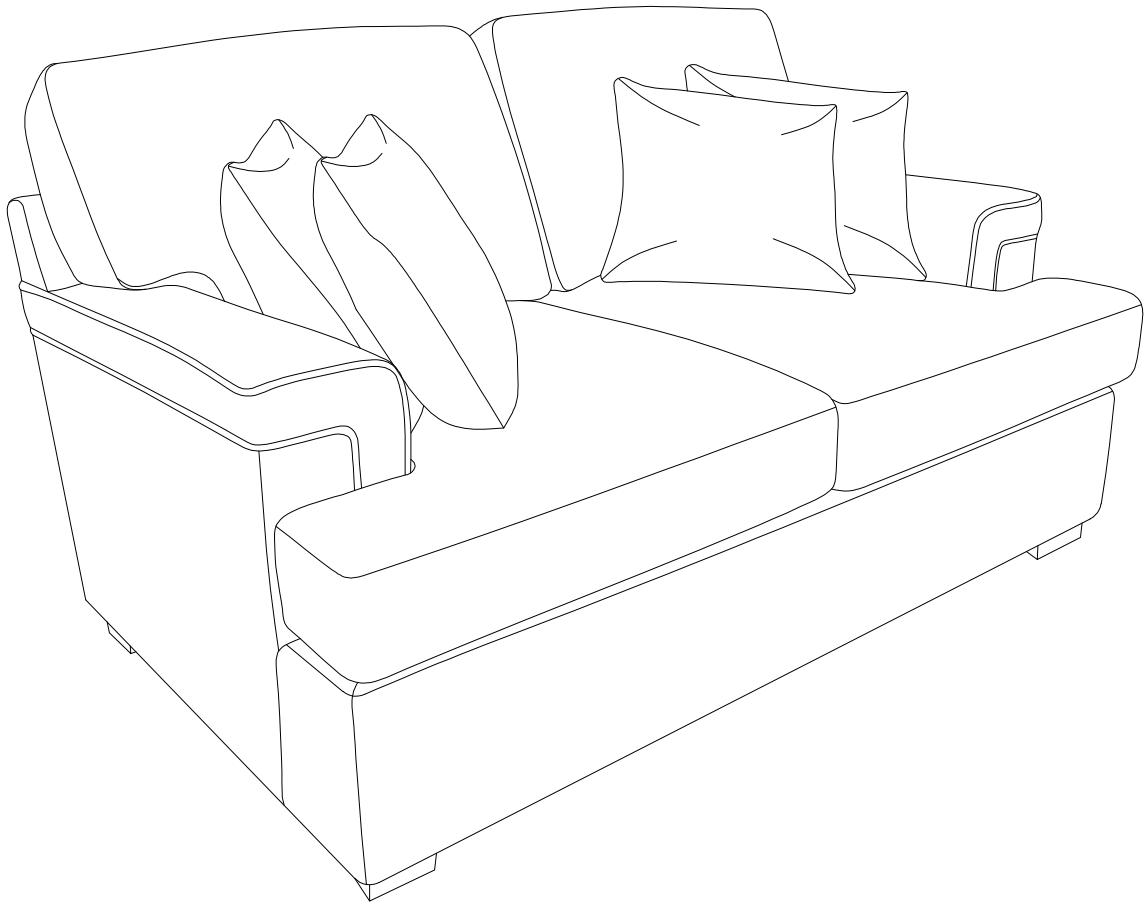

Care Instruction for chenille fabric Furniture:

In order to maintain the original appearance of your chenille fabric, please follow below simple care procedures:

- Avoid exposing furniture directly to sunlight or heating and air conditioning outlets. Sunlight and/or exposure to heating and air conditioning outlets will fade/damage chenille fabrics. Do not place your upholstered furniture too close to windows, radiators, or vents, and be sure to use windows, radiators, or vents.
- Vacuum or wipe with a soft cloth to remove dust.
- Hardware may loosen over time. Periodically check to make sure all connections are tight. Re-tighten if necessary.



For items use on wooden floor, hard surfaces or carpets, it is recommended to Install protective pads under all legs and supports to avoid/prevent from damages/scratches and discoloration.