

User Manual

(Manual del Usuario)

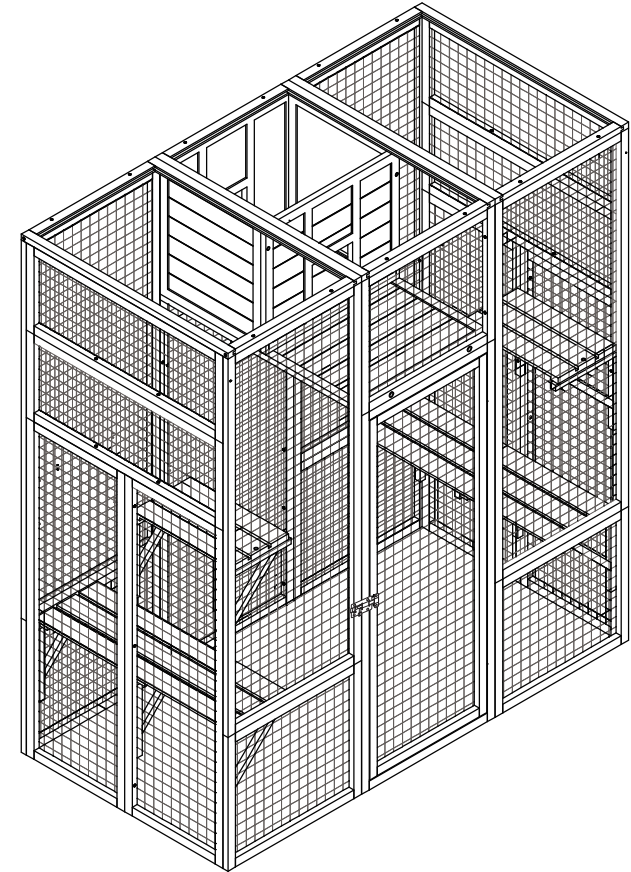

Model Number: CWP0381
(Número del Modelo)

EN

Dear Customer,

Thank you for your purchase.

COZIWOW is committed to providing affordable high-quality pet products worldwide.

We take your pet's needs and well-being as the greatest mission.

We are proud to make a difference in thousands of pets' life.

When you receive the product, please make sure that all the parts are intact.

Then please browse the entire installation manual before assembly.

If problems occur unsatisfactorily as follows:

a. The outer box is damaged.

b. The product is damaged / bent / cracked while you open the box.

c. The parts / accessories / assembly tools are missing.

d. The product is hard to assemble.

e. The instructions are not clear and can not be referred to.

f. The product has functional problems.

g. Other aspects that you are not satisfied with.

Please do not hesitate to contact us for help (Be sure to mark the **SKU NUMBER**, e.g., CW12S0462, and the **TRACKING NUMBER**).

Our COZIWOW team with factory direct after-sales service will reply within 24 hours and will do our best to resolve the problem for you. Our services are available at any time.

For more information, please browse <https://www.coziwow.com/>

Sincerely,
COZIWOW Team

**COZIWOW,
Free combination, Cozy home!**

ES

Estimado Cliente,

Gracias por su compra.

COZIWOW se compromete a proporcionar productos para mascotas de alta calidad y asequibles en todo el mundo.

Tomamos las necesidades y el bienestar de su mascota como la misión más importante.

Estamos orgullosos de producir un gran impacto en la vida de miles de mascotas.

Cuando reciba el producto, asegúrese de que todas las piezas estén intactas.

Luego, por favor revise todo el manual de instalación antes del ensamblaje.

Si ocurren problemas insatisfactorios como sigue:

a. La caja exterior está dañada.

b. El producto está dañado / doblado / agrietado después de abrir la caja.

c. Faltan piezas / accesorios / herramientas de ensamblaje.

d. El producto es difícil de ensamblar.

e. Las instrucciones no son claras y no se pueden consultar.

f. El producto tiene problemas funcionales.

g. Otros aspectos con los que no esté satisfecho.

Por favor no dude en contactarnos para obtener ayuda (Asegúrese de marcar el **NÚMERO DE SKU**, por ejemplo, CW12So462 y el **NÚMERO DE SEGUIMIENTO**).

Nuestro equipo de COZIWOW con servicio postventa directo de la fábrica responderá en un plazo de 24 horas y hará todo lo posible para resolver el problema por usted. Nuestros servicios están disponibles en cualquier momento.

Para obtener más información, por favor visite <https://www.coziwow.com/>

Sinceramente,
Equipo COZIWOW

**COZIWOW,
Libre la Combinación, Cómoda la Casa!**

You need (Usted Necesita)

① Tools required
(Herramientas requeridas)

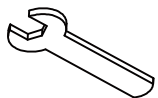









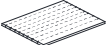

② 2 persons needed
(Se necesitan 2 personas)



Hardware List

(Lista de Accesorios)

			
① 6PCS (Piezas)	② 6PCS (Piezas)	③ 4PCS (Piezas)	④ 3PCS (Piezas)
			
⑤ 2PCS (Piezas)	⑥ 2PCS (Piezas)	⑦ 2PCS (Piezas)	⑧ 4PCS (Piezas)
			
⑨ 1PC (Pieza)	⑩ 2PCS (Piezas)	⑪ 1PC (Pieza)	⑫ 1PC (Pieza)

PRODUCT ASSEMBLY (Ensamblaje del Producto)

STEP 11/ Paso 11

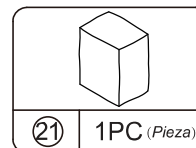

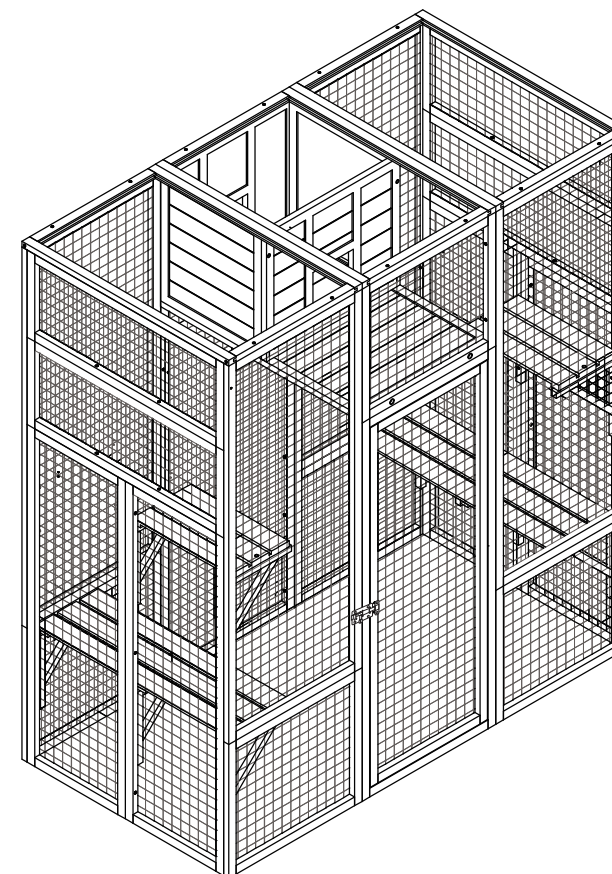

Open Part 21 and fit it over the product outer frame.
(Abra la pieza 21 y colóquela sobre el marco exterior del producto.)





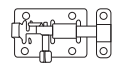



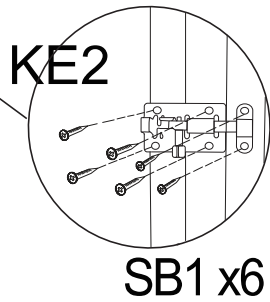
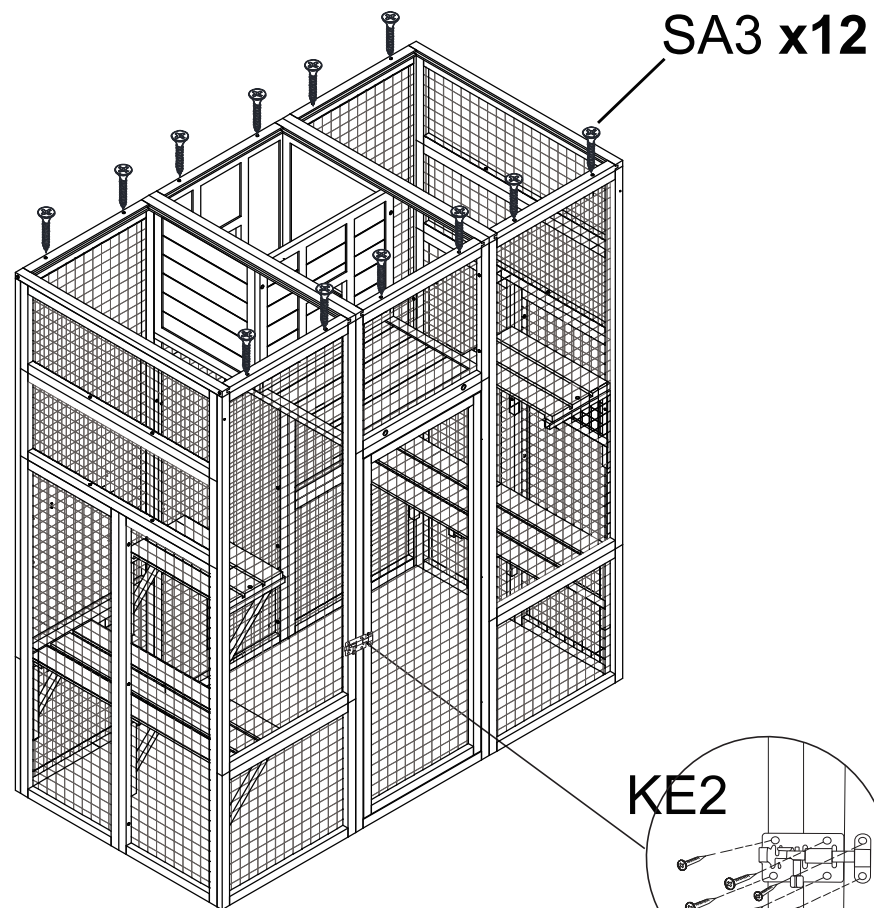



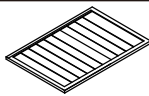
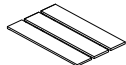

PRODUCT ASSEMBLY (Ensamblaje del Producto)

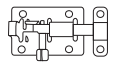
STEP 10/ Paso 10

		
KE2 1PC (Pieza)	SB1 6PCS (Piezas)	SA3 12PCS (Piezas)



			
13 1PC (Pieza)	14 2PCS (Piezas)	15 1PC (Pieza)	16 1PC (Pieza)
			
17 2PCS (Piezas)	18 2PCS (Piezas)	19 1PC (Pieza)	20 1PC (Pieza)
			
21 1PC (Pieza)			
			
KE2 1PC (Pieza)	M4x50mm SA1 50PCS (Piezas)	M4x35mm SA3 80PCS (Piezas)	M4x25mm SA4 16PCS (Piezas)
			
M3x16mm SB1 6PCS (Piezas)	KA1 10PCS (Piezas)	KD7 1PC (Pieza)	

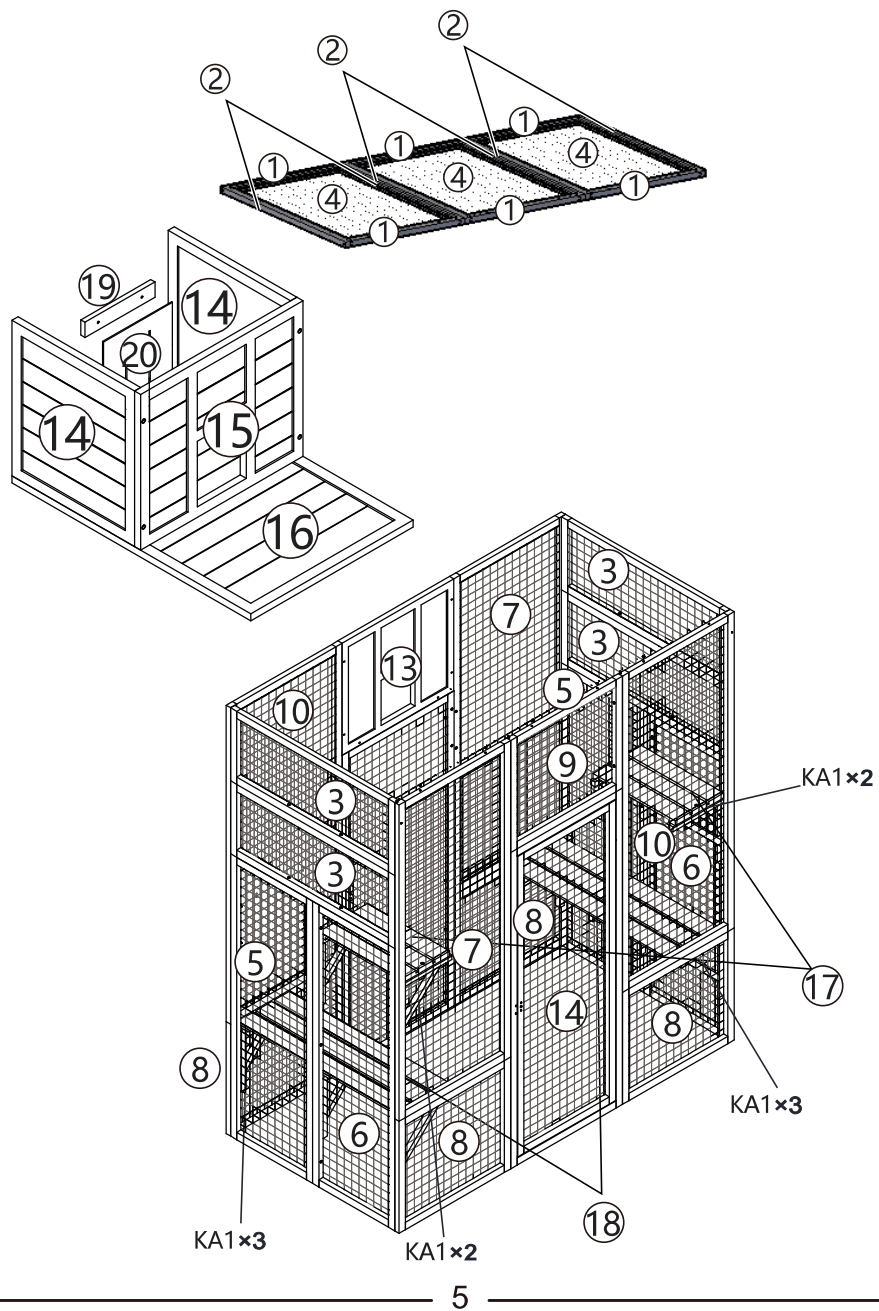

STEP 9/ Paso 9

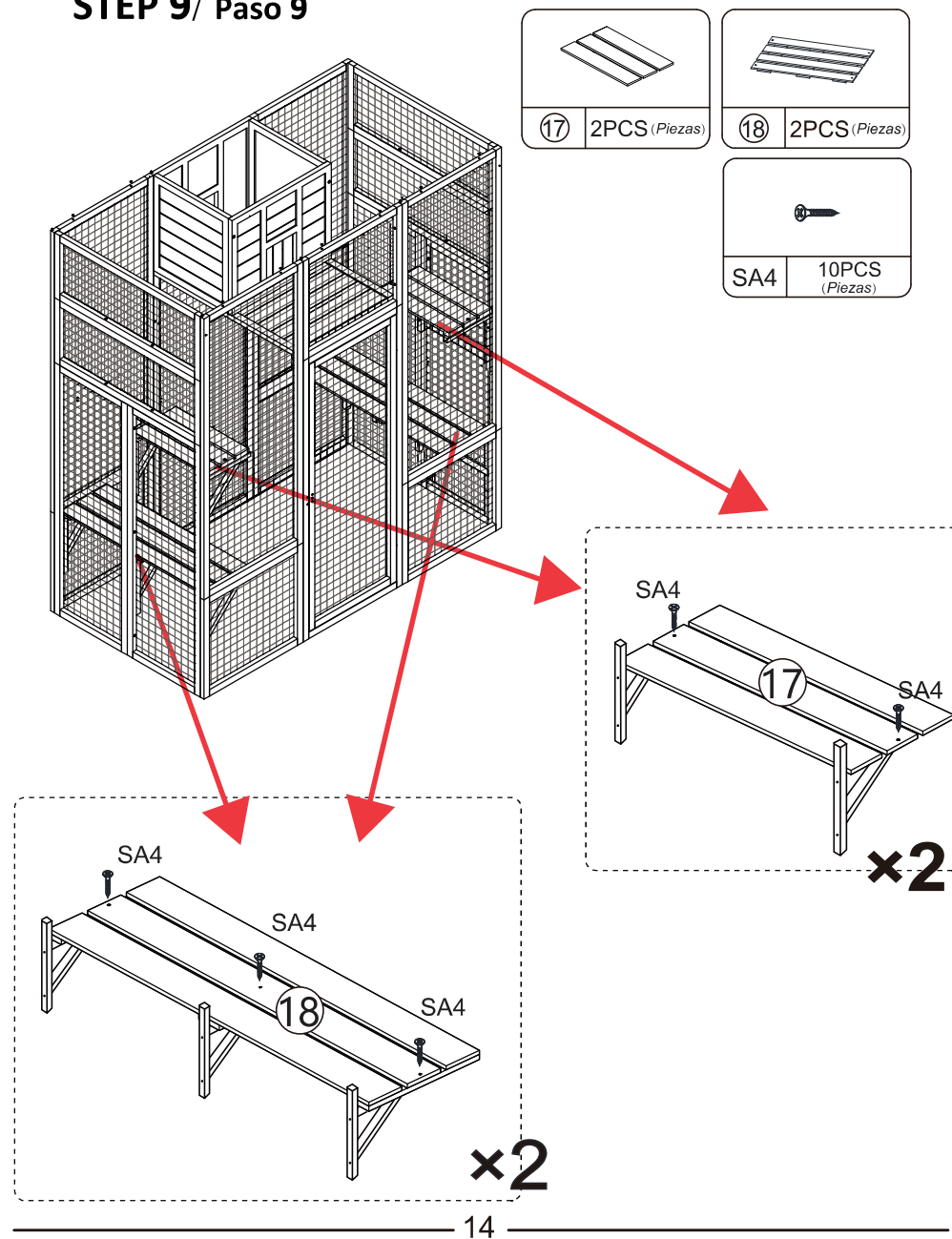

PRODUCT ASSEMBLY (Ensamblaje del Producto)

STEP 8/ Paso 8

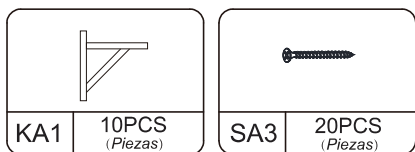

KA1 x10

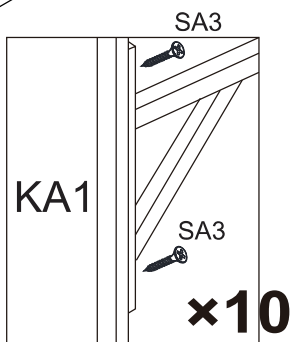
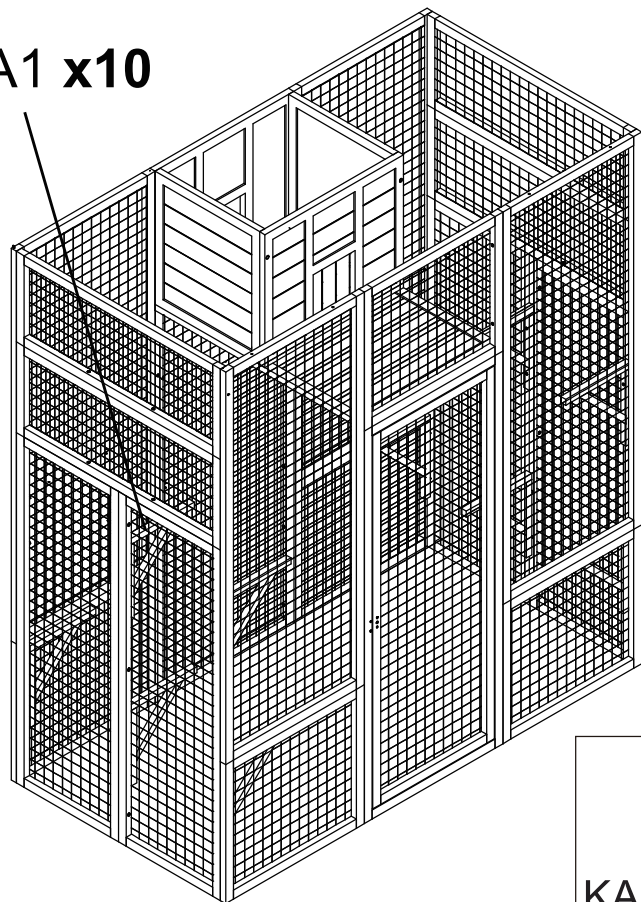







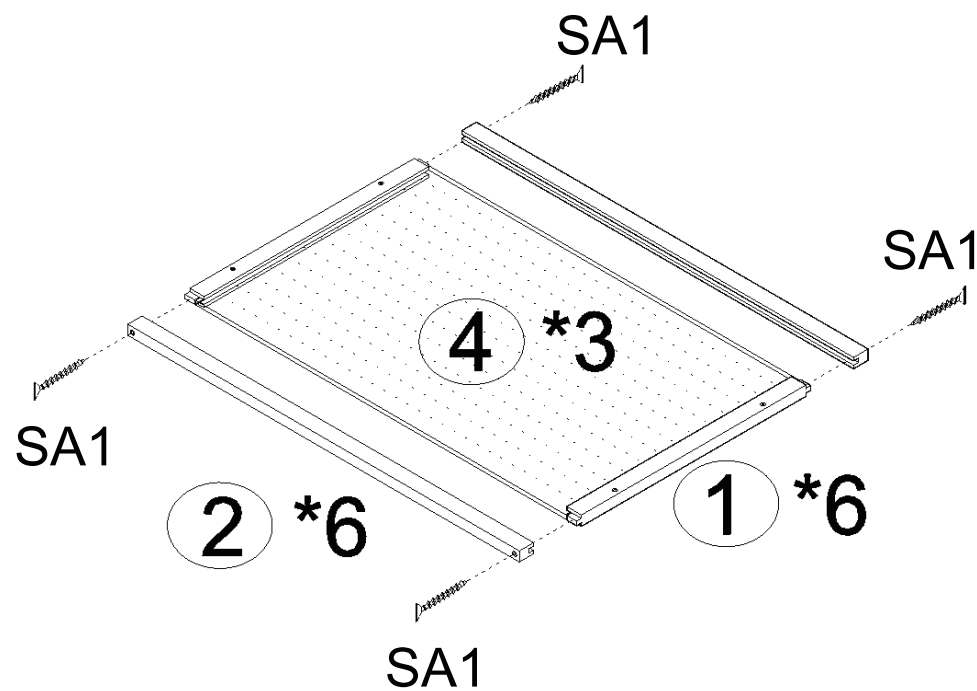
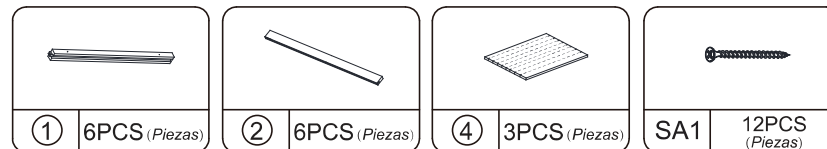

PRODUCT ASSEMBLY (Ensamblaje del Producto)

! Check the package contents before getting started!
(¡Revise el contenido del paquete antes de comenzar!)

STEP 1/ Paso 1



STEP 2/ Paso 2

			
③ 2PCS (Piezas)	⑤ 1PC (Pieza)	⑥ 1PC (Pieza)	⑦ 1PC (Pieza)
			
⑧ 2PCS (Piezas)	⑩ 1PC (Pieza)	SA1 7PCS (Piezas)	SA3 16PCS (Piezas)

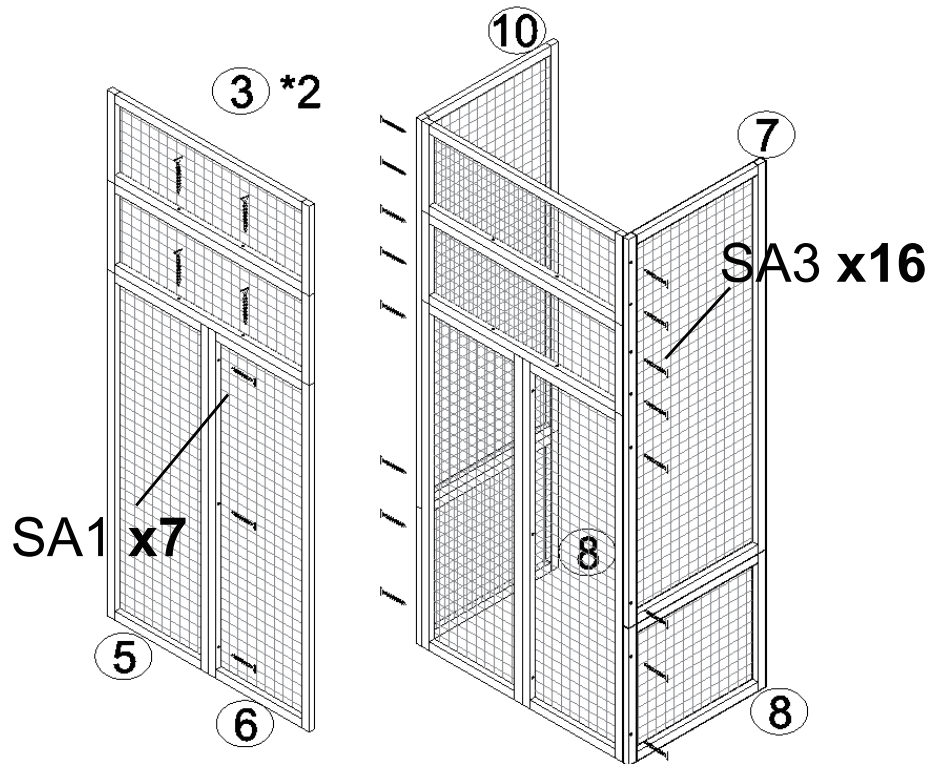

Please pay attention to the position of Panel 5 and Panel 6, and assemble them in strict accordance with the instructions.

STEP 7/ Paso 7

SA1 12PCS (Piezas)

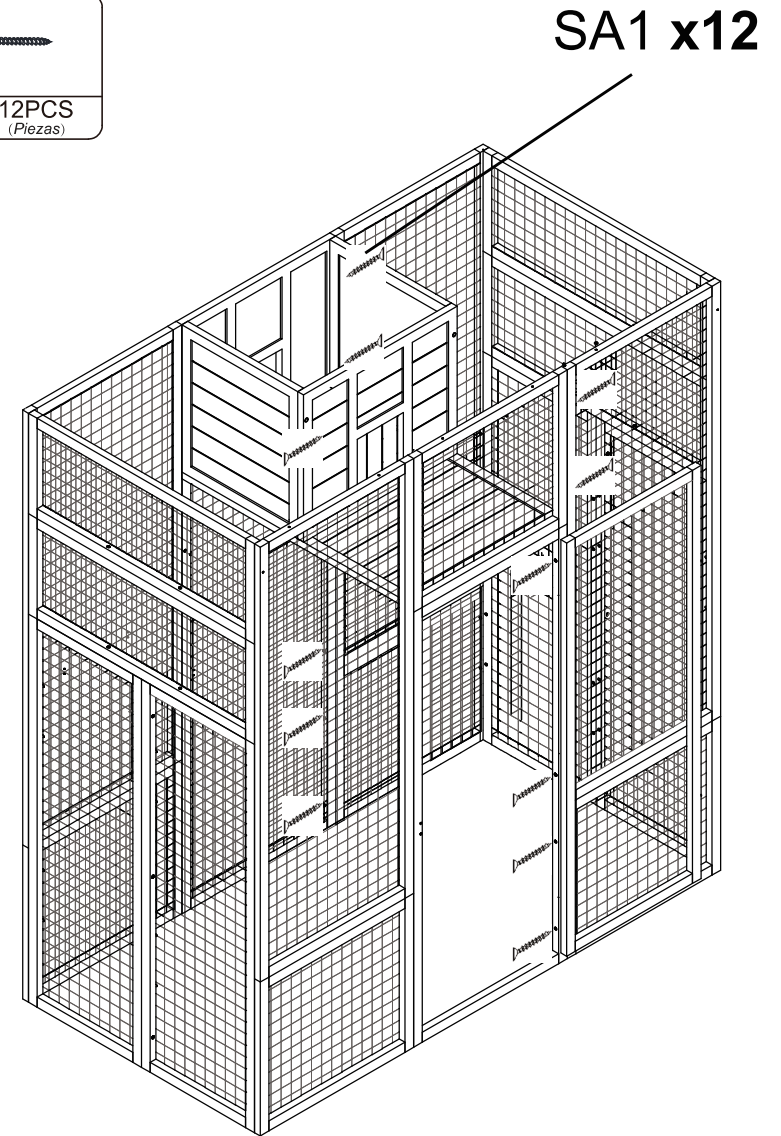

PRODUCT ASSEMBLY (Ensamblaje del Producto)

STEP 6/ Paso 6

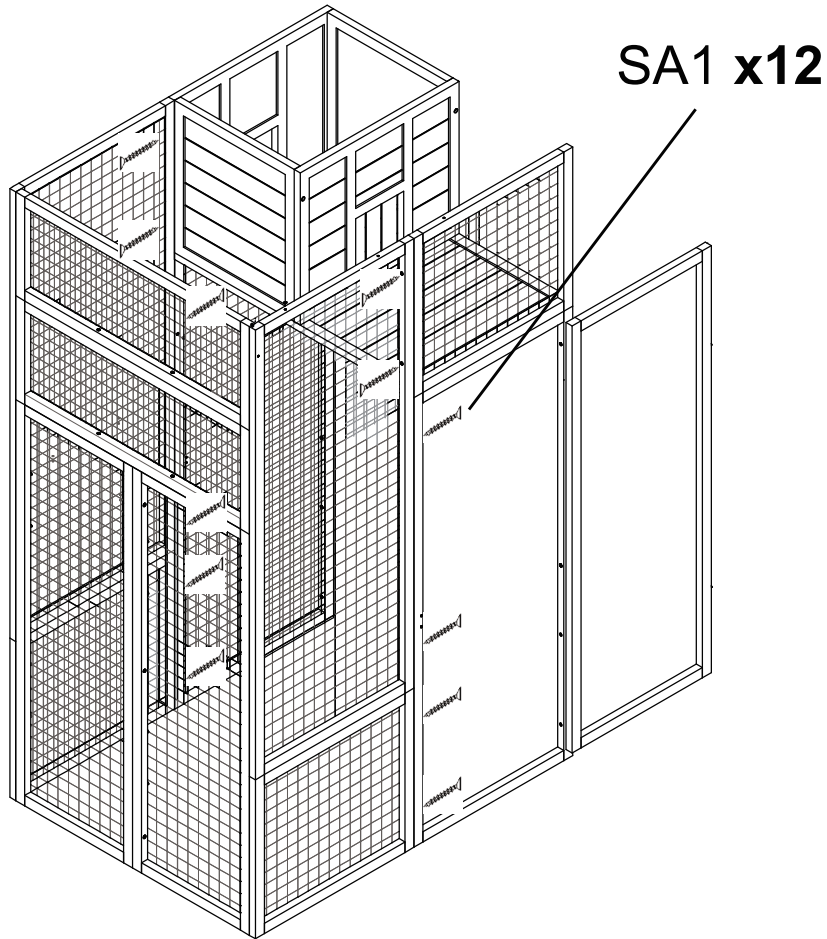
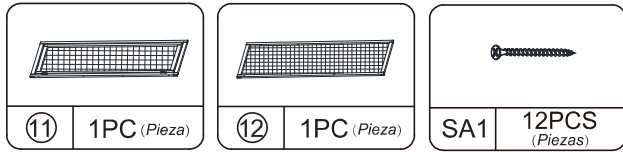

PRODUCT ASSEMBLY (Ensamblaje del Producto)

STEP 3/ Paso 3

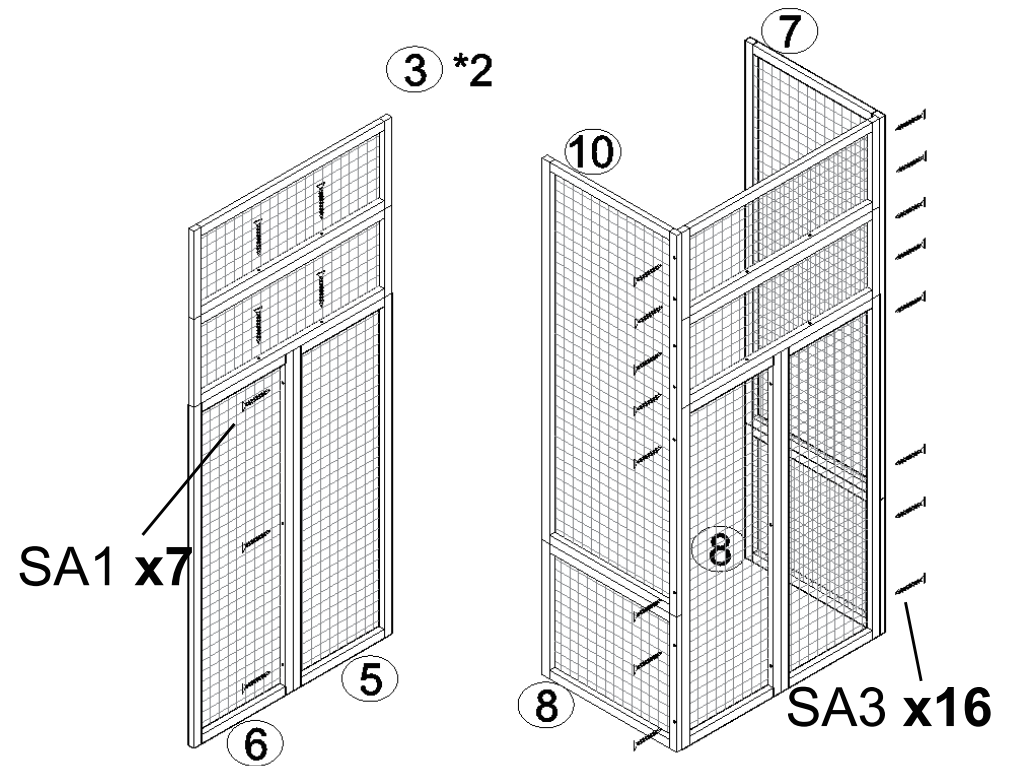
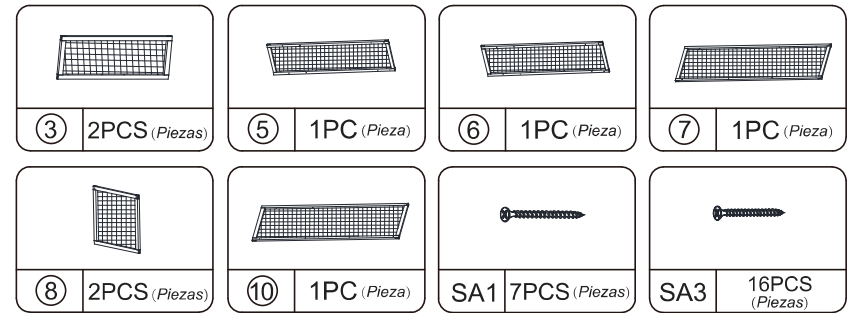

Please pay attention to the position of Panel 5 and Panel 6, and assemble them in strict accordance with the instructions.

STEP 4/ Paso 4

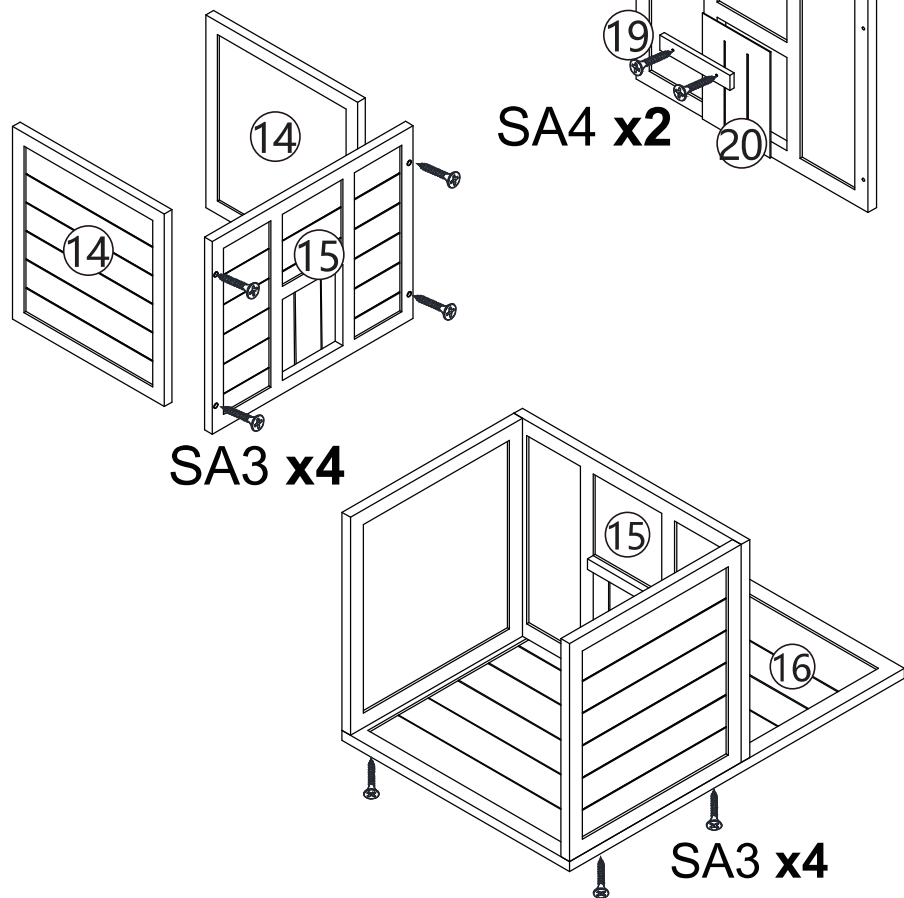
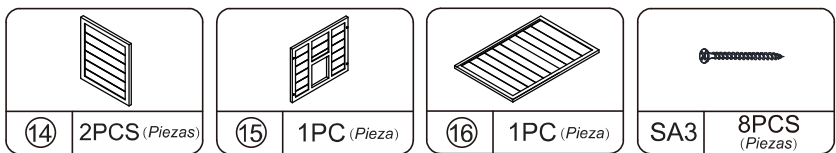

STEP 5/ Paso 5

