

Installation & Assembly

Important

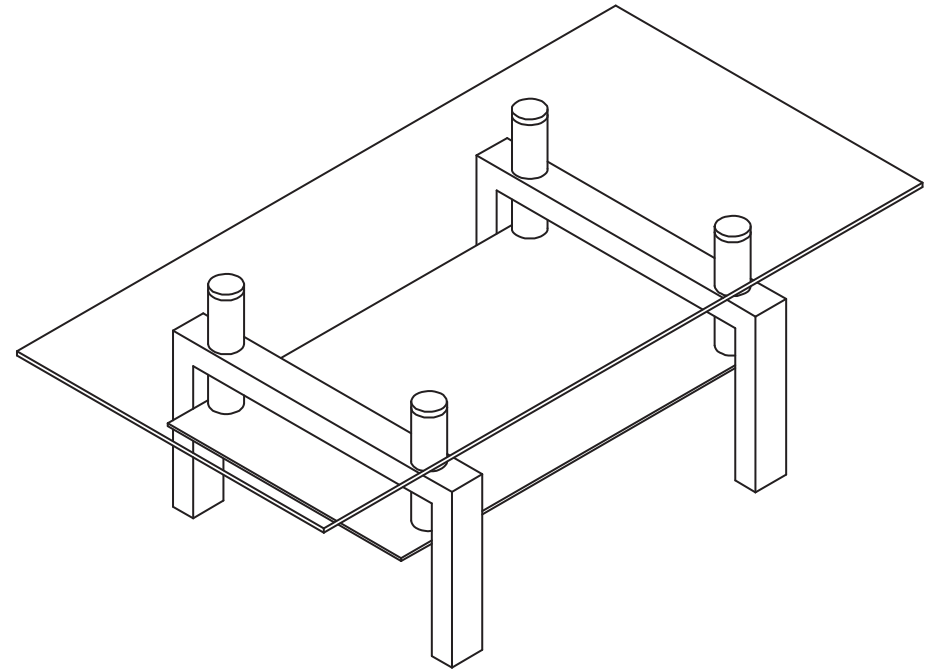



Please inspect all items carefully before assembling.
 If for any reason you need to return this item, you must return it in its original packaging.
Assembled items can not be returned.





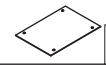

COMPONENTS LIST

Important Note:



- *Place all parts on a clean and smooth surface such as a rug or carpet to avoid the parts from being scratched.
- *Kindly follow the assembly instruction step by step.
- *Don't tighten all screws until the table is fully set-up.

1	Top Glass		x1
2	Mid+Bot Glass		x1
3	Tube#1		x2
A	Plastic washer		x4
B	Metal washer		x4
C	Nut		x4

4	Tube#2		x4
5	Tube#3		x4
6	Bolt		x4
D	Allen Key		x1
E	Plastic Spacer		x12

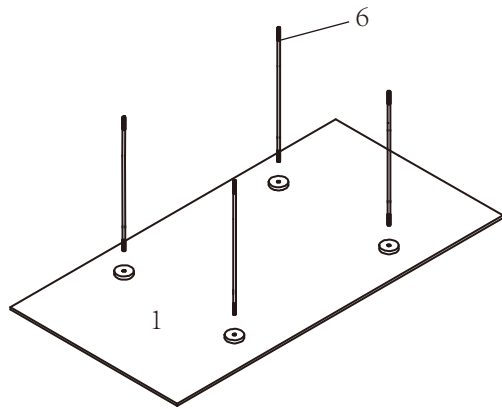

1

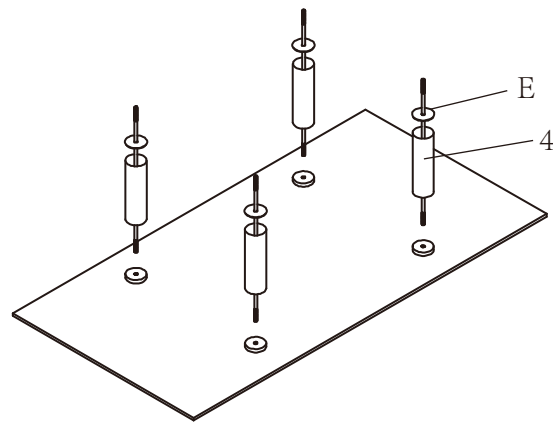

1	Top Glass		x1
6	Bolt		x4

2



4	Tube#2		x4
E	Plastic Spacer		x4

3

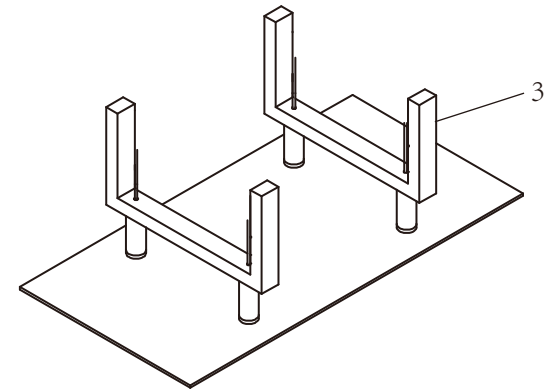

3	Tube#1		x2
---	--------	---	----

4

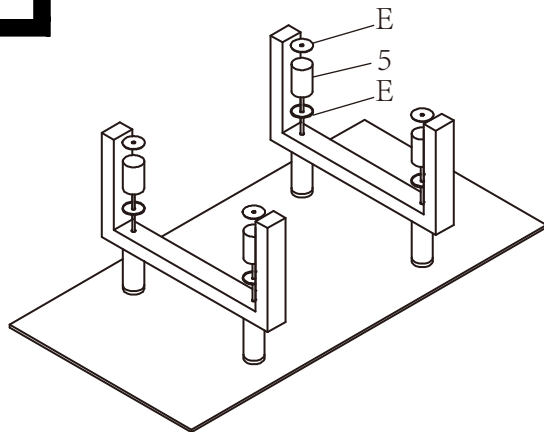

5	Tube#3		x4
E	Plastic Spacer		x8



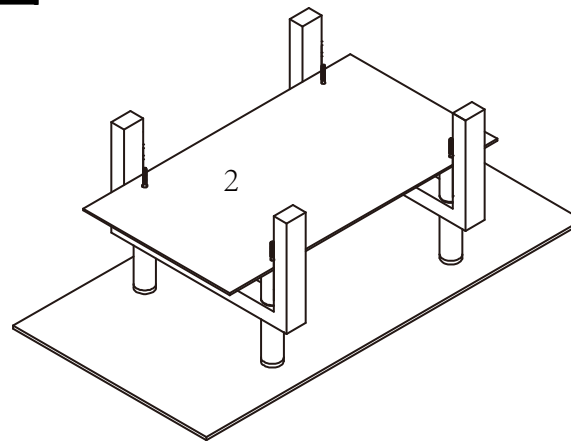

5

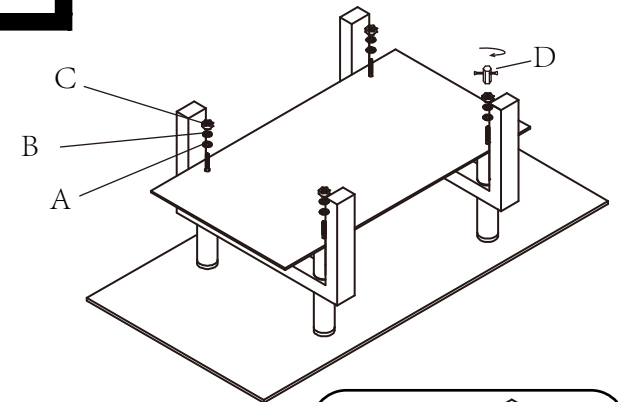

2	Mid+Bot Glass		x1
---	---------------	---	----

6



A	Plastic washer		x4
B	Metal washer		x4
C	Nut		x4
D	Allen Key		x1

