



ASSEMBLY INSTRUCTION - BM279003



Thank you for purchasing the quality product. Be sure to check all packing material carefully for small parts which may have come loose inside the carton during shipment. Separate, identify and count all parts and metal hardware. Compare with all parts list to be sure all parts are present. If any part(s) are missing or damaged, please contact your local furniture dealer. For efficient and speedy service, please indicate the model number and code letter of part(s) needed.

***** Do not fully tighten screws until fully assembled *****

PARTS LIST

NO	DESCRIPTION	SKETCH	QTY
A	DINING TABLE-TOP		1 Pcs
B	DINING TABLE - LEGS		4 Pcs

HARDWARE LIST

NO	DESCRIPTION	SKETCH	QTY
1	BOLT (Ø5/16*60MM)		12 Pcs
2	FLAT WASHER (Ø5/16*2MM)		12 Pcs
3	ALLEN KEY (M4)		1 Pcs

STEP 1

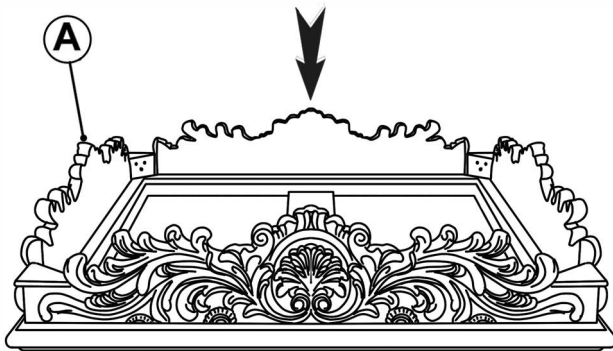

STEP 2

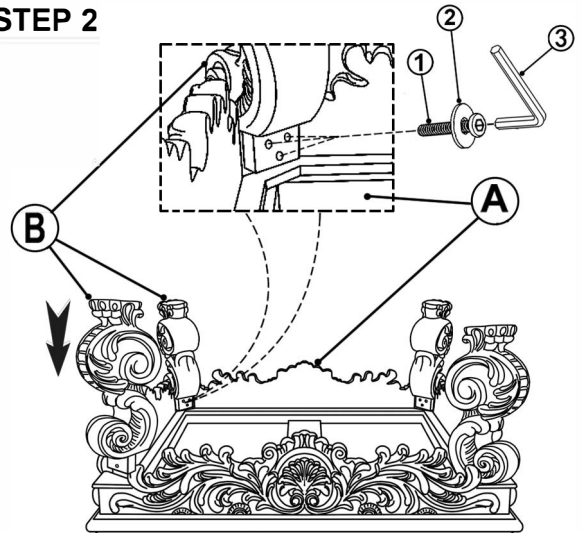

STEP 3

STAND IT UP

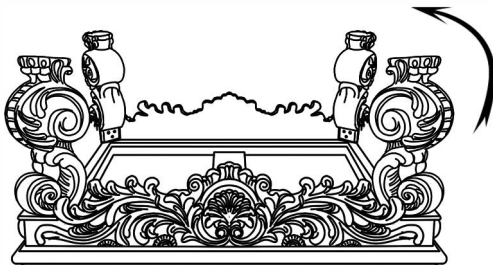

STEP 4



COMPLETED