



# INSTALLATION MANUAL

## Freestanding Bathtub

OFFICIAL WEBSITE: [WWW.MOKLEBABATH.COM](http://WWW.MOKLEBABATH.COM)

E-MAIL: [SALES@MOKLEBABATH.COM](mailto:SALES@MOKLEBABATH.COM)

MANUFACTURED BY ART BATH COMPANY INC

BATHTUB PICTURED MAY VARY SLIGHTLY DIFFERENT THAN THE ONE PURCHASED

FOR RESIDENTIAL USE ONLY IN US & CA

WARRANTY VOID OUTSIDE US & CA

REVISED 10/16

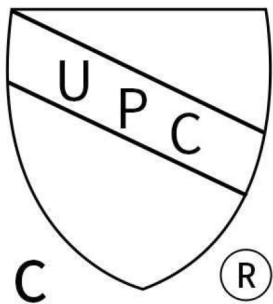

## BEFORE YOU BEGIN

- Please read these instructions carefully to familiarize yourself with the required tools, materials, and installation instructions. Follow the sections that pertain to your particular installation. Doing so will help you avoid costly mistakes. In addition to proper installation, please read all operating and safety instructions
- Please provide adequate space for the bath unit in accordance with the rough-in. Arrange the location of the drain in advance
- These instructions contain important care, cleaning, and warranty information

## COMPLIANCE INFORMATION

- Art Bath Company Inc only provides the bathtub. It is the buyer's or installer's responsibility to make sure that the bathtub and installation complies with local state, city, and regulatory laws. It is also the responsibility of the buyer or installer to ensure that the waste drain is made watertight with silicone sealant or caulking compound

## SAFETY

- Please use all necessary safety precautions when using the bathtub
- Bathtub may become slippery when wet and increase risk of fall or injury
- Use of handrails or handicap accommodations is highly recommended for seniors or those with disabilities
- Ensure small children are supervised when using the tub to prevent risk of drowning or injury
- Pets should not be left in the tub without proper supervision
- Under no circumstances is the manufacturer liable for bodily harm or injury stemming from accidental falls or misuse of our bathtub

## MAINTENANCE

- Most dirt will simply be washed off with mild soap and water
- **CAUTION:** Do not use any industrial strength cleaners or solvents to clean the bathtub surface. The surface will be damaged
- Only use calcium remover when cleaning chrome surfaces
- **CAUTION:** Avoid getting calcium remover on the bathtub surface

## REPAIR

- For Minor Scratches & Dulling: Use liquid polishing compound suitable for acrylic
- For Deep Scratches or Burns: Use very fine sandpaper (at least 1500 grit) in a circular motion covering an area wider than the scratch. Always wet the sandpaper with water before sanding. Repeat until the scratch is eliminated. Finally, polish the area with polishing compound to bring back its original shine. Use a soft cloth and a small amount of polish to buff the surface. Repeat the process as needed

# INSTALLATION REQUIREMENTS

## Tools Required



ADJUSTABLE  
PIPEWRENCH



ADJUSTABLE  
WRENCH



UTILITYKNIFE



PLIERS



TAPEMEASURE



LEVELER



SAFETYSHOES



SAFETYGLASSES



SCREWDRIVER

## Materials Required

- Plumbers Putty
- Wall Coverings (as necessary)
- Silicone Sealant/Caulking
- Gypsum Cement (optional)
- Construction Adhesive (optional)
- Nails
- Protective Covering for the Bathtub

INCLUDE PARTS	DESCRIPTION
	Flexible Tube
	Adapter
	Bathtub

### INSTALLATION NOTES

- Read the entire installation manual before beginning the installation. If installing a rim-mounted faucet (only on certain models), make sure there is no interference with the overflow drain before drilling any holes
- Position a protective covering or similar material in the bottom of the unit to protect the bathtub's surface from being scratched

### CLEARANCE REQUIREMENTS

- Measure the area where you intend to install the bathtub to ensure you have adequate space available for the installation

### SITE REQUIREMENTS

#### Sub-floor Preparation

- Check the flooring where the bathtub is going to be installed and make repairs as needed. Make sure the sub-floor is level. It is strongly recommended to prepare a waterproof layer for the sub-floor beforehand

## FAUCET INSTALLATION ON THE BATHTUB (OPTIONAL) INSTALLATION DU ROBINET SUR LA BAIGNOIRE (OPTIONNEL)

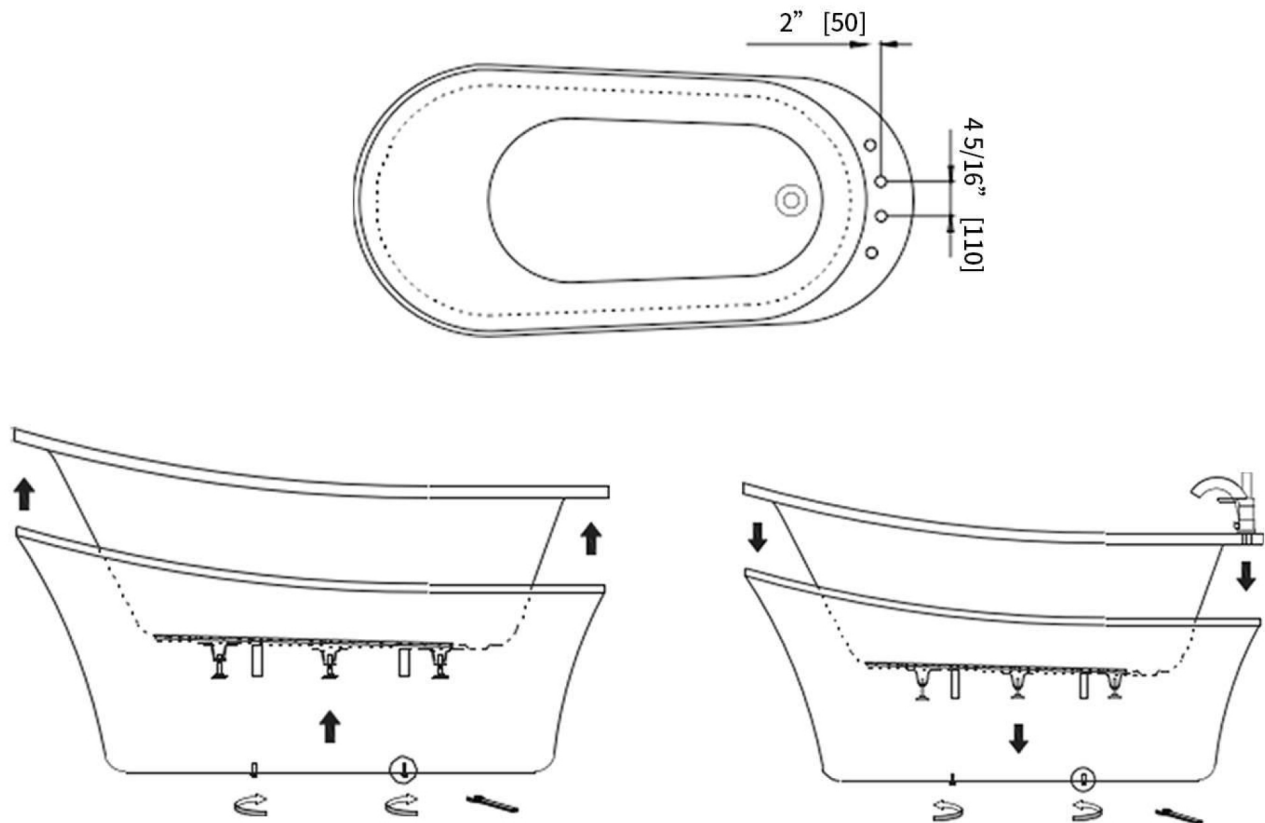

- Locate where you will drill the holes into the acrylic, and stick masking tape onto that area. This will prevent the acrylic from chipping
- Drill holes for the faucets on the bathtub at the desired location
- Unscrew the bolts at the bottom of the bathtub using an adjustable key. Then carefully take out the top of the tub and place it on a throw rug or other protective floor covering to prevent damage to the bath and the floor
- Install the faucets according to the faucets' manufacturer instructions. Then assemble the top of the bathtub with the skirt, and secure the bolts at the bottom as shown in the illustration

**Notes: Check all pipe connections to ensure no leakage occurs.**

# SPECIFICATION

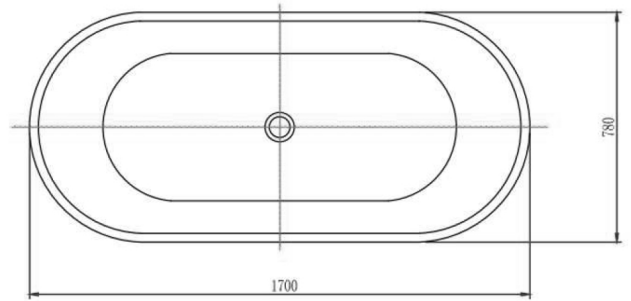
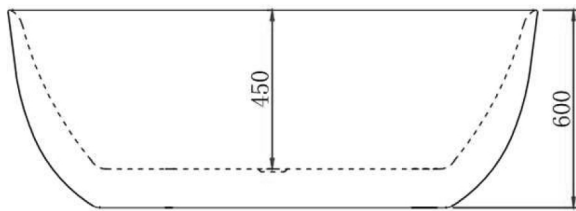
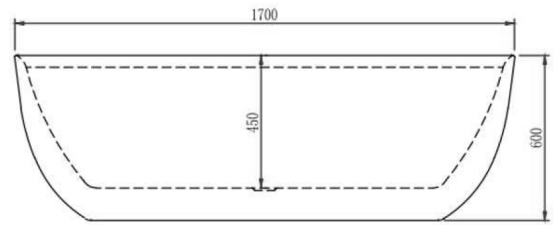
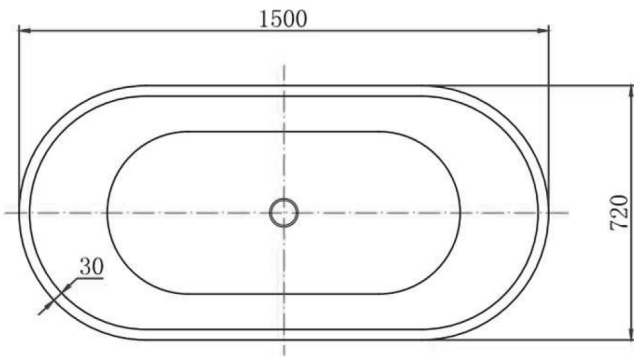

84572

84778

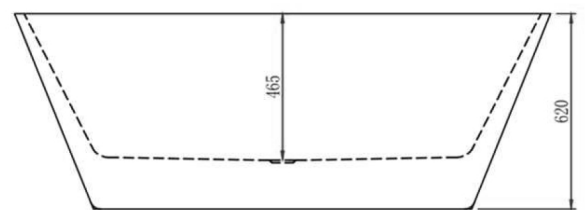
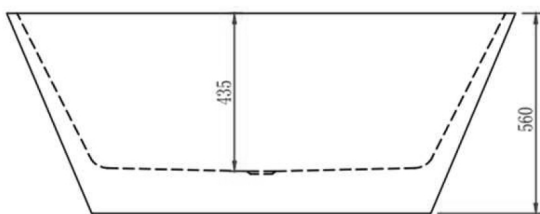
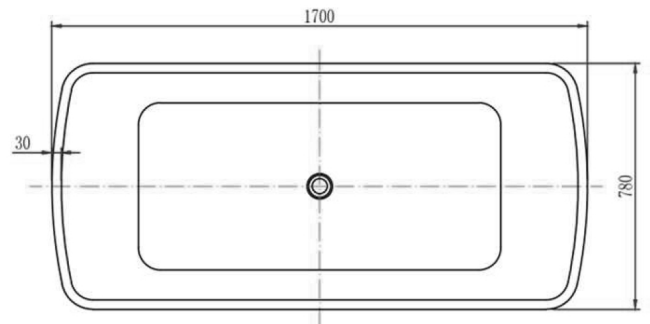
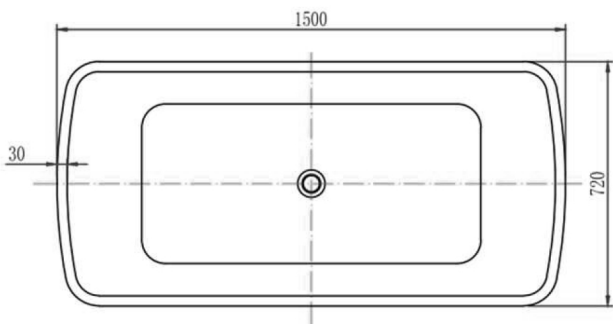

27572

27778

# SPECIFICATION

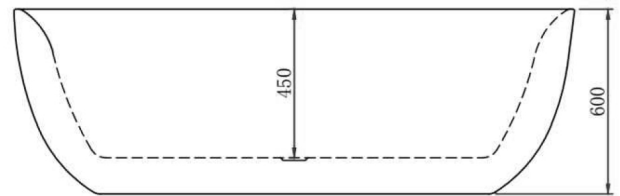
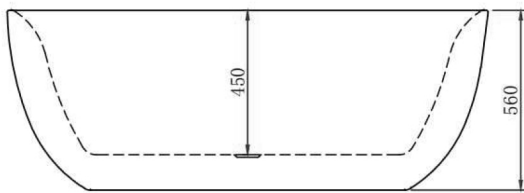
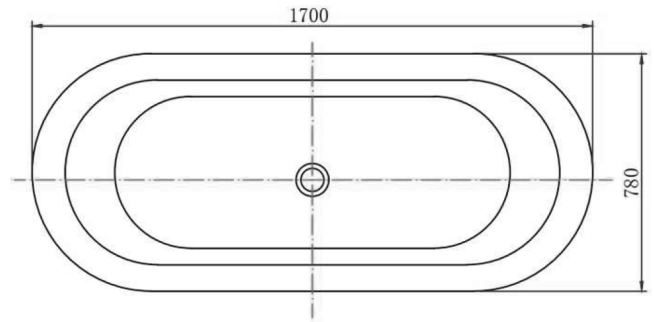
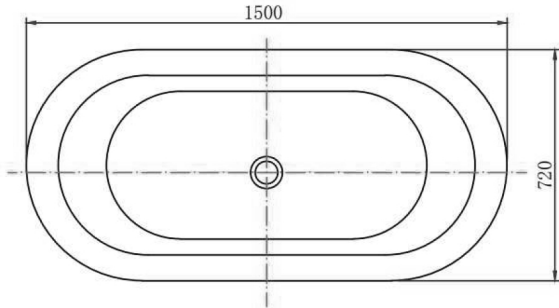

44572

44778

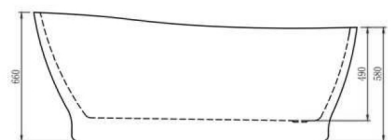
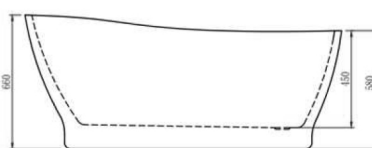
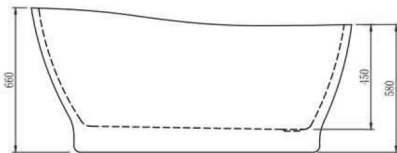
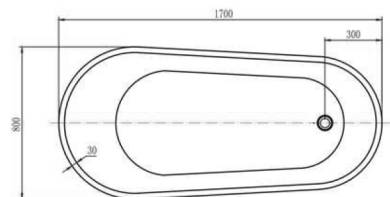
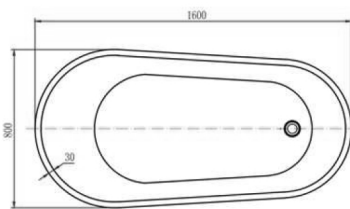
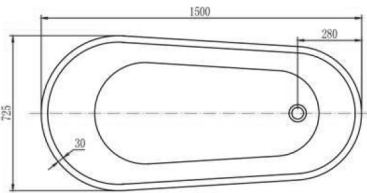

21572

21680

21785

# SPECIFICATION

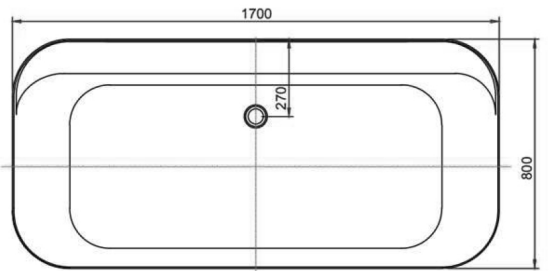
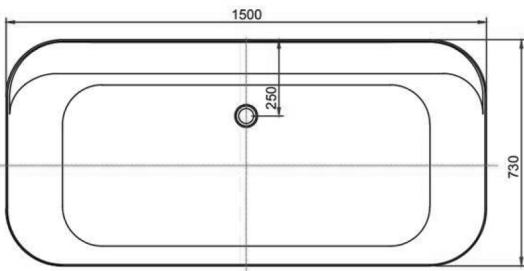
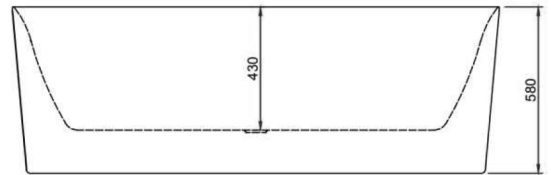
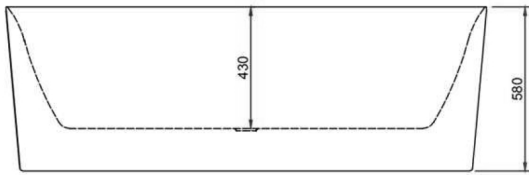

116573

116780

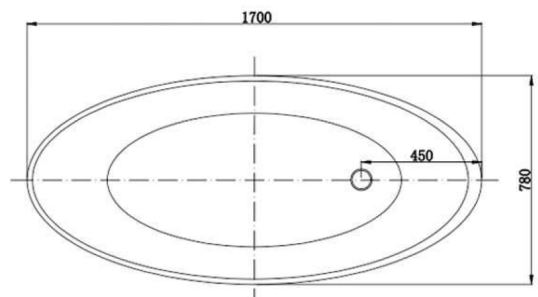
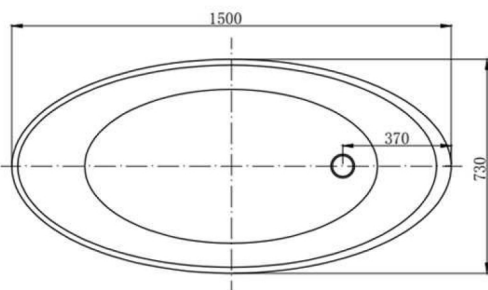
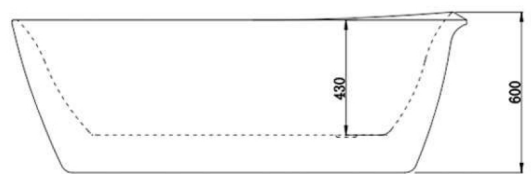
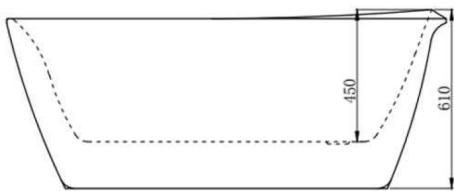

125573

125778

# SPECIFICATION

---

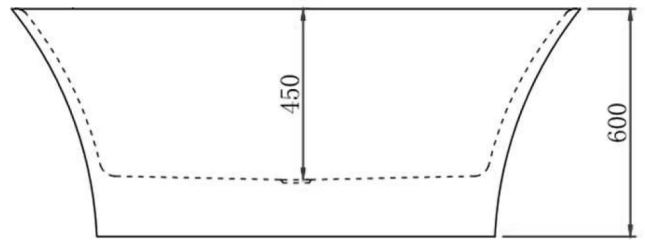
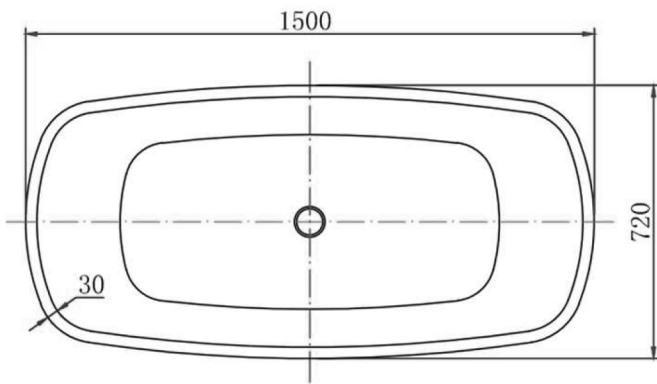

80572

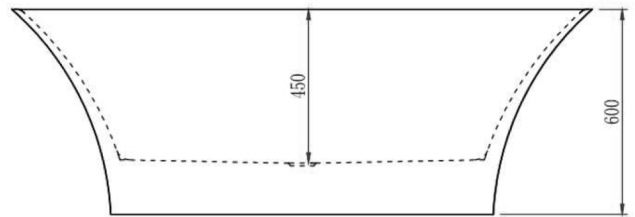
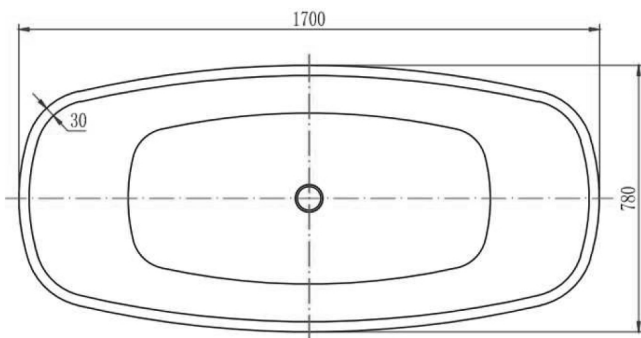

80778

# SPECIFICATION

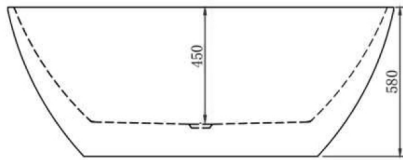
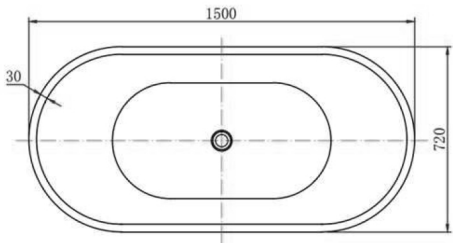

11572

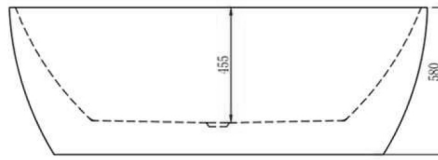
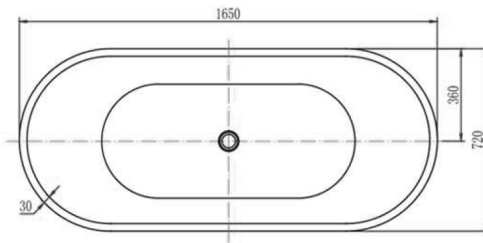

11672

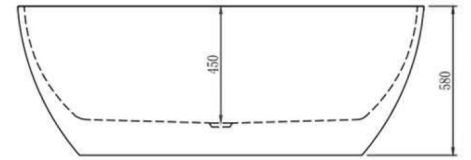
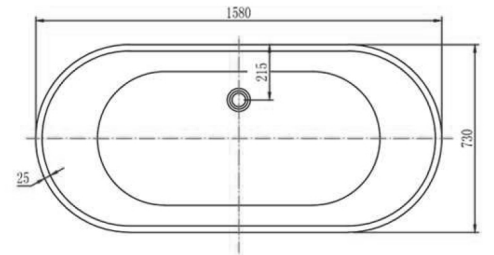

11673

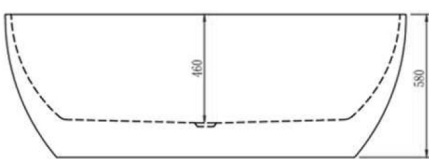
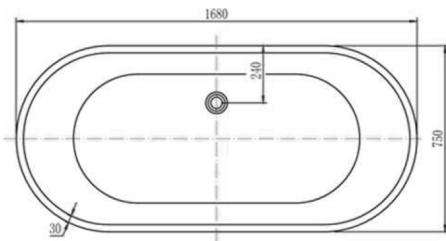

11775

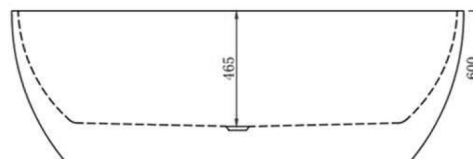
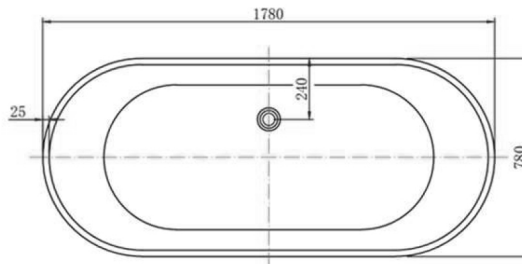

11878

# SPECIFICATION

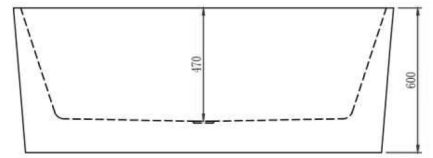
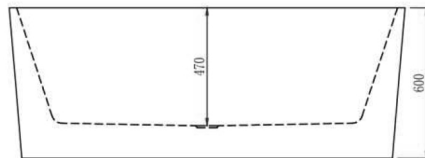
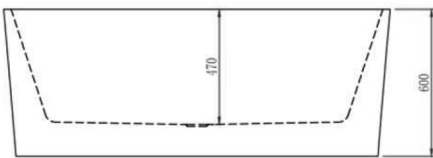
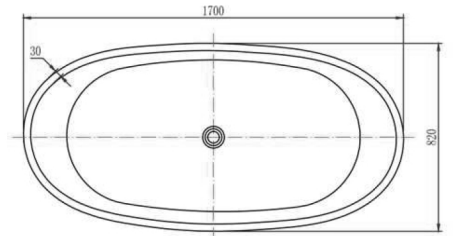
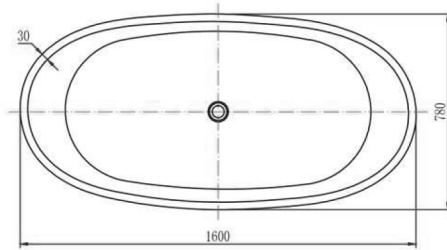
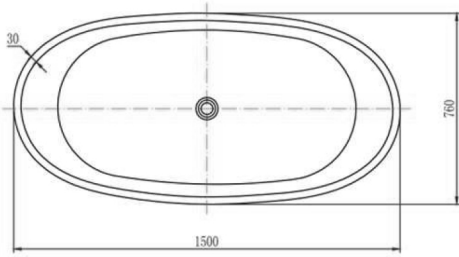

16576

16678

16782

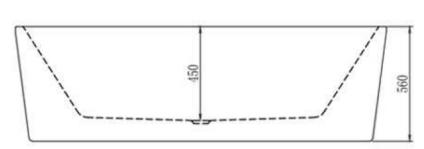
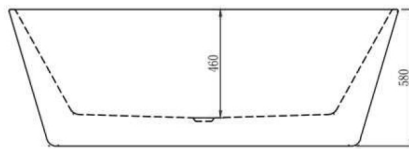
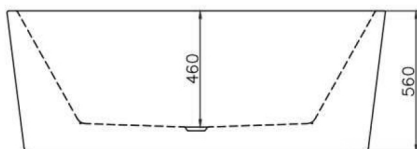
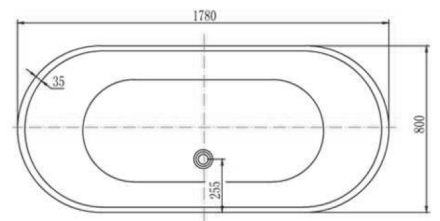
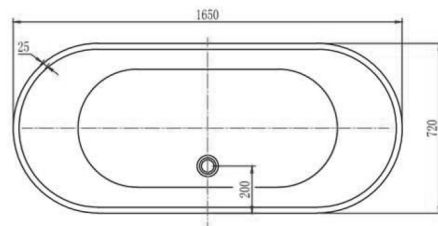
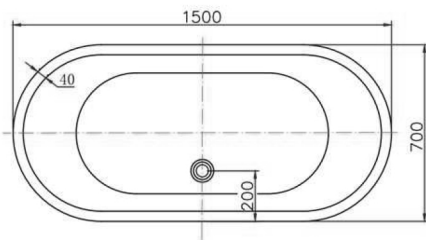

1581

1681

1881

# SPECIFICATION

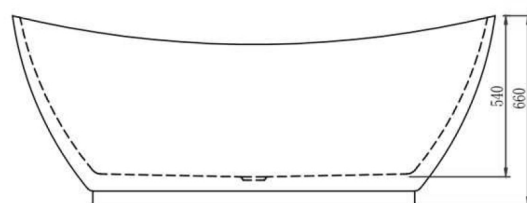
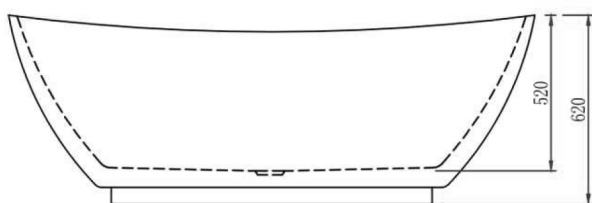
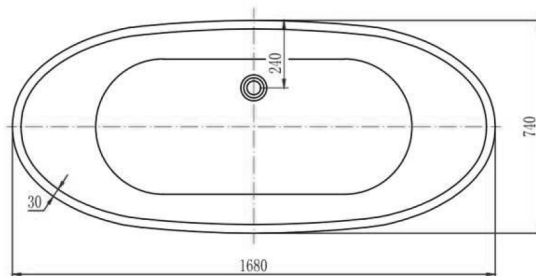
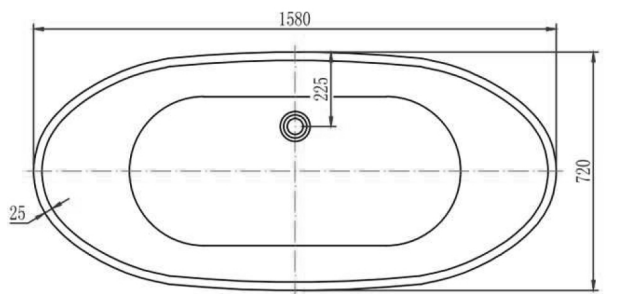

10672

10774

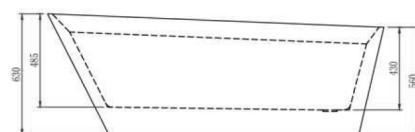
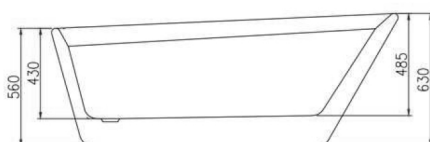
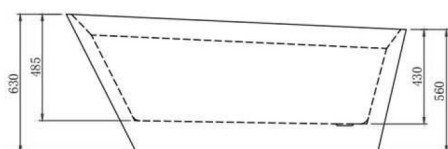
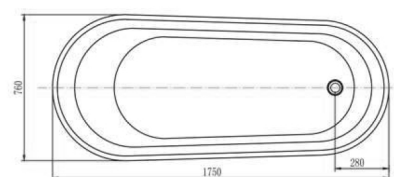
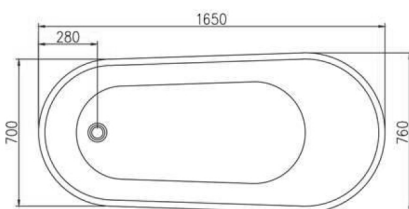
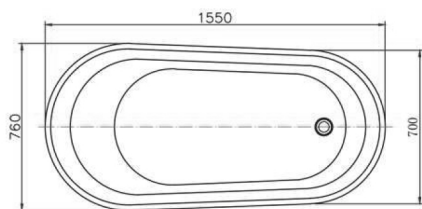

1506B

1606B

1706B

# SPECIFICATION

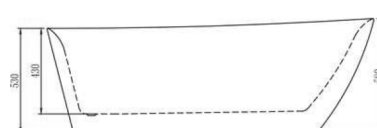
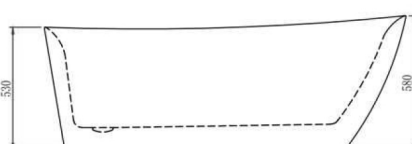
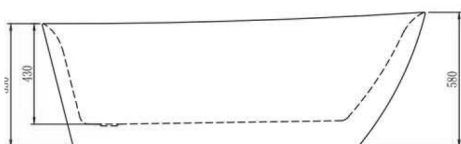
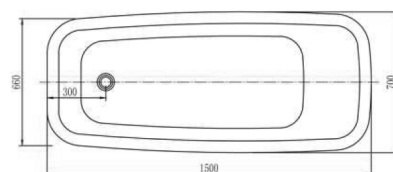
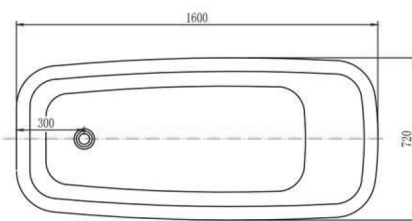
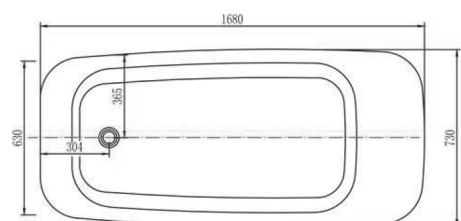

9773

9672

9570

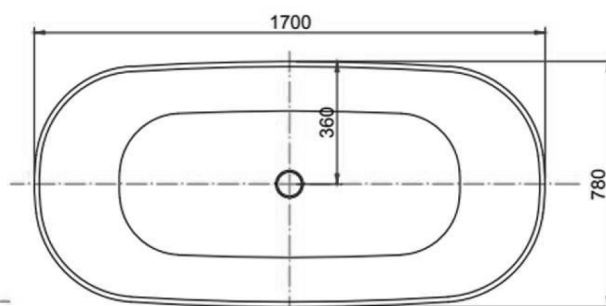
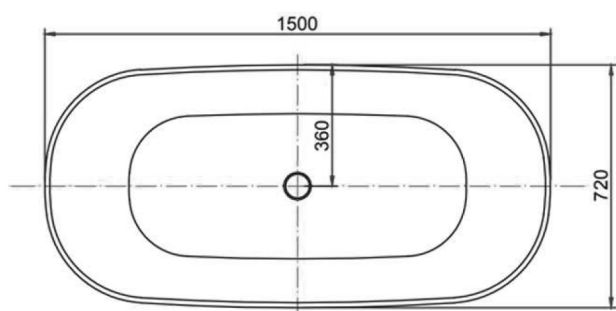
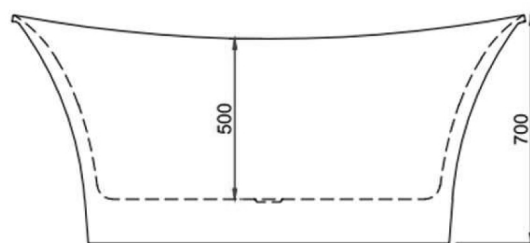
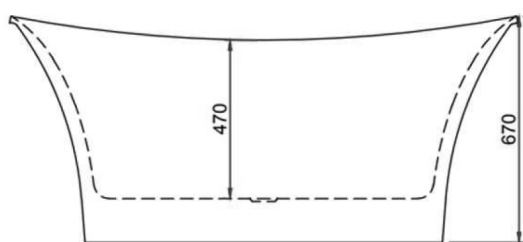

93572

93778

# SPECIFICATION

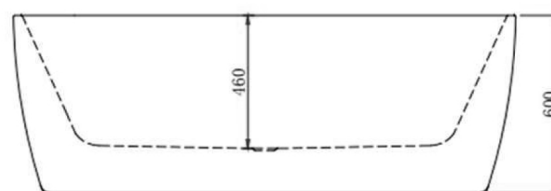
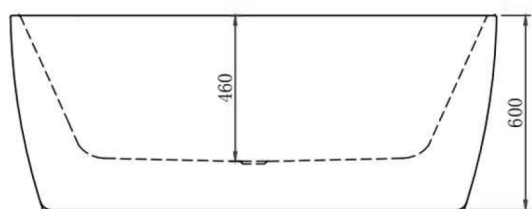
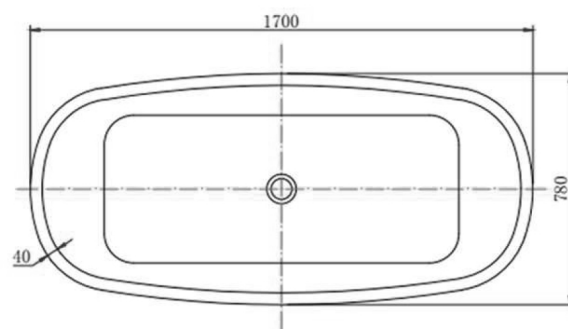
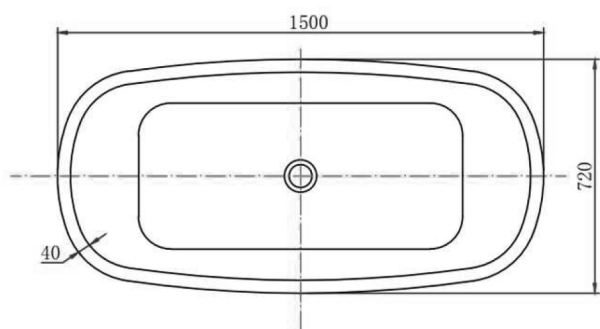

43572

43778

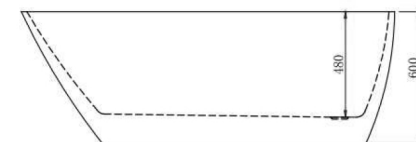
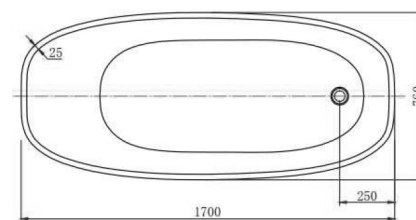
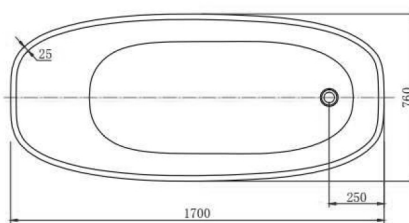
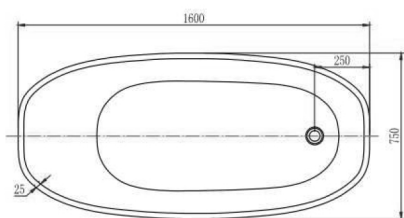

15575

15675

15776

# INSTALLATION (Option #1)

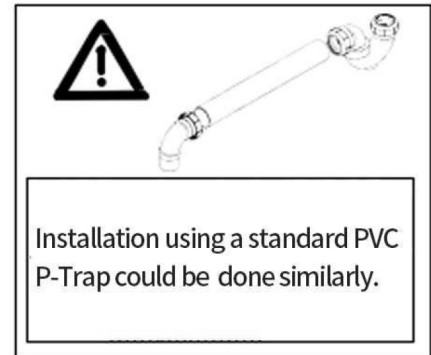
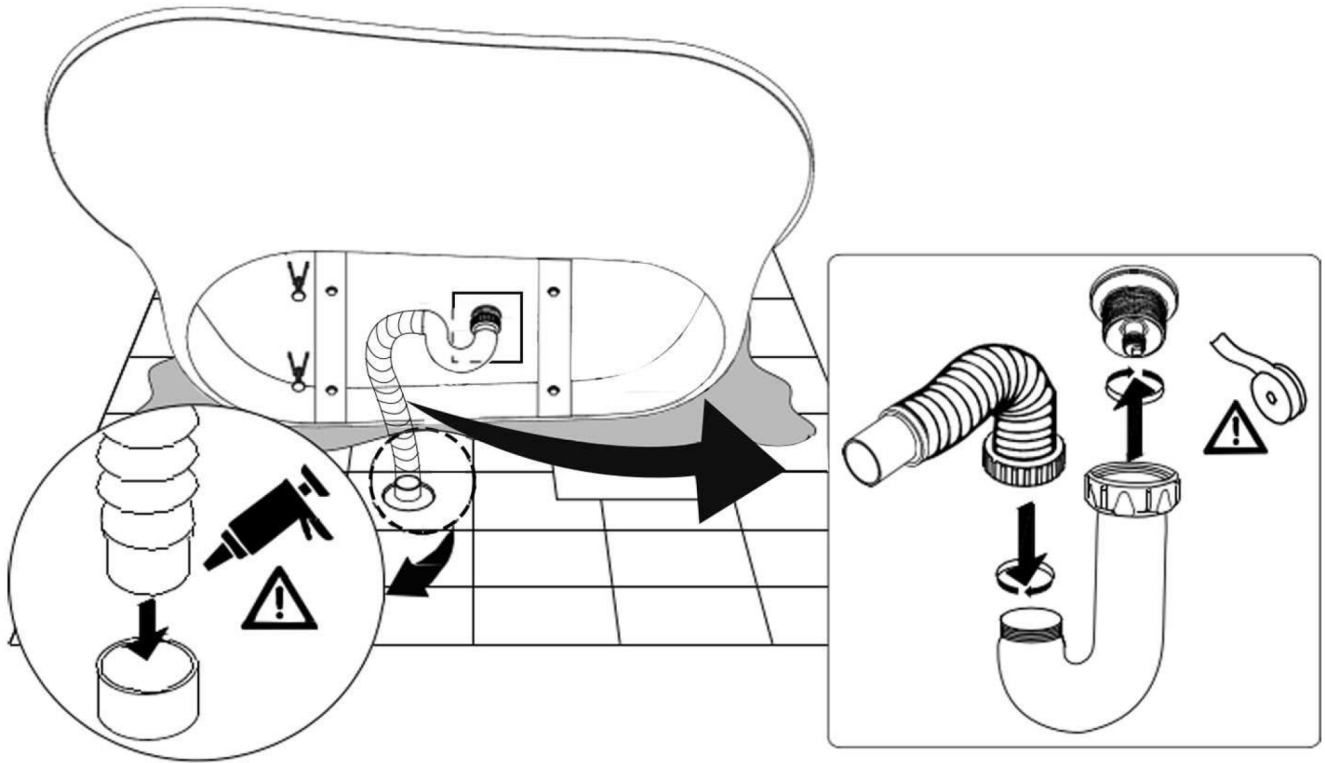

## Option #1

- Screw the supplied Adapter to the preinstalled bathtub drain. Use Teflon tape and/or sealant
- Connect the P-Trap to the Adapter using PVC pipe sealant to adequately join the two parts
- Then, as shown in the illustration, connect the P-Trap to the Flexible Tube
- Connect the Flexible Tube to your existing floor drain as illustrated, using PVC pipe sealant to join the parts together

# SECURING THE BATHTUB

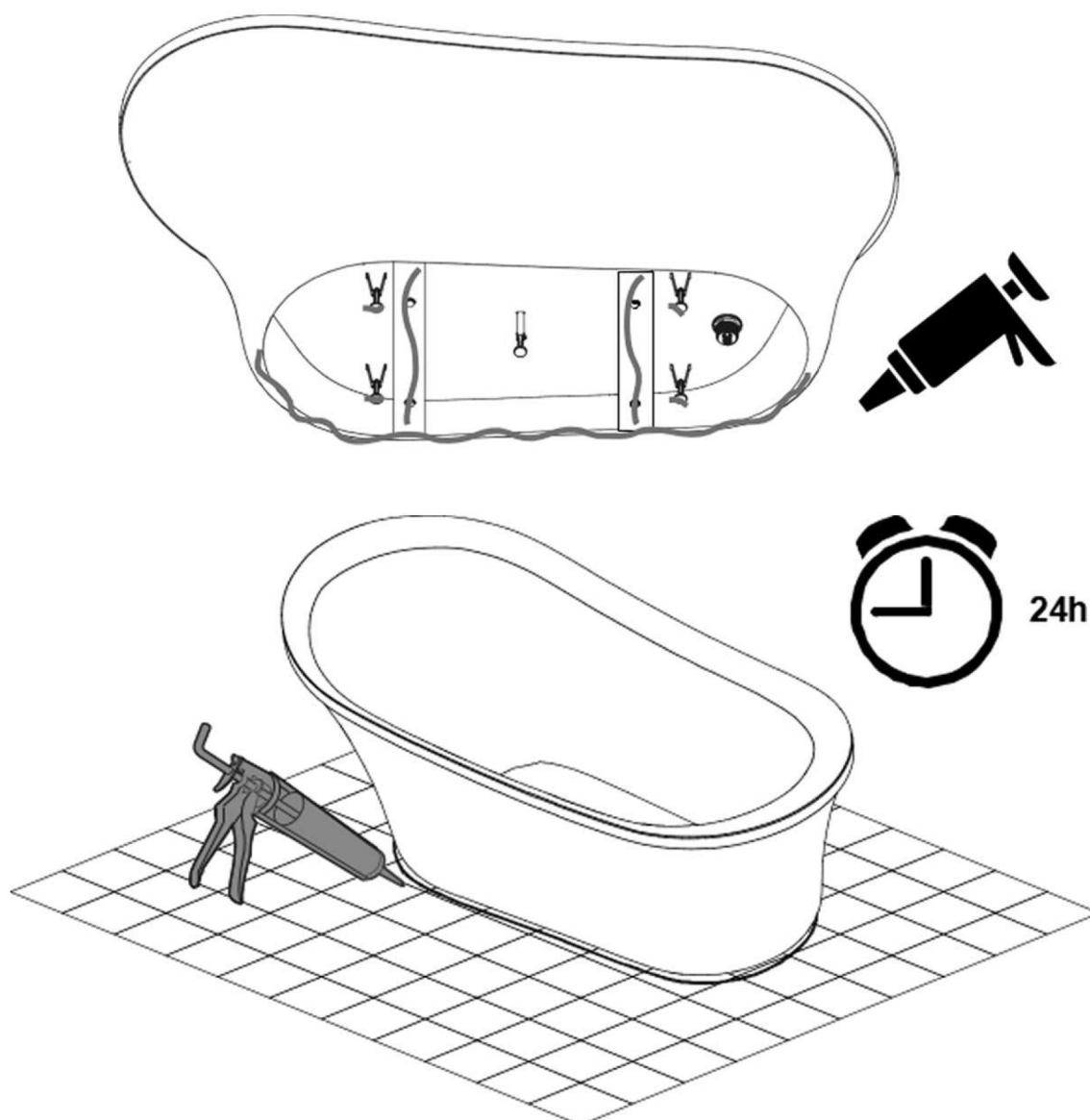

**BEFORE FIXING THE BATHTUB TO THE FLOOR, MAKE SURE YOU HAVE INSTALLED YOUR FAUCET(IF APPLICABLE) AND THAT YOU HAVE CHECKED FOR LEAKS**

- Test for leak by filling up the tub and let it drain. Then check all plumbing connections for leaks
- Fix the bathtub to the floor by applying a strong Tub &Tile Adhesive under each edges of the tub that will be in contact with the floor: The rim, the lateral bars and the feet
- Finally, for a professional finish, draw a bead of silicone around the base
- Let it dry for 24 hours

## RETURNS & WARRANTY

We thank you for your purchase. If you are not satisfied with your purchase or have an issue with our product, please kindly let us know. Our full returns policy is outlined below. Carefully read over our terms before contacting us. If you have questions, our customer service team can be reached: [sales@moklebabath.com](mailto:sales@moklebabath.com).

For 1-3 years from the date of purchase, when this major appliance is operated and maintained according to instructions attached to or furnished with the product, Moklebabath.com will supply factory specified replacement parts for free if needed. This limited warranty is valid only in the United States or Canada and applies only when the major appliance is used in the country where it was purchased. Outside the United States and Canada, this limited warranty will be voided if it is used outside the United States and Canada. Proof of original purchase date is required to obtain service under this limited warranty

## WARRANTY EXCLUSIONS

The included warranty is null/void and does not cover the following conditions:

1. Service calls to correct the installation of your major appliance, to instruct you on how to use your major appliance, to replace or repair house fuses, or to correct house wiring or plumbing.
2. Service calls to repair or replace appliance light bulbs, air filters or water filters. Consumable parts are excluded from warranty coverage.
3. Repairs when your major appliance is used for other than normal, single-family household use or when it is used in a manner that is contrary to published user or operator instructions and/or installation instructions.
4. Damage resulting from accident, alteration, misuse, abuse, fire, flood, acts of God, improper installation, installation not in accordance with electrical or plumbing codes, or use of consumables or cleaning products not approved by us.
5. Cosmetic damage, including scratches, dents, chips or other damage to the finish of your major appliance, unless such damage results from defects in materials or workmanship and is reported to us within 30 days from the date of purchase.
6. Any food loss due to refrigerator or freezer product failures.
7. Costs associated with the removal from your home of your major appliance for repairs. This major appliance is designed to be repaired in the home and only in-home service is covered by this warranty.
8. Repairs to parts or systems resulting from unauthorized modifications made to the appliance.
9. The removal and reinstallation of your major appliance if it is installed in an inaccessible location or is not installed in accordance with published installation instructions.
10. Major appliances with original model/serial numbers that have been removed, altered or cannot be easily determined. This warranty is void if the factory applied serial number has been altered or removed from your major appliance. The cost of repair or replacement under these excluded circumstances shall be borne by the customer.

## RETURNS, DAMAGES, MISSING PARTS

### Ground Shipments – Range Hoods, Shower Heads/Wands, Sinks, Tub Fillers

We accept all returns within 30 days with return shipping to be paid by the customer if the item was:

Deemed unsuitable  
the wrong size  
purchased but not used  
an accidental purchase  
buyer's remorse

### Resolution Process for Damages or Missing Items (Ground Shipments)

Customer provides images of damage (mandatory)

Customer notifies us (Moklebabath.com) for missing parts or items

We send a replacement unit (discretionary)

We send replacement parts

Customer is provided a new tracking number for the replacement or parts shipped via Ground shipping or Parcel

### Freight Shipments – Bathtubs Oversized Range Hoods

All bathtubs will ship via freight. Due to the large size and weight, please allow approximately 2 weeks for the item to arrive. If you have received a freight shipment, please kindly:

Inspect for damages (ex: cracks, chips, etc.)

Inspect for missing parts or items part of a bundle

### DISCLAIMER OF IMPLIED WARRANTIES: LIMITATION OF REMEDIES

CUSTOMER'S SOLE AND EXCLUSIVE REMEDY UNDER THIS LIMITED WARRANTY SHALL BE PRODUCT REPAIR AS PROVIDED HEREIN. IMPLIED WARRANTIES, INCLUDING WARRANTIES OF MERCHANTABILITY OR FITNESS FOR A PARTICULAR PURPOSE, ARE LIMITED TO ONE YEAR OR THE SHORTEST PERIOD ALLOWED BY LAW. MOKLEBABATH.COM SHALL NOT BE LIABLE FOR INCIDENTAL OR CONSEQUENTIAL DAMAGES. SOME STATES AND PROVINCES DO NOT ALLOW THE EXCLUSION OR LIMITATION OF INCIDENTAL OR CONSEQUENTIAL DAMAGES, OR LIMITATIONS ON THE DURATION OF IMPLIED WARRANTIES OF MERCHANTABILITY OR FITNESS, SO THESE EXCLUSIONS OR LIMITATIONS MAY NOT APPLY TO YOU. THIS WARRANTY GIVES YOU SPECIFIC LEGAL RIGHTS, AND YOU MAY ALSO HAVE OTHER RIGHTS WHICH VARY FROM STATE TO STATE OR PROVINCE TO PROVINCE.

## Resolution Process for Damages or Missing Items (Freight Shipments)

Customer provides images of damage (mandatory)

Customer notifies us (Moklebabath.com) for missing parts or items

We send a replacement unit (discretionary)

We send replacement parts

Customer is provided a new tracking number via our 3rd party LTL carrier for the replacement or parts

If the customer contacts us after the 30-day window for a return, ShopRangeHoods.com will require a 15-40% restocking fee to be applied to the return depending on the condition of the item and the number of days passed the standard 30-day window.

If shipping damage is noticeable upon arrival, please immediately reject the package, take pictures of the damages, and contact customer support for assistance.

If the item is delivered and arrived damaged, we will either send a replacement and take back the damaged item, or send parts to repair the item depending on the severity of the damage. A full replacement will be issued only under our discretion. Under certain authorized vendors who carry our products, shipping damages that require a full replacement will require contacting the seller and not Moklebabath.com.

All shipping damages must be reported within 30 days of delivery. Missing or lost items must be reported within 7 days of delivery.

The customer must also notify the local authorities to obtain a police report if the tracking information shows the item as being delivered, but not received. A replacement part or unit will be shipped out only if these rules are met. After the 30-day window for damaged items or 7 days for lost and missing packages, Moklebabath.com reserves the right to not ship replacement parts or complete units. No exceptions will be made and we will not be held responsible.

## MANUFACTURER'S WARRANTY

Moklebabath.com provides a 3-year limited parts warranty for all range hoods, and a 1-year limited parts warranty for all bathtubs, tub filters, kitchen sinks, shower heads, shower wands, and shower panels. Under this warranty, you (the customer), is entitled to replacement parts at no cost to repair and restore functionality if any part of the product were to fail. No labor is provided. Certain consumables that are not covered under this warranty include:

Lights (halogen and LEDs)  
Carbon Filters  
Mesh or Baffle Filters  
Ducting

The above parts are guaranteed to last one year beginning from the date of purchase. If they fail prematurely or are defective within 1 year of purchase, Moklebabath.com will replace them at no charge.

If a main unit or complete replacement has to be sent, Moklebabath.com will require that the customer pay for shipping. Shipping for parts are free under the warranty period.