

United
States
of
America

To Promote the Progress



of Science and Useful Arts

The Director

of the United States Patent and Trademark Office has received an application for a patent for a new and useful invention. The title and description of the invention are enclosed. The requirements of law have been complied with, and it has been determined that a patent on the invention shall be granted under the law.

Therefore, this United States

Patent

grants to the person(s) having title to this patent the right to exclude others from making, using, offering for sale, or selling the invention throughout the United States of America or importing the invention into the United States of America, and if the invention is a process, of the right to exclude others from using, offering for sale or selling throughout the United States of America, products made by that process, for the term set forth in 35 U.S.C. 154(a)(2) or (c)(1), subject to the payment of maintenance fees as provided by 35 U.S.C. 41(b). See the Maintenance Fee Notice on the inside of the cover.

Donna H. Hull

Performing the Functions and Duties of the
Under Secretary of Commerce for Intellectual Property and
Director of the United States Patent and Trademark Office



US00D934576S

(12) **United States Design Patent** (10) **Patent No.:** **US D934,576 S**
Liu (45) **Date of Patent:** **** Nov. 2, 2021**

(54) **MIRROR**

FOREIGN PATENT DOCUMENTS

(71) Applicant: **Shenzhen JianYuanDa Mirror Technology Co., Ltd.**, Shenzhen (CN)

EM 008142772-0001 * 8/2020
GB 9008142772-0001 * 8/2020

(72) Inventor: **Changwei Liu**, Shenzhen (CN)

OTHER PUBLICATIONS

(**) Term: **15 Years**

(21) Appl. No.: **29/746,639**

(22) Filed: **Aug. 14, 2020**

(51) **LOC (13) Cl.** **06-07**

(52) **U.S. Cl.**
USPC **D6/300**

(58) **Field of Classification Search**

USPC D6/300, 301, 302, 303, 304, 307, 308,
D6/309, 310, 311, 312, 313, 314;
D28/64.1-64.7; D14/336, 341, 371, 372,
D14/374, 381, 382, 448, 450
CPC A45D 42/00; A45D 42/10; A45D 42/16;
A45D 42/20; A45D 42/24; A47G 1/00;
A47G 1/02; A47G 1/04; A47G 1/0622;
B60J 3/0282

See application file for complete search history.

Fascinate Rechargeable Lighted Makeup Mirror [online], [site visited Sep. 8, 2021]. Available from internet, URL: <https://www.amazon.ca/FASCINATE-Rechargeable-Dimmable-Portable-Illuminated/dp/B088F832WH/ref=sr_1_1?dchild=1&keywords=B088F832WH&qid=1631136519&sr=8-1> (Year: 2020).
Makeup Mirrors rectangle [online], [site visited Sep. 8, 2021]. Available from internet, URL: <https://jianyunda.en.alibaba.com/product/1600112956693-827866156/Makeup_Mirrors_rectangle_3_color_compact_lighted_travel_makeup_mirror_for_cosmetic.html?spm=a2700.shop_index.3973.1.495371adaKICxX> (Year: 2021).*

* cited by examiner

Primary Examiner — Cynthia Ramirez
Assistant Examiner — Xavier Marti-Santos
(74) *Attorney, Agent, or Firm* — Novoclaims Patent Services LLC; Mei Lin Wong

(57) **CLAIM**

The ornamental design for a mirror, as shown and described.

DESCRIPTION

FIG. 1 is a perspective view of a mirror, showing my new design;
FIG. 2 is rear perspective view thereof;
FIG. 3 is a front view thereof;
FIG. 4 is a rear view thereof;
FIG. 5 is a left side view thereof;
FIG. 6 is a right side view thereof;
FIG. 7 is a top view thereof; and,
FIG. 8 is a bottom view thereof.
The broken lines in the figures are for the purpose of illustrating portions of the mirror, which form no part of the claimed design.

(56) **References Cited**

U.S. PATENT DOCUMENTS

D260,305 S * 8/1981 MacGregor D28/83
D282,024 S * 1/1986 Muranen D6/300
D309,986 S * 8/1990 Sakai D6/308
D313,126 S * 12/1990 Ratslaff D6/308
D466,115 S * 11/2002 Hawkins D14/341
D483,575 S * 12/2003 Chan D6/310
D846,805 S * 4/2019 Kaiser D28/64.2
D866,988 S * 11/2019 Shaffer D6/300
D882,281 S * 4/2020 Park D6/310
D891,790 S * 8/2020 Liu D6/301
D905,445 S * 12/2020 Yang D6/310
D907,035 S * 1/2021 Kim D14/341
D925,239 S * 7/2021 Cai D6/312

1 Claim, 8 Drawing Sheets

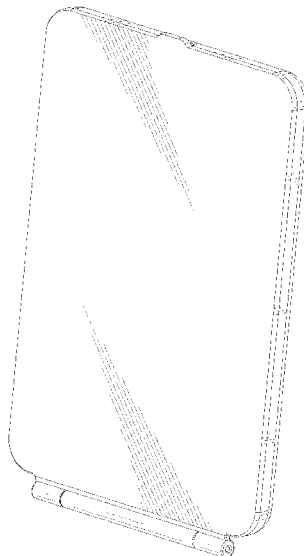

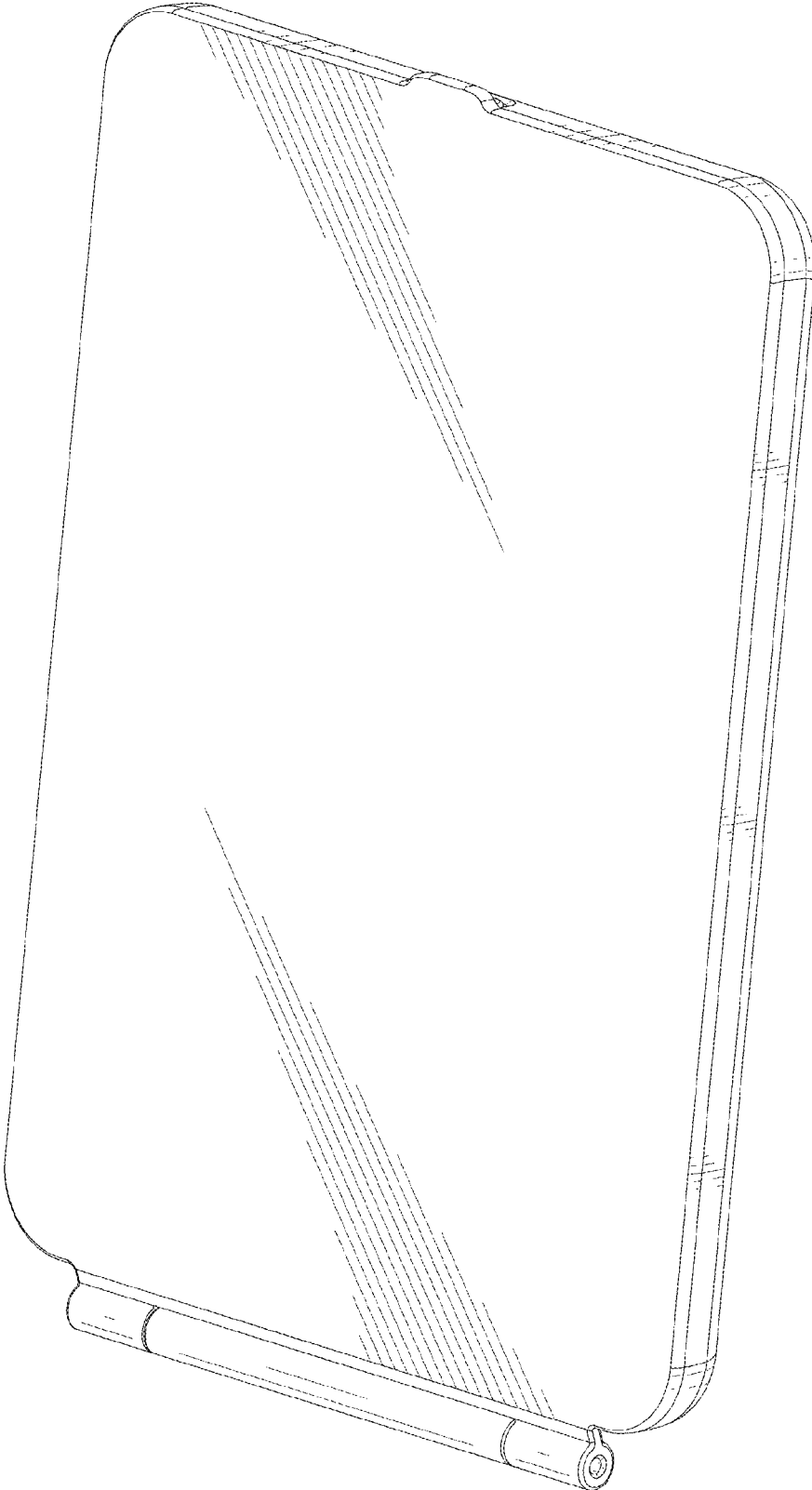

FIG.1

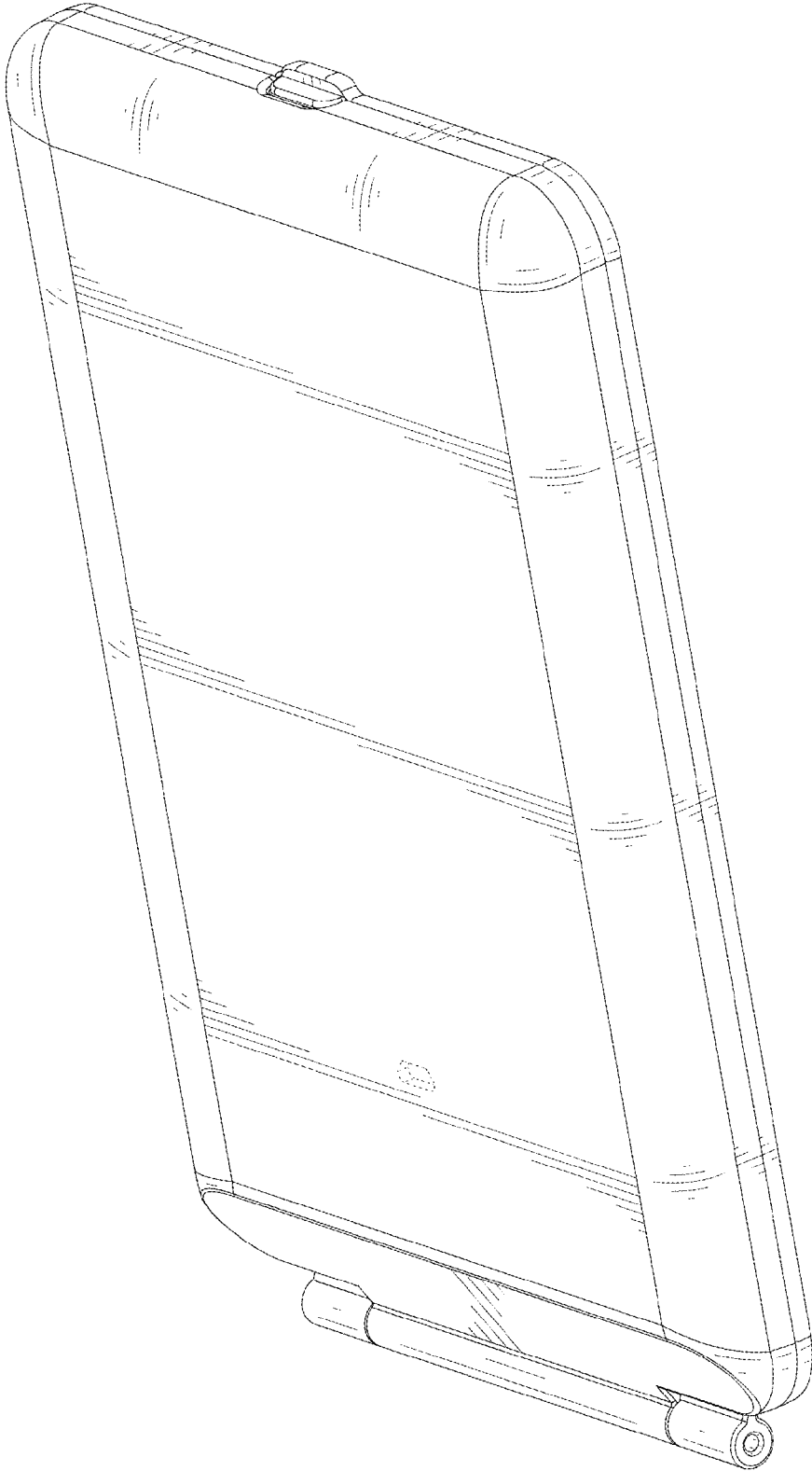

FIG.2

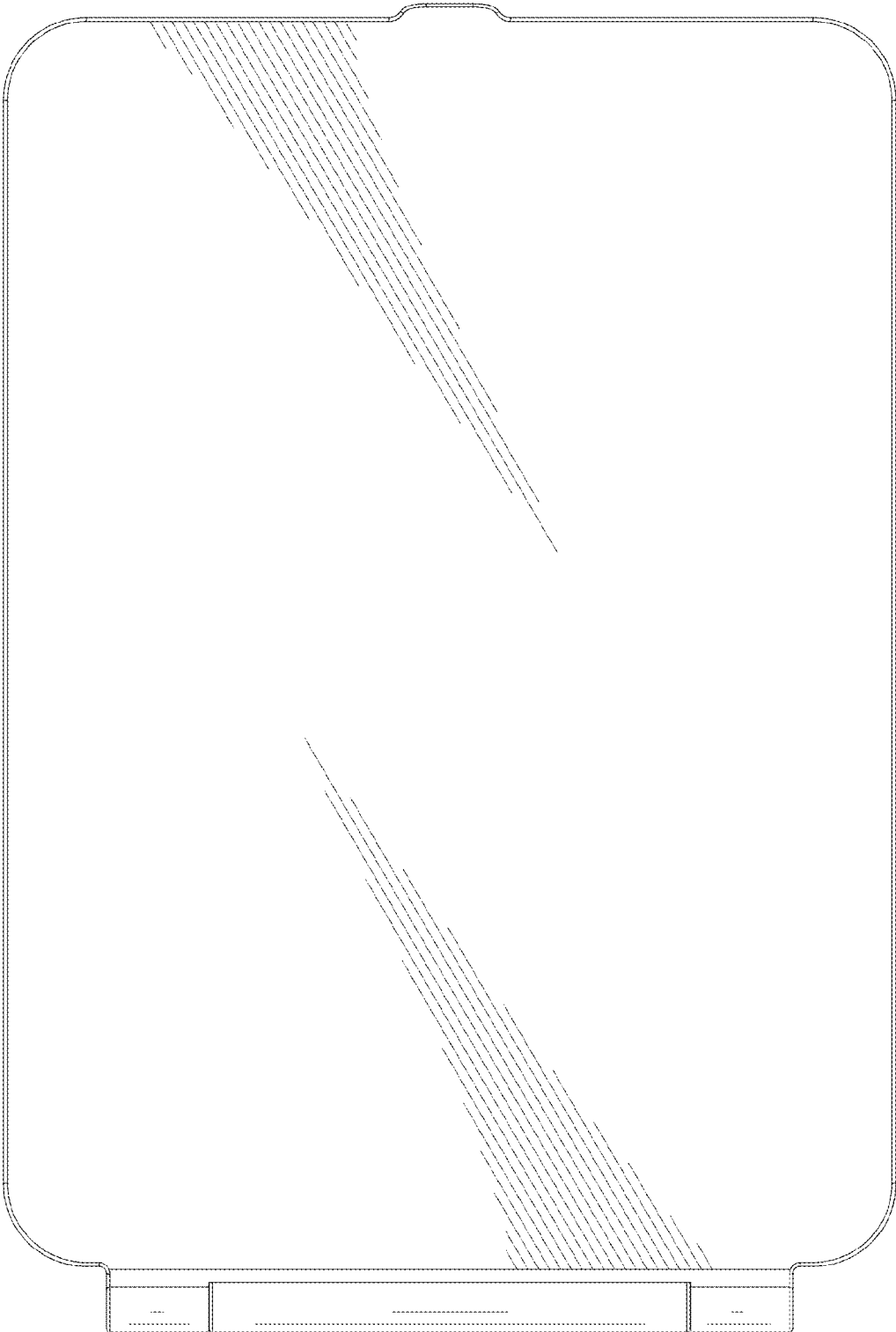

FIG.3

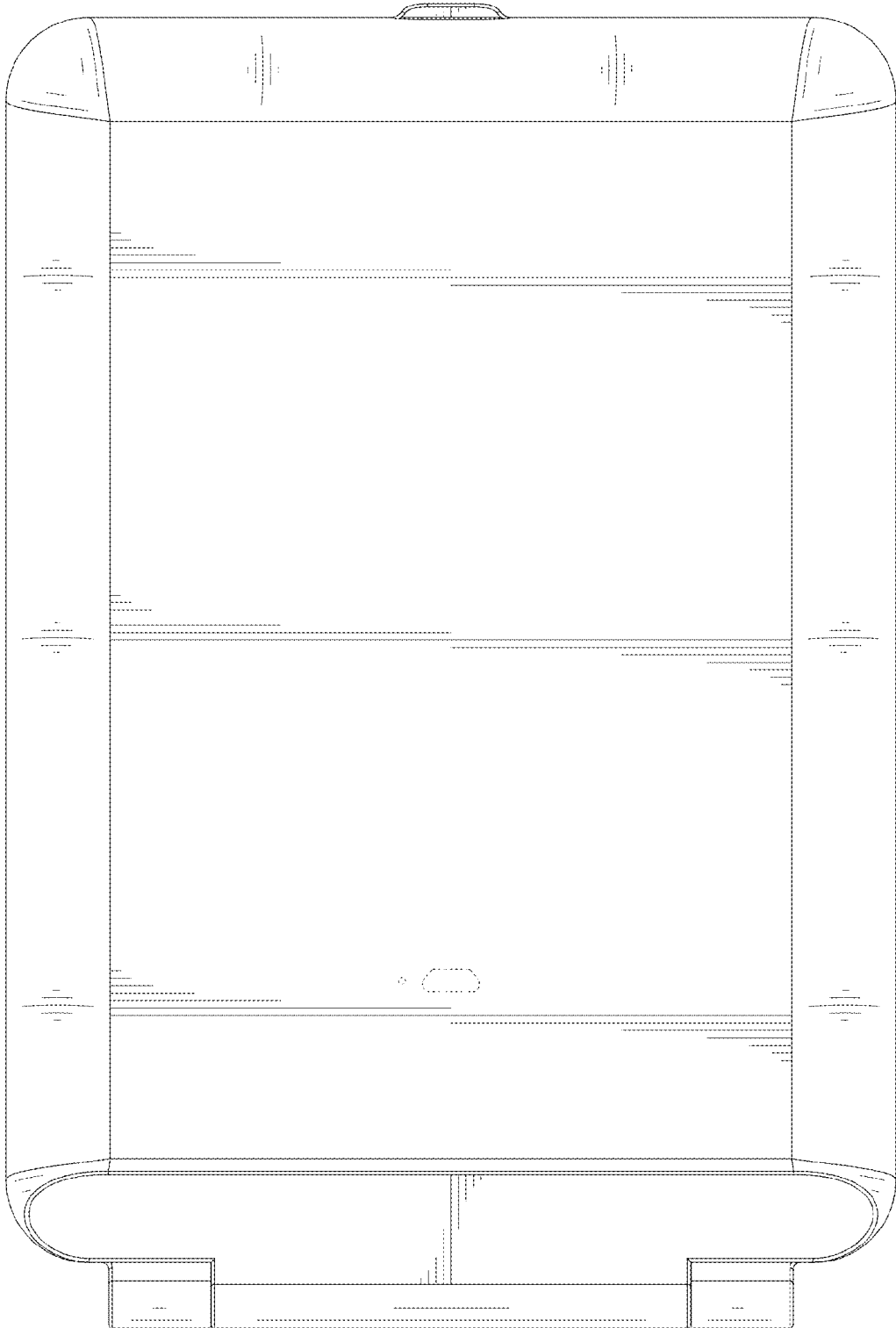

FIG.4

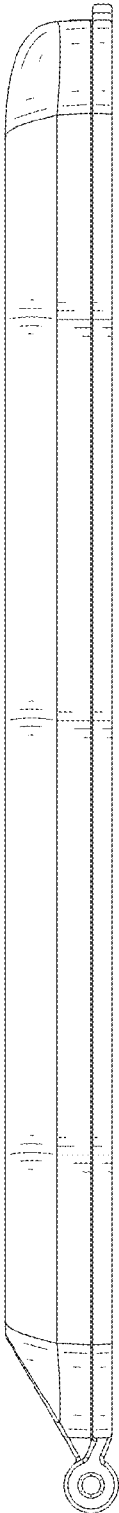

FIG.5

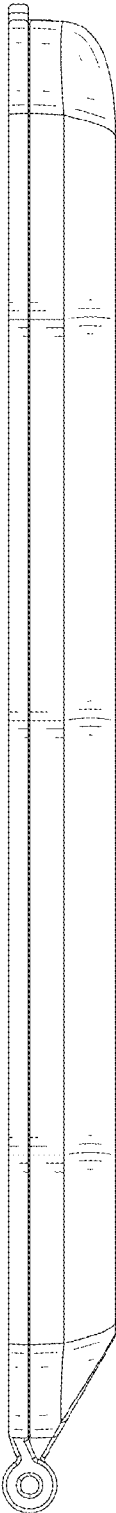

FIG.6

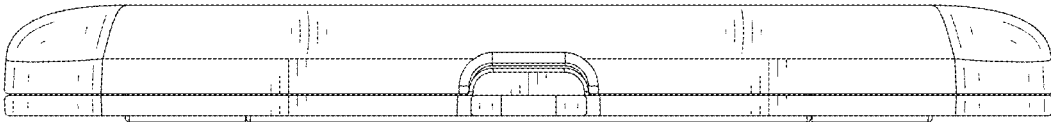

FIG.7

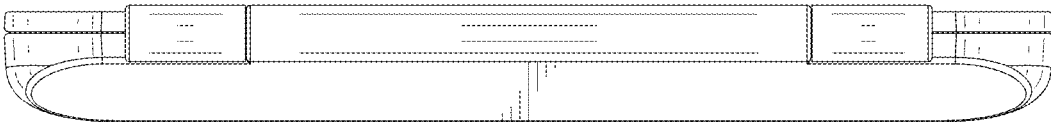

FIG.8