

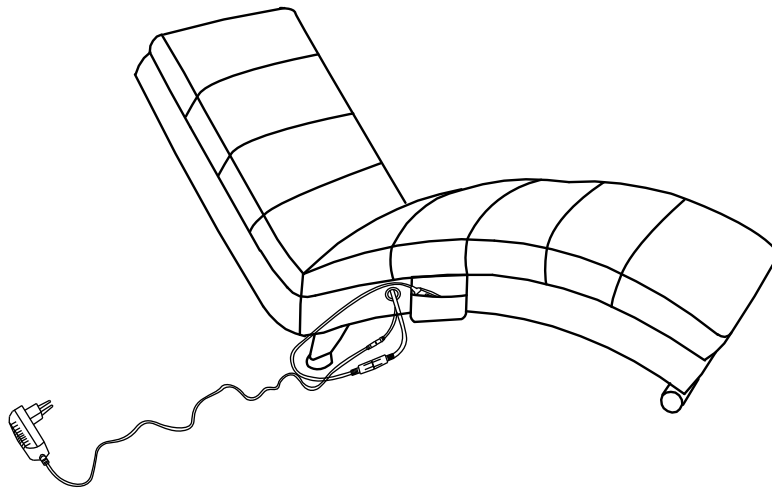

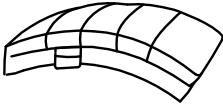

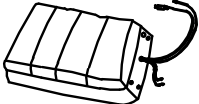





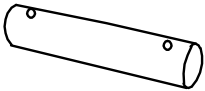

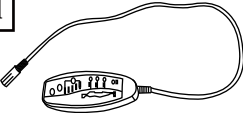
Massage Recliner Assembly Instruction



Parts List				
A  1X	B  1X	C  2X	D  1X	
E  2X	L  1X	M  1X	K  1X	N  4X
F  m8x70 7X	G  m8x30 2X	H  m6x25 8X	I  m4x16 8X	J  7X

STEP 1

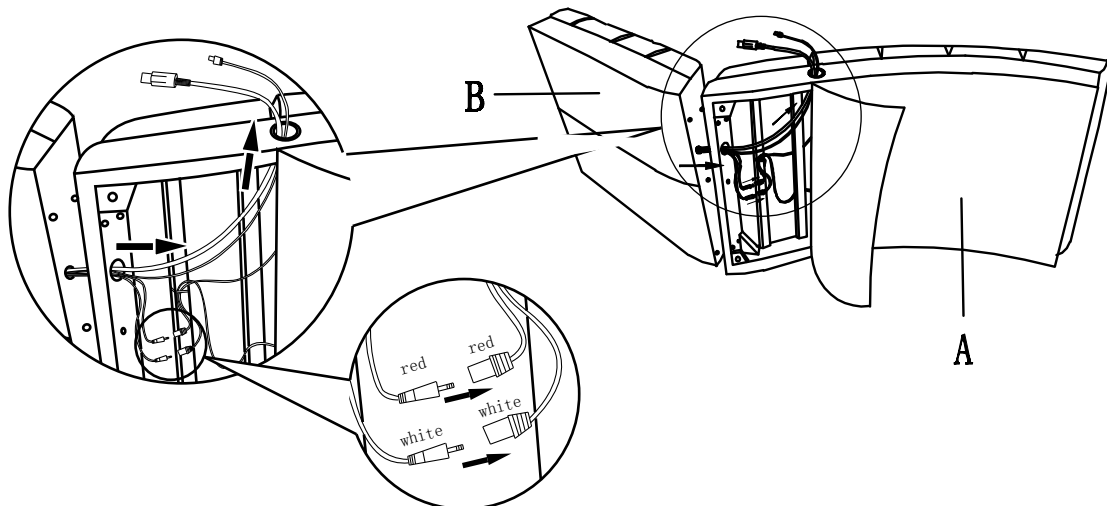

STEP 2

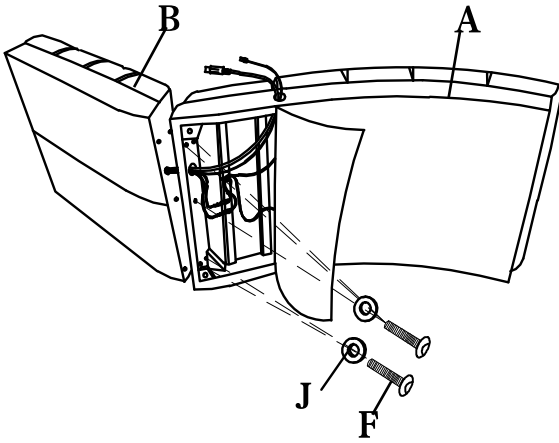

Attention: please use gasket (part J) when assemble part A and B in order to avoid over screwing.

STEP 3

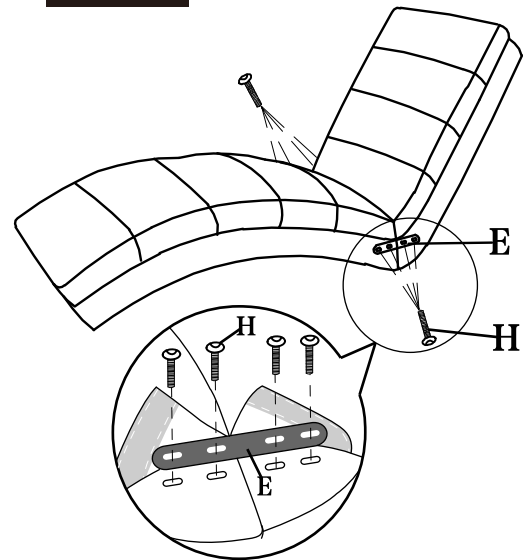

Note: Put all the screws into the hole site, and then tighten them. Do not tighten one by one.

STEP 4

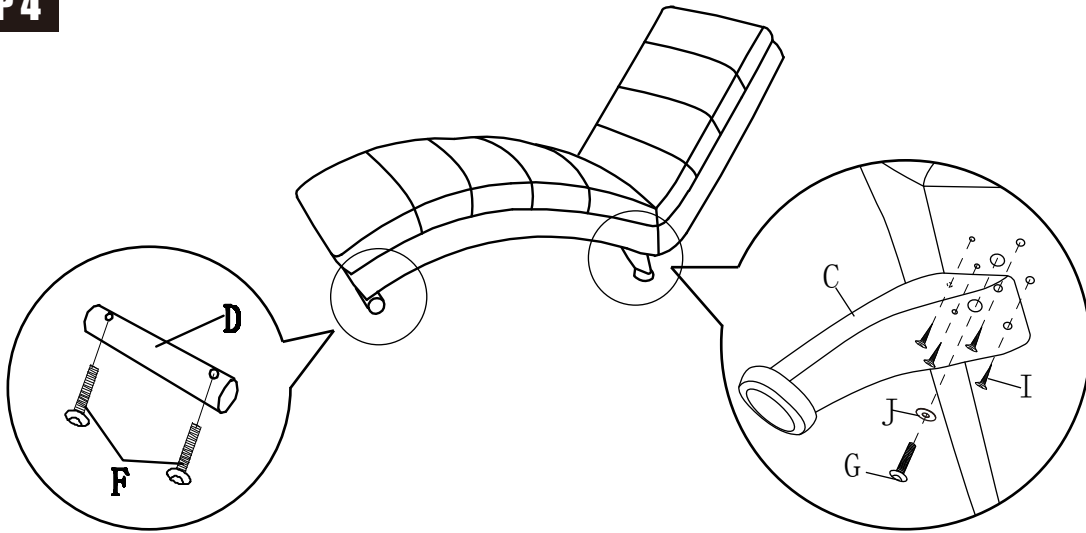

STEP 5

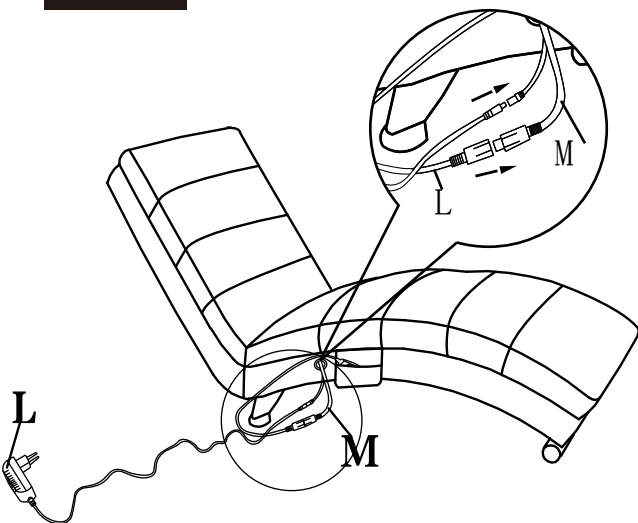

STEP 6

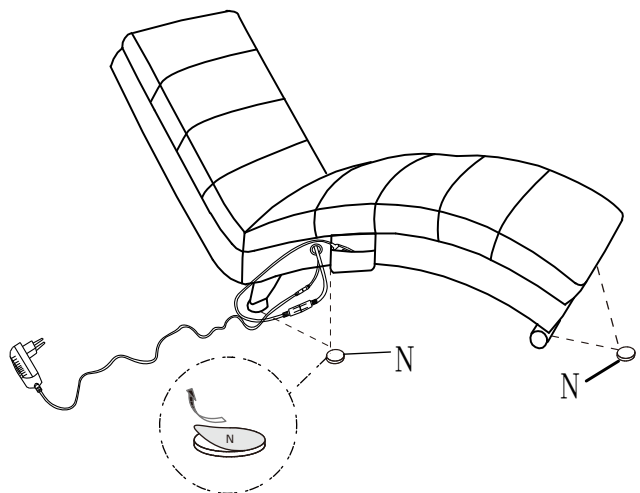

ATTENTION:

1. Please check the manual carefully and make sure you have received all the parts.
2. If there is any missing, please let us know the letter of the parts you need.
3. If there is any damage, please send clear photos to us, we will check and offer you best solution soon.