

RVL2387

FIRECLAY FARMHOUSE SINK

RUVATI[®]
SPECIFICATION SHEET

MATERIAL

- True Italian Fireclay - Made in ITALY.
- 1/2-inch thick solid fireclay.
- Fired at 2900F for extreme strength.

FEATURES

- Compatible with optional Ledge-Fit accessories.
- Large deep bowl.
- Rounded inside corners.
- Glossy enamel surface resistant



COLOR OPTIONS

BK: Glossy Black
WH: White

BS: Biscuit
EG: Emerald Green

IN THE BOX

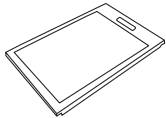

Cutting Board
[RVA1217]

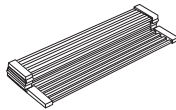

Folding Rack
[RVA1395]



Basket Strainer
[RVA1039ST]

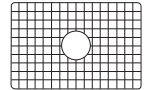

Rinse Grid
[RVA62387]

NOMINAL DIMENSIONS

Exterior: 32-1/2" (wide) x 18-3/4" (front-to-back)
Interior Bowl: 31-1/2" (wide) x 16" (front-to-back)
Bowl Depth: 9"
Minimum Cabinet Size: 36" wide
Drain Hole Size: 3 1/2"

Installation Type:
Farmhouse
Inside Corners:
Rounded
Drain Location:
Center

RUVATI USA
www.ruvati.com

Phone: 1.855.478.8284
Email: support@ruvati.com

OPTIONAL ACCESSORIES (SOLD SEPARATELY)

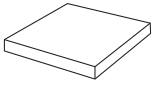

Butcher Block
[RVA2445ACA]

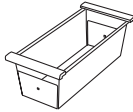

Colander
[RVA1317]

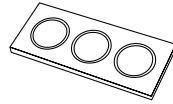

Condiment
Serving Tray
[RVA1377]

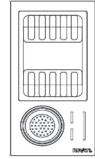

Caddy Drying Rack
[RVA1542BWC]

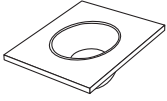

Mixing Bowl
and Platform
[RVA1288]

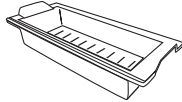

Colander
[RVA1367BLK]



Deep Basket
Disposal Flange
[RVA1049ST]



Deep Basket
Disposal Flange/Stopper
[RVA1052ST]

DIMENSIONS

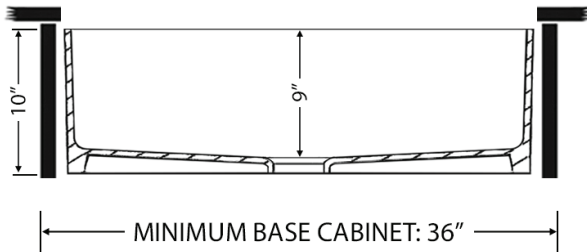
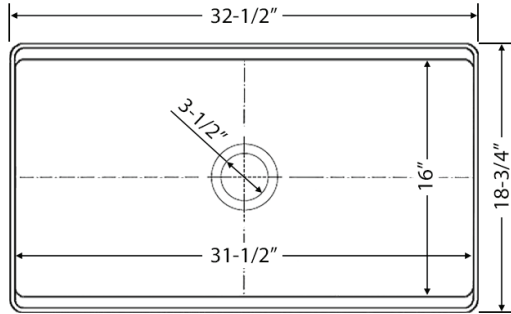

SCAN TO REGISTER YOUR WARRANTY

or visit
www.ruvati.com/register

RUVATI USA
www.ruvati.com

Phone: 1.855.478.8284
Email: support@ruvati.com