

Assembly Instruction

Accent Cabinet









Assembly Instruction

⚠ WARNING:

- Read all instructions carefully and completely before assembly and use.
- Retain for future reference.
- DO NOT use power tools.
- DO NOT over-tighten hardware.
- Periodically check all hardware and re-tighten as necessary.
- DO NOT use product if any component becomes damaged.
- For residential (non-commercial) use only.
- DO NOT sit or stand on product. Use only for intended purpose.
- DO NOT exceed 80lbs for the tabletop, evenly distributed.

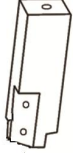
Parts List

Check all parts before assembly

| | | | |
|--|--|--|---|
| <p>A. <u>Item Body</u></p>  <p style="text-align: right;">*1</p> | <p>B. <u>Leg</u></p>  <p style="text-align: right;">*2</p> | <p>C. <u>Leg</u></p>  <p style="text-align: right;">*2</p> | |
| <p>H1. <u>Hex bolt</u></p>  <p style="text-align: center;">*8(+1 extra)</p> | <p>H2. <u>Washer</u></p>  <p style="text-align: center;">*8(+1 extra)</p> | <p>H3. <u>Foot pad</u></p>  <p style="text-align: center;">*4</p> | <p>H4. <u>Alley key</u></p>  <p style="text-align: right;">*1</p> |

Step 1: Put the Tabletop (A) on a soft surface to protect the finish.
Attach the Legs (B&C) with Hex bolts (H1) and Washers (H2) using Allen key (H4) as below photo shown. Ensure the Legs (C) on the back side.

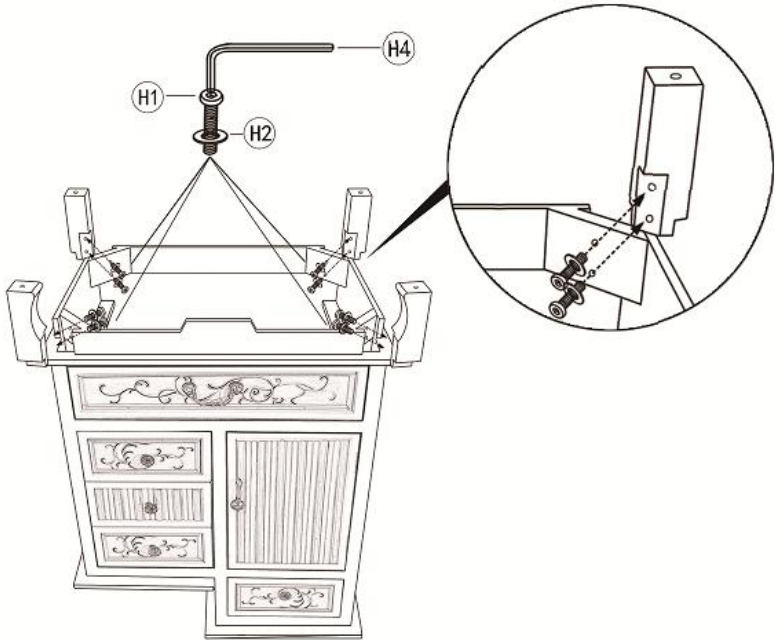

Step 2: Attach the Foot pads (H3) to the bottom of all Legs as shown in picture below.



Assembly finished.

