

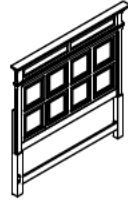

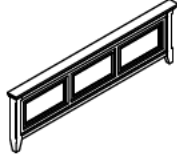

ASSEMBLY INSTRUCTION





DESCRIPTION: QUEEN PANEL HEADBOARD
QUEEN PANEL FOOTBOARD
PANEL BED RAILS

Thank you for purchasing this quality product. Be sure to check all packing material carefully for small parts which may have come loose inside the carton during shipment. Identify and count all parts and compare with the parts List Below:

PART LIST:

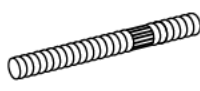
| | | | | |
|--|--|---|--|--|
| <p>①</p>  <p>HEADBOARD: 1PC</p> | <p>②</p>  <p>FOOTBOARD: 1PC</p> | <p>③</p>  <p>SIDE RAIL: 2PCS</p> | <p>④</p>  <p>QUEEN BED SLATS: 4PCS</p> | <p>⑤</p>  <p>SUPPORT LEGS: 4PCS</p> |
|--|--|---|--|--|

HARDWARE LIST :

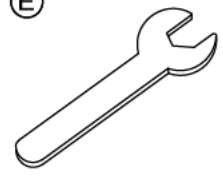
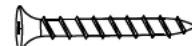
| | | | | | |
|--|--|---|---|---|---|
| <p>Ⓐ</p>  <p>THREADED BOLT (Ø5/16"-18 X3-1/2"): 8PCS</p> | <p>Ⓑ</p>  <p>FLAT WASHER (Ø5/16"X19MM): 8PCS</p> | <p>Ⓒ</p>  <p>SPRING WASHER (Ø5/16"): 8PCS</p> | <p>Ⓓ</p>  <p>HEX NUT (Ø5/16"-18) : 8PCS</p> | <p>Ⓔ</p>  <p>WRENCH Ø5/16" (12MM) : 1PC</p> | <p>Ⓕ</p>  <p>WOOD SCREW Ø8 X 1" : 8PCS</p> |
|--|--|---|---|---|---|

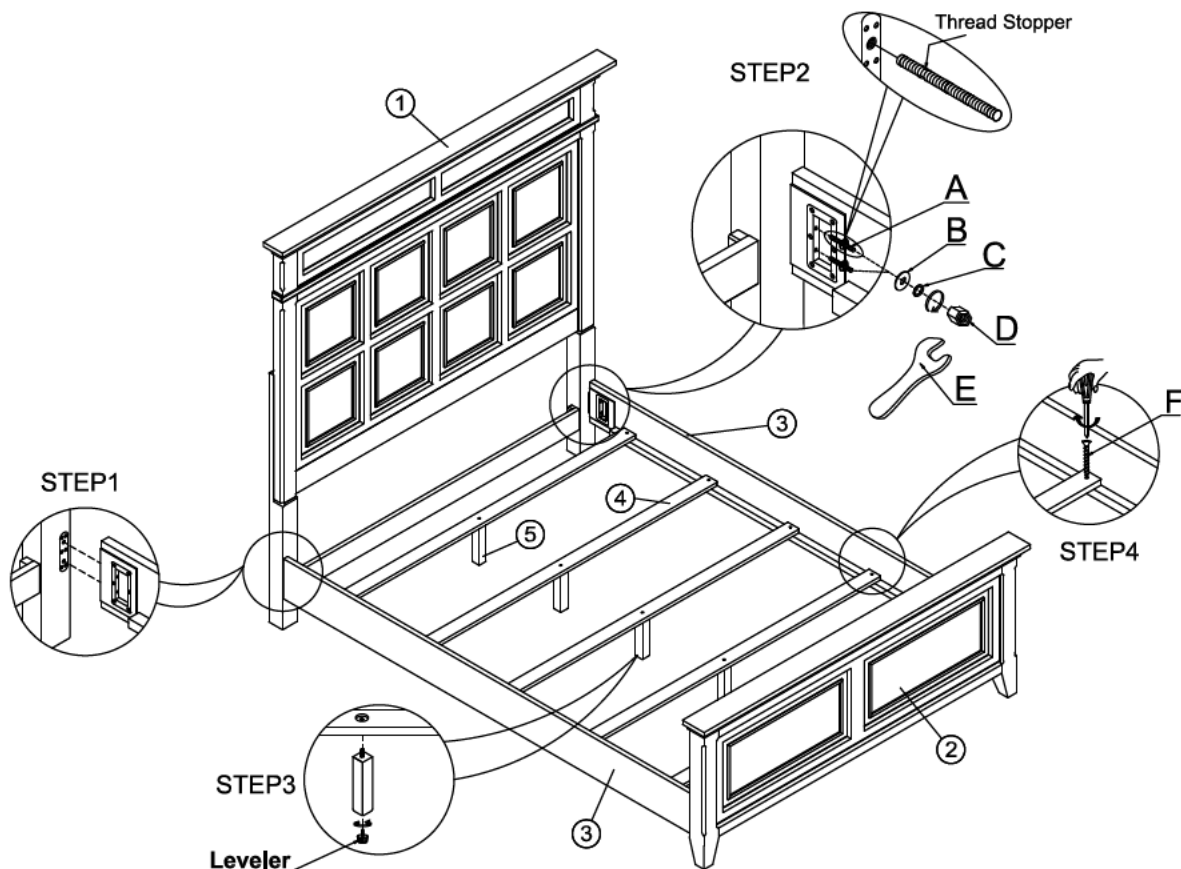

CLEANING INSTRUCTION

Page 1/1 Clean the furniture surface with furniture polish and soft cloth.