



# ASSEMBLY INSTRUCTIONS

Thank you for purchasing this quality product.

Please read instructions carefully prior to assembly.

Check carefully for small parts which may have come loose during transportation inside all the boxes. Remove from boxes and place all parts and components on soft surface such as carpet, blanket or furniture pad. Identify and verify all parts and hardware as specified below.

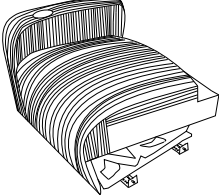
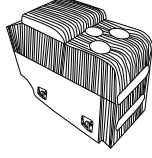
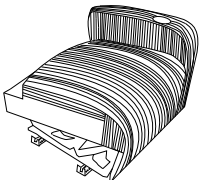
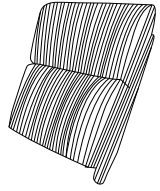
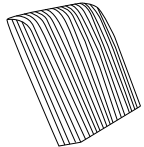
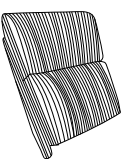
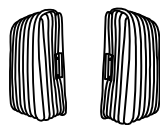
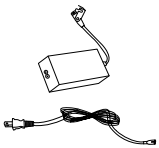
## PART LIST:

A	1	B	1	C	1	D	1	E	1
									
F	1	E	1	H	3	I	1		1
									

## Assembly Tips:

Anything that could make the assembly process easier based on factory assembly procedures and experience. In example:

- Place table top upside down
- Do not tighten screws and bolts until final steps of the assembly
- This assembly may require additional help (2 person set up)

## STEP 1

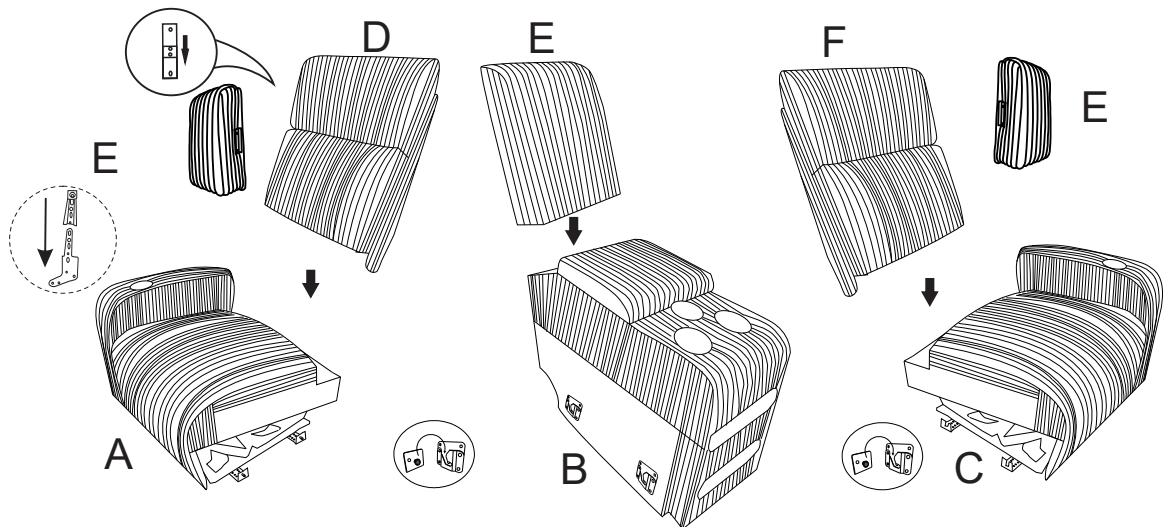

## STEP 2

