

INSTALLATION GUIDE FOR 9074-A

WARNINGS AND CAUTIONS

Released Date:2026-02

READ AND SAVE THESE INSTRUCTIONS

Please read and understand this entire manual before attempting to assemble, install or operate the product.

WARNING

- RISK OF ELECTRIC SHOCK - Before beginning installation, turn off electricity at the circuit breaker box or the main fuse box.
- RISK OF FIRE - Use bulbs specified by the markings and/or labels on the fixture.
- RISK OF PERSONAL INJURY - DO NOT bend the blades when installing the fan, or cleaning the fan. Do not insert foreign objects in between rotating fan blades.
- RISK OF FIRE, ELECTRIC SHOCK, OR PERSONAL INJURY - mount to outlet box marked and use mounting screws provided with the outlet box.
- All set screws must be checked, and re-tightened where necessary, before installation.
- After making the wire connections, the wires should be spread apart with the grounded conductor and the equipment-grounding conductor on one side of the outlet box and the ungrounded conductor on the other side of the outlet box.

CAUTION

- For your safety, read instructions completely before beginning installation.
- If in doubt about electrical installation, consult a licensed electrician.
- Disconnect fixture from the power source before replacing bulbs or cleaning. Make sure the bulbs are given sufficient time to cool before removing.

TOOLS REQUIRED

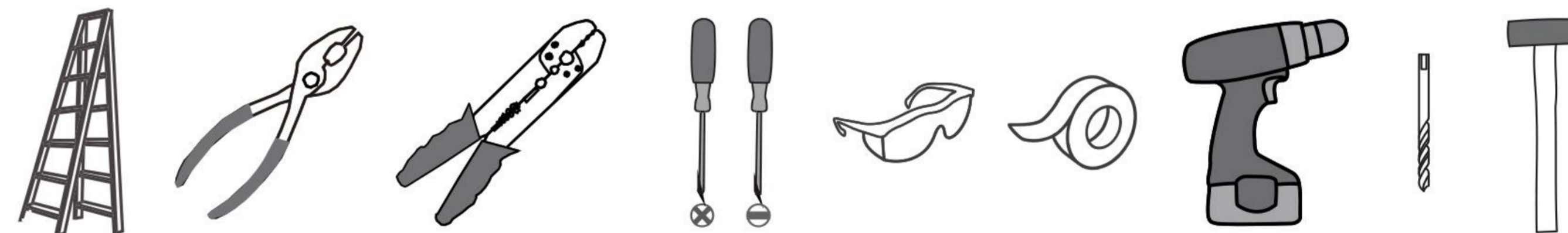

CARE AND MAINTENANCE

- Wipe clean using soft, dry cloth or static duster. Always avoid using harsh chemicals and abrasives to clean fixture as they may damage the finish.

If you need further assistance contact our After Customer Care at
betteraftersaleservice01@outlook.com,
we will reply you in 24 hours.

PACKAGE CONTENTS

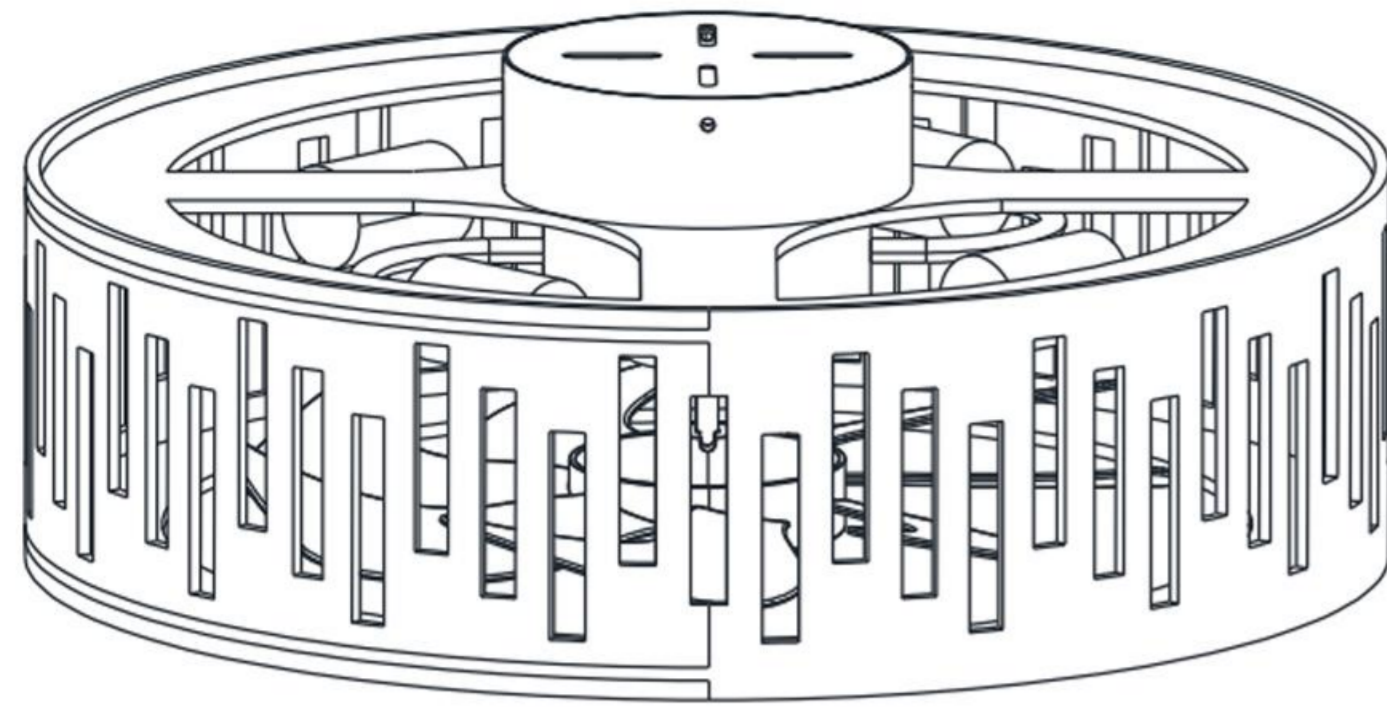

A Fixture Body
x 1



NOTE: Hardware not shown to actual size.

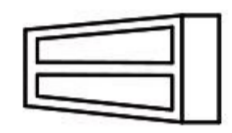

AA Wire Connector
x 4

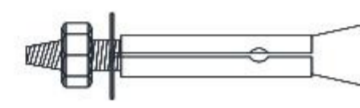

DD Anchor Bolt
x 4

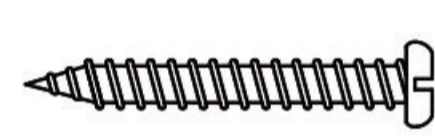

BB Screw
x 4



EE Mechanical Screw
x 4



CC Wall Anchor
x 4

PACKAGE CONTENTS (PARTS BAG 2)

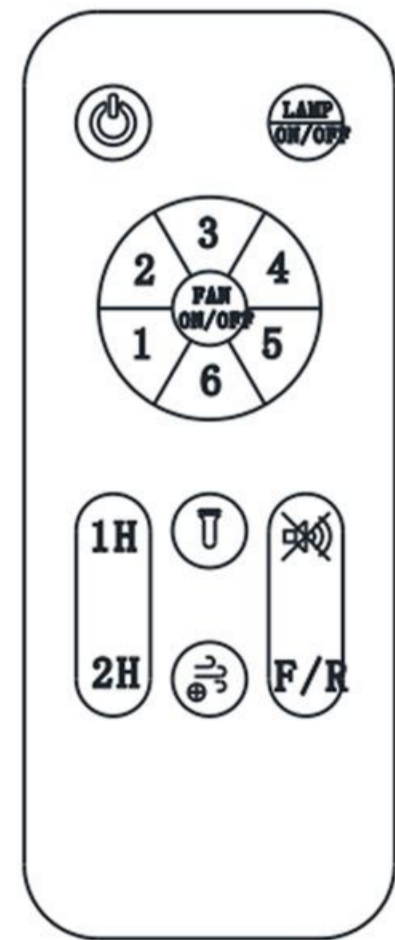

MM Remote Control
x 1

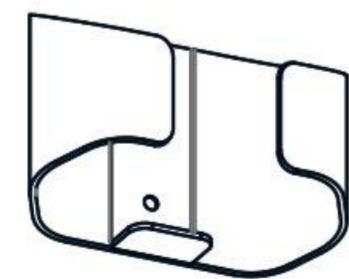

OO Wall Bracket
x 1



PP Screw
x 2

INSTALLATION

9 Remote Control Instruction

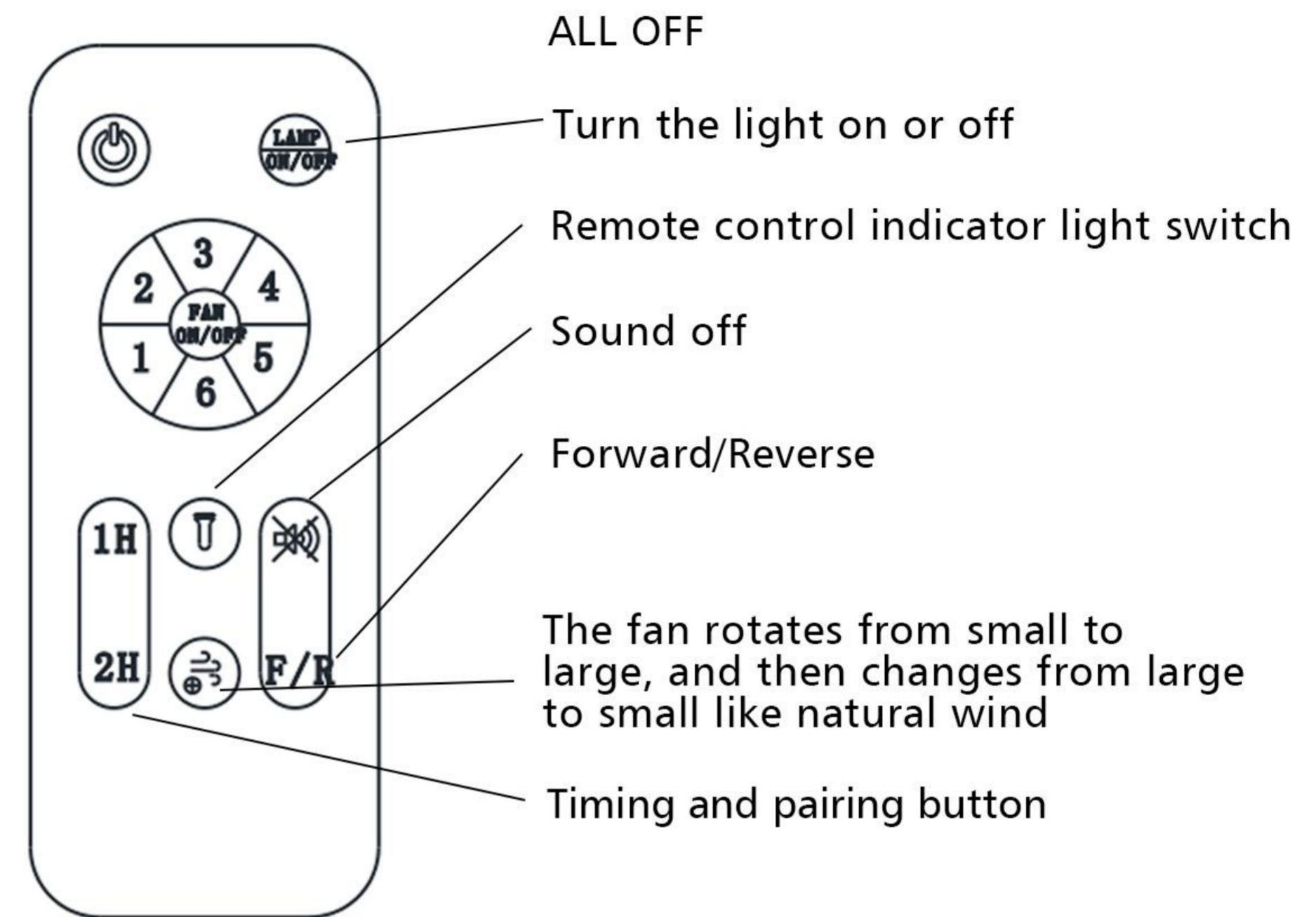

Remote Control Pairing Instructions:

(If the remote is not working, please refer to this method)

1. Turn on the wall switch (if it's already on, please turn it off first, then back on).
2. Press and hold the 2H button for 5 seconds to pair the fan light with the remote control.
3. A beep sound will be heard after successful pairing.

Your installation is now complete. Save this sheet for future

INSTALLATION

7 Install Wall Bracket

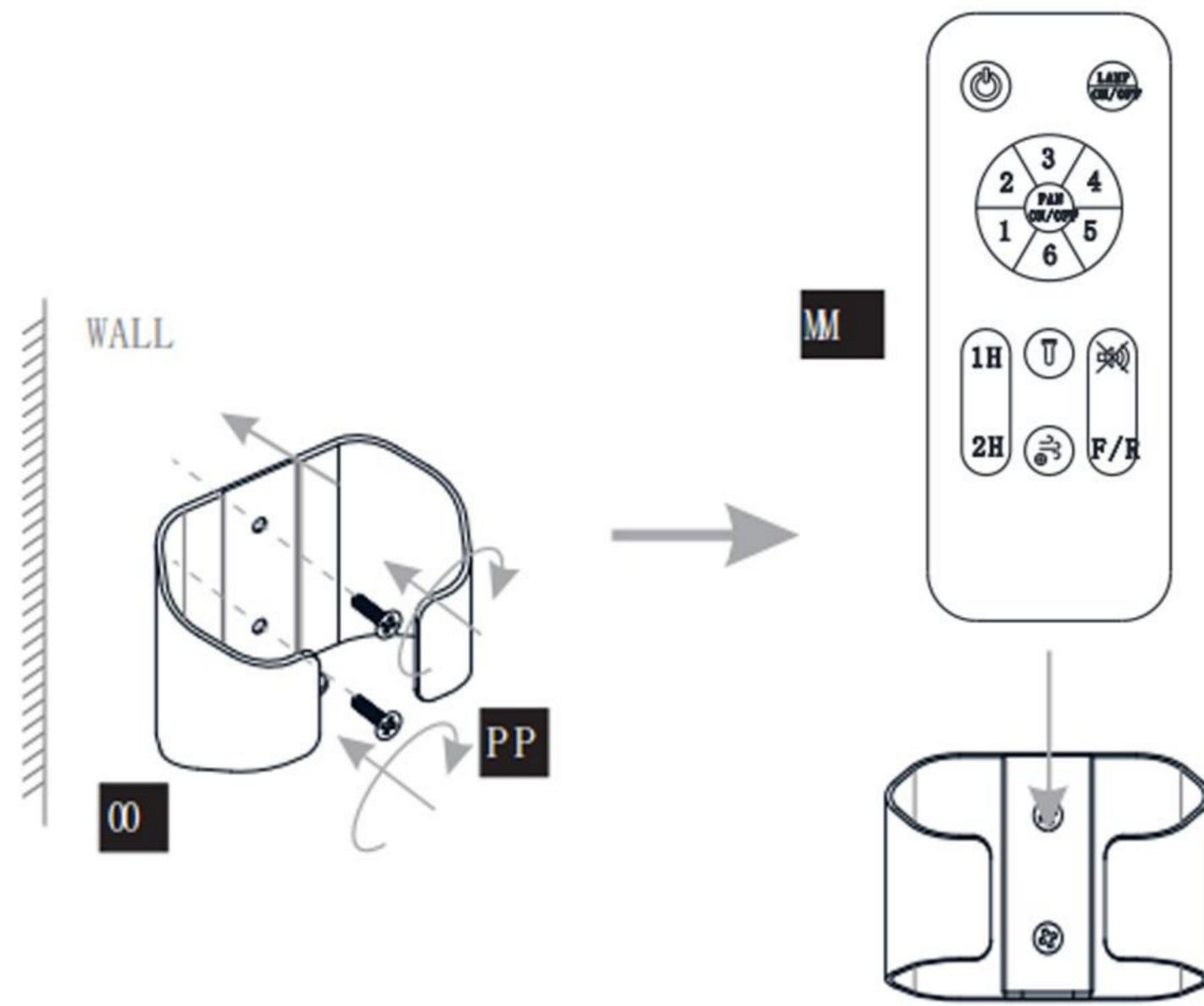

8 Install Remote Control

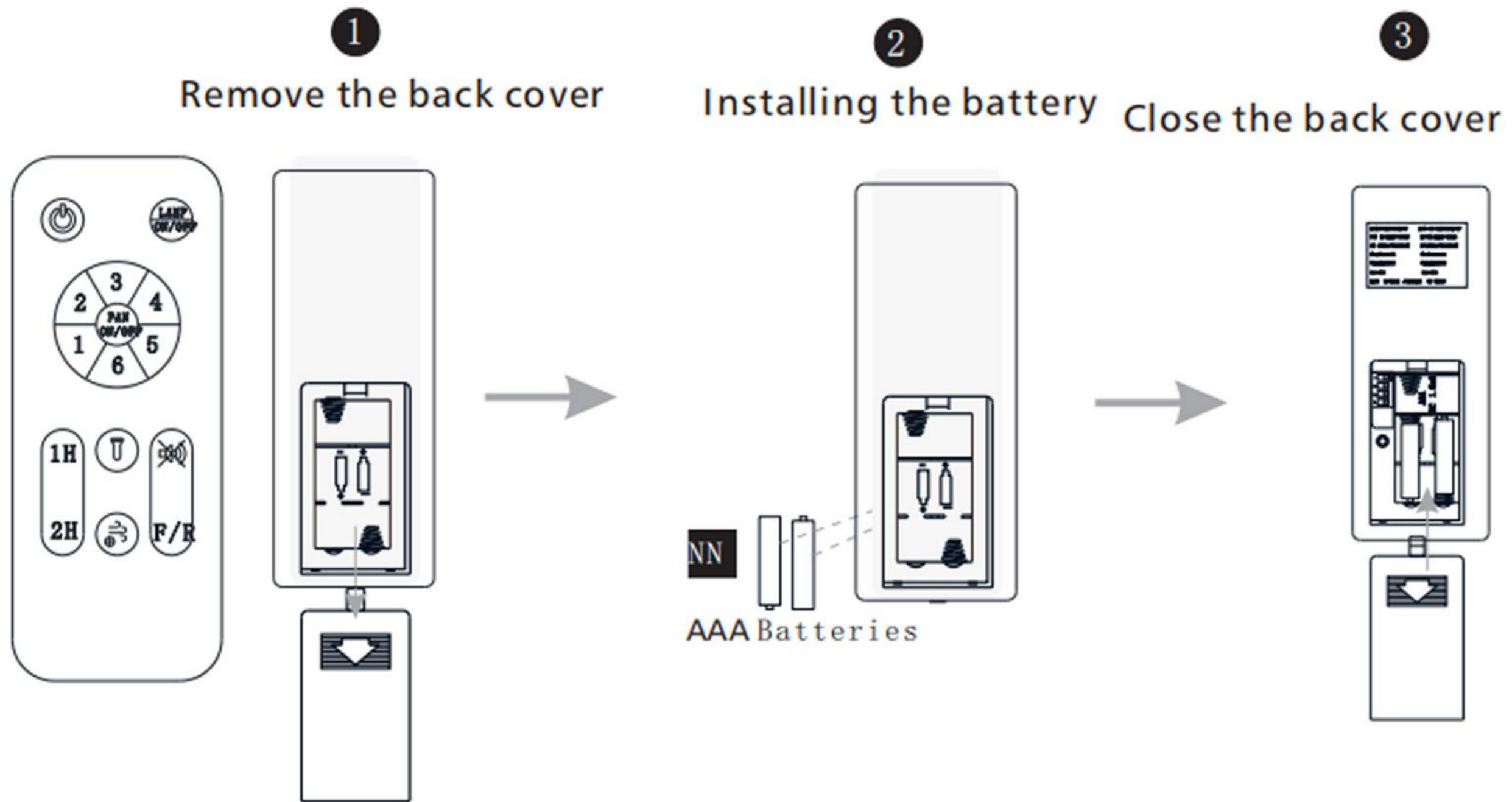

INSTALLATION

1 Remove the mounting bracket

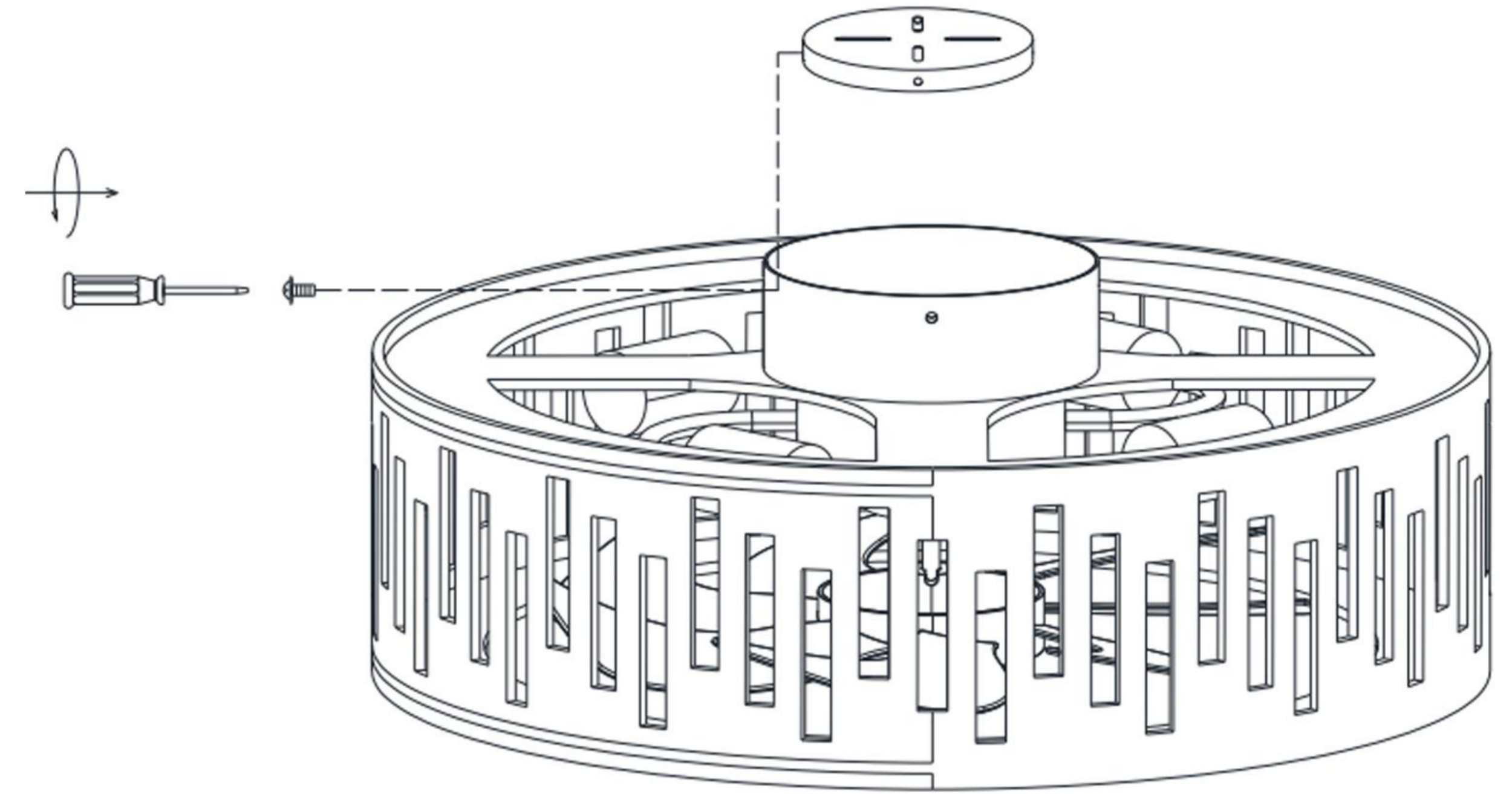

2 Install the mounting bracket onto the outlet box

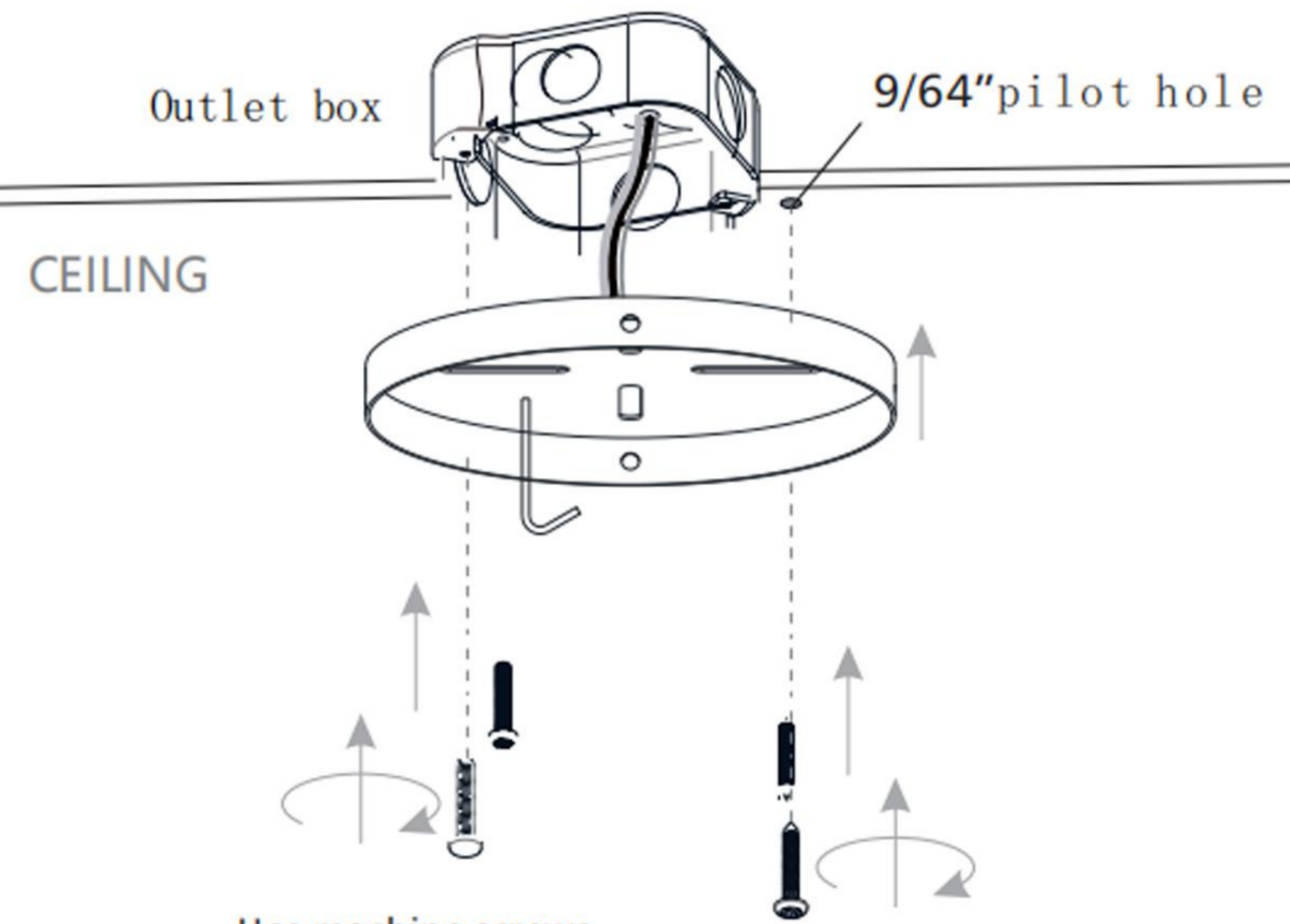

Use machine screws when securing to existing ceiling fan-rated outlet box.

INSTALLATION

3 Hang the fixture body onto the mounting bracket using the safety cable

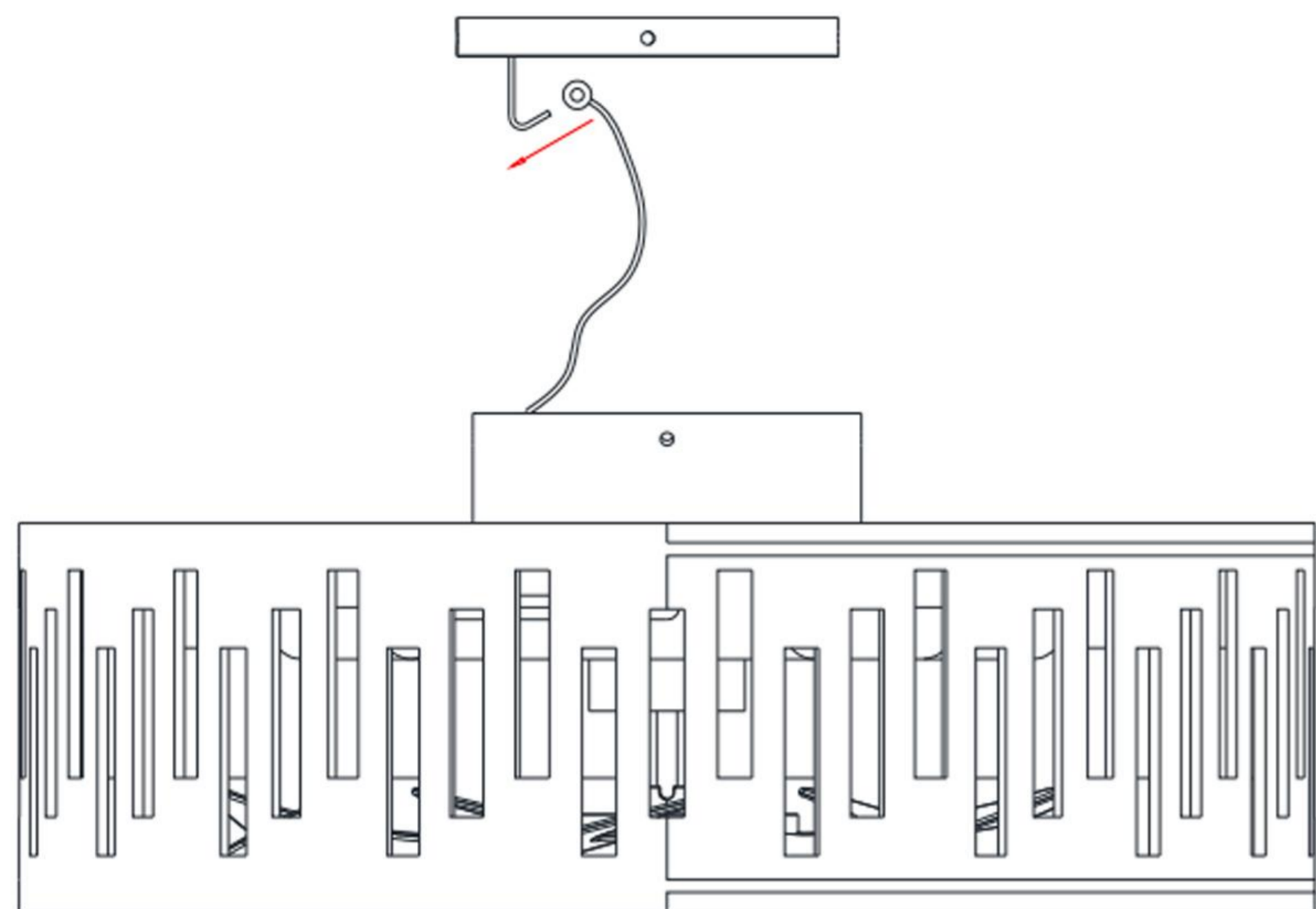

4 Wiring

1. Connect the black wire to the live wire
2. Connect the white wire to the neutral wire
3. Connecting ground

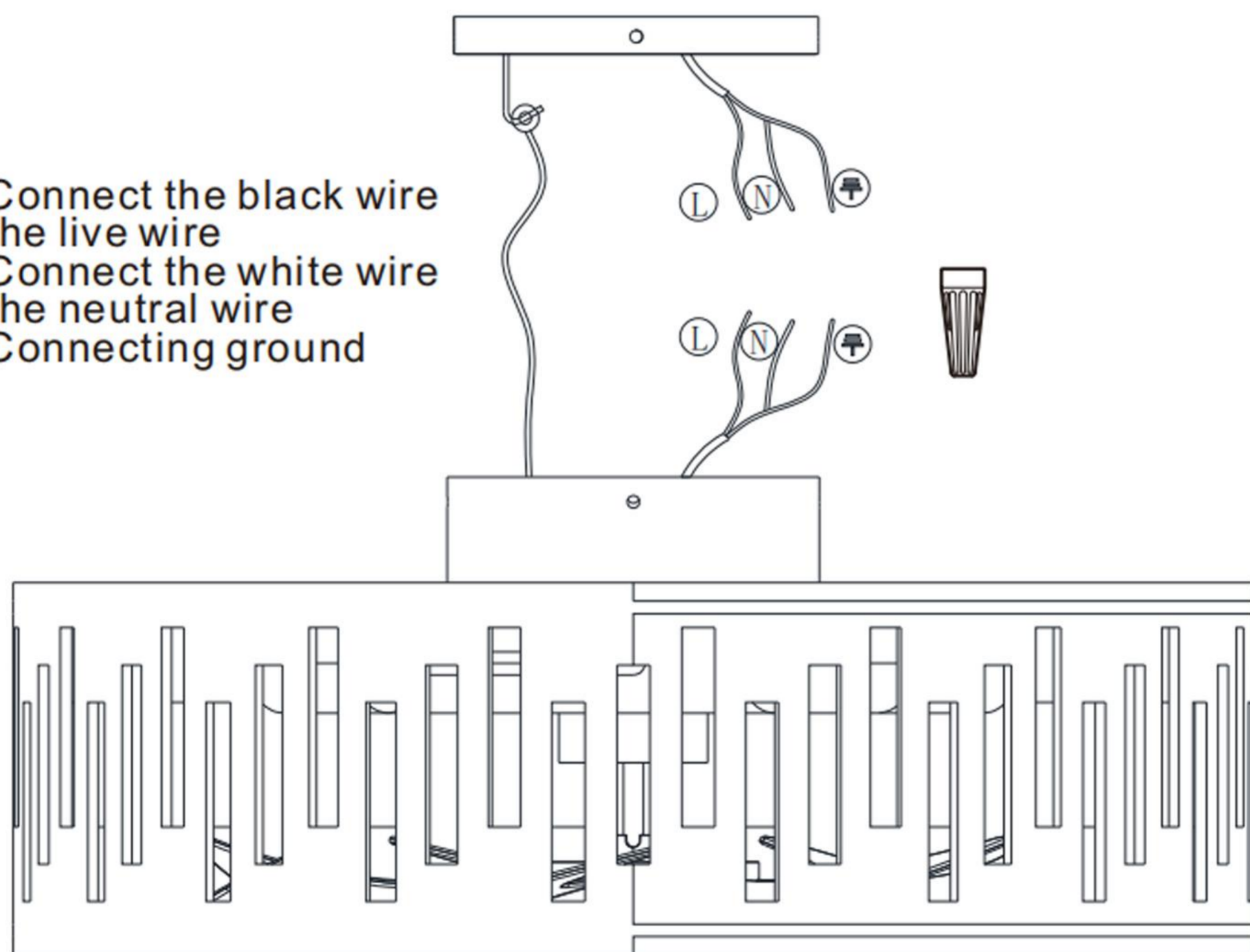

INSTALLATION

5 Take out the mounting bracket screws, pass them through the fixture body, and fasten them to the mounting bracket mounted on the ceiling

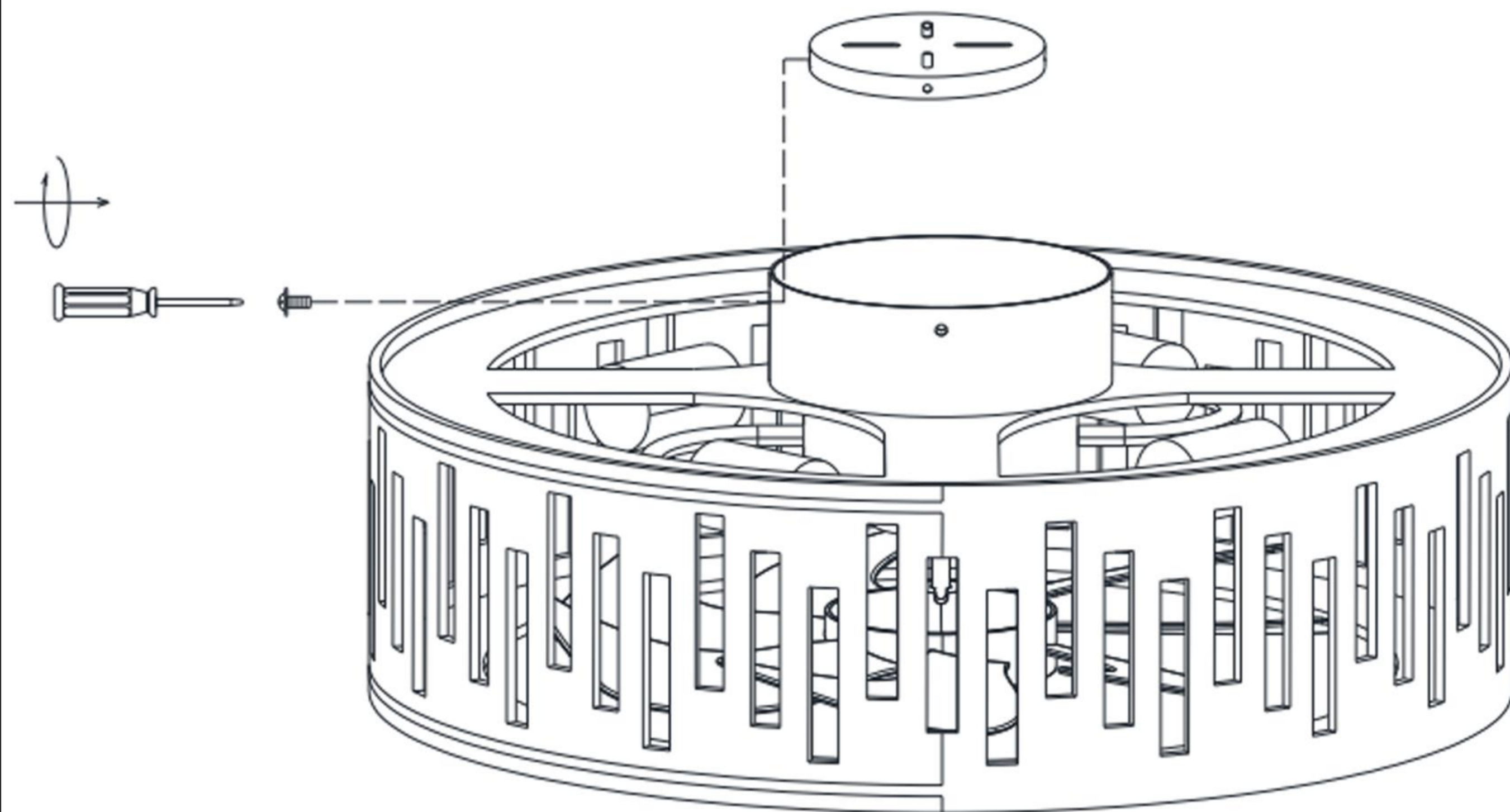

6 Install 4*E26 bulbs(not included)

