







Installation Instruction

Part List and Hardware List

ITEM	PICTURE	DESCRIPTION	QUANTITY	ITEM	PICTURE	DESCRIPTION	QUANTITY
A		Mounting Bracket	X1	J			
B		Self-tapping Screws	X2	K			
C		Canopy	X1	L			
D		M4 Nuts	X2	M			
E		Downrods	15.7"X3 5.9"X1	N			
F		Metal Oval Frame	x1	O		Wire connectors	X3
				P		Line Wire	X1
				Q		Neutral Wire	X1
H		Lamp Body	X1	R		Ground wire	X1

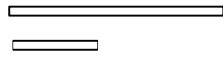
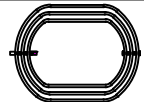
1

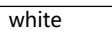
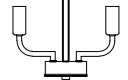
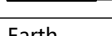
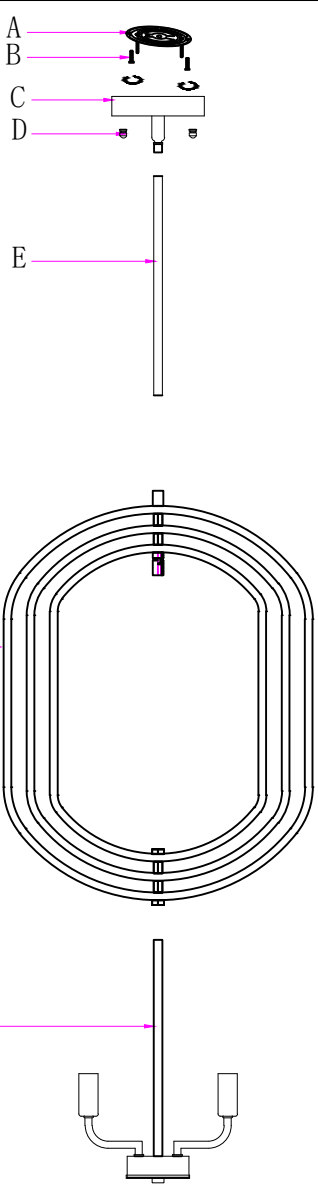

2

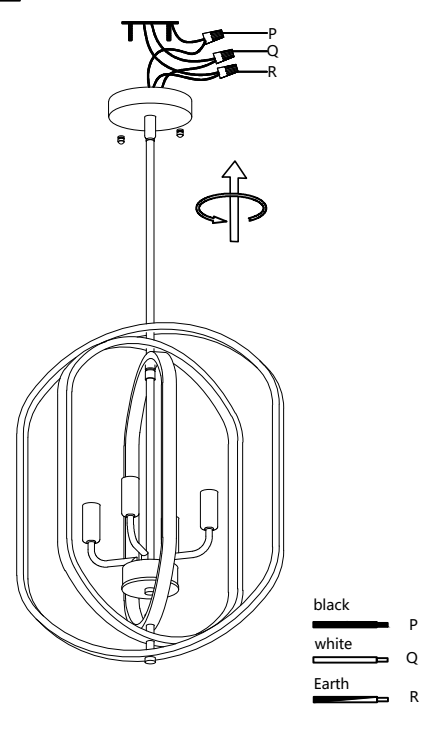

Step 2:
 4. Connect the wires and your home wires to the connector (black to black, white to white, earth to earth)
 5. Install the light fixture to the ceiling with M4 nut(D)

3

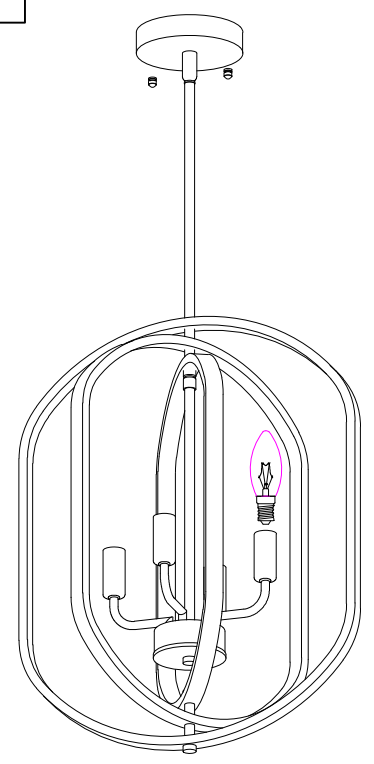

Step 3:
 6. Finally, install the E12 light bulb to complete the installation.

Step 1:
 1. Fix the Mounting Bracket(A) into the ceiling with Self-tapping screw(B)
 2. Then use the Lamp Body(H) to connect with Metal Oval Frame(F), and then use Downrods (E) to connect with Metal Oval Frame(F)