

# MANGLE Bathtub Mounting Guide

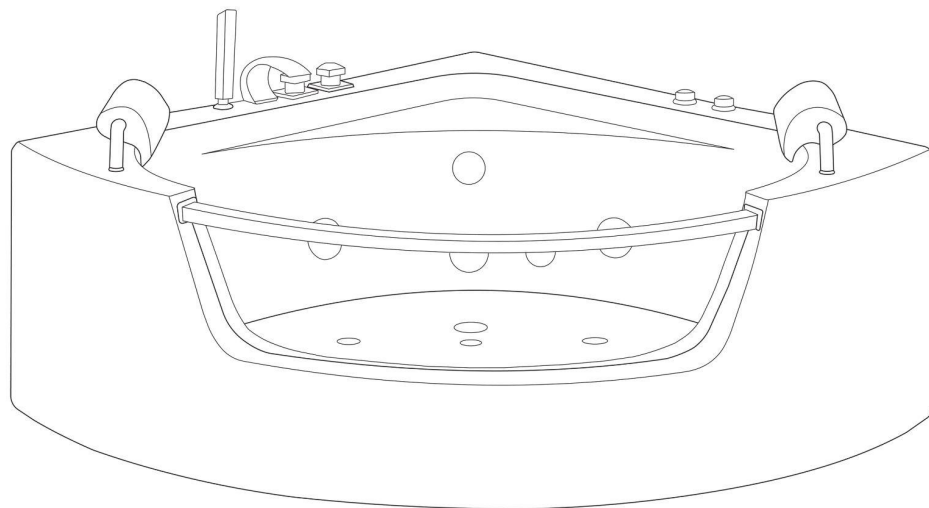

## Table of Contents

Čeština (CZ) .....	1
Dansk (DK) .....	6
Nederlands (NL) .....	9
English (ENG) .....	12
Suomi (FI) .....	15
Français (FR) .....	18
Deutsch (DE) .....	22
Magyar (HU) .....	25
Italiano (IT) .....	28
Norsk (NO) .....	31
Polski (PL) .....	34
Português (PT) .....	37
Español (ES) .....	40
Svensk (SE) .....	43
Slovenčina (SK) .....	46

# Čeština (CZ)

## Návod na instalaci hydromasážní vířivé vany s LED osvětlením

Děkujeme, že jste si vybrali naši vířivou vanu. Před instalací si připravte následující pomůcky:

1. Vodováha

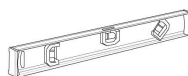

2. Francouzský klíč



3. Silikonová pistole

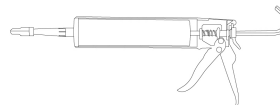

## INSTALACE

1. Vyalte vanu z krabice a ujistěte se, že podlaha, na kterou ji chcete umístit, je rovná.

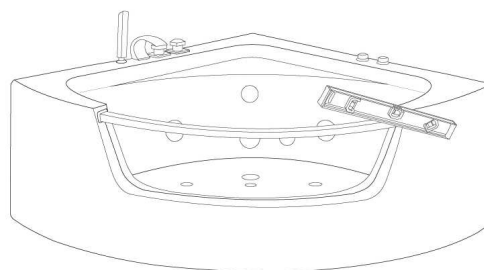

2. Umístěte vanu do rohu, do kterého ji chcete nainstalovat.

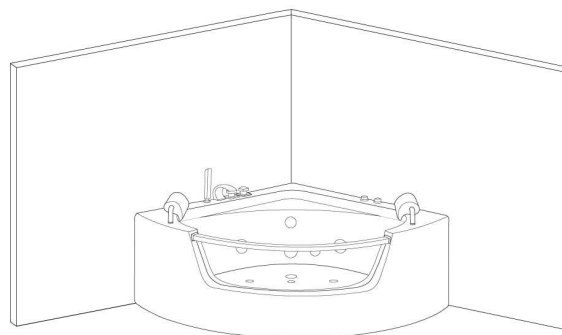

3. Připojte baterii a následně i sprchovou hlavici k vaně.

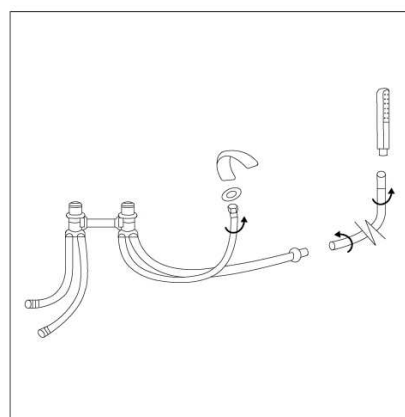

4. Připevněte opěrky hlavy.

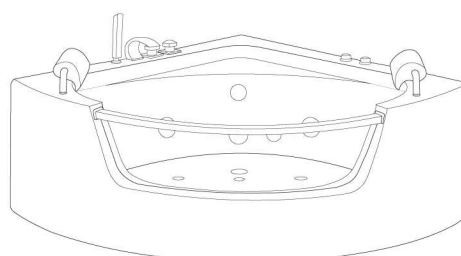

5. Připojte odtokovou hadici k vypouštěcímu ventilu a hadice k přívodu vody.

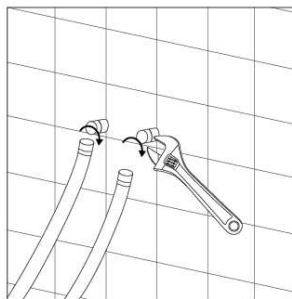

6. Použijte silikonovou pistoli na utěsnění vany.

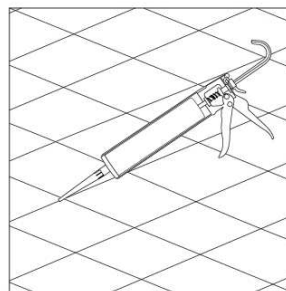

7. Zasuňte zástrčku vany do zásuvky.

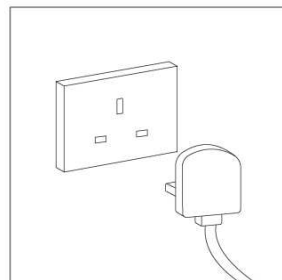

# Dansk (DK)

## Spabad med LED installationsvejledning

Tak fordi du har valgt vores spabad. Før installationen skal du have:

1. Vaterpas

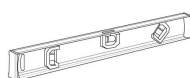

2. Justerbar skruenøgle



3. Fugepistol

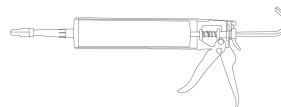

## INSTALLATION

1. For at starte installationsprocessen skal du tage badekarret ud af kassen og sørge for, at gulvet hvor du vil installere badekarret, har en jævn flade.

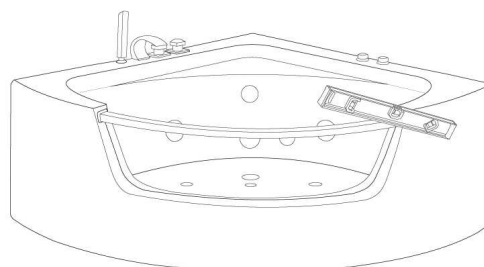

2. Placer badekarret i det hjørne, hvor du ønsker at installere det.

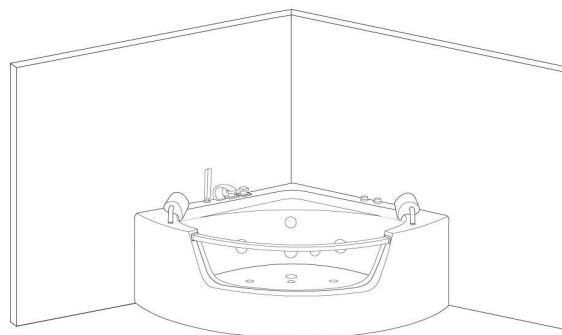

3. Tilslut først vandhanen og derefter brusehovedet til badekarret.

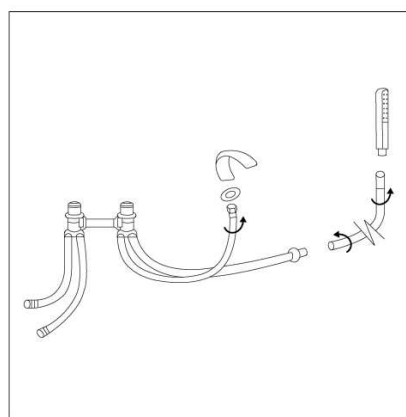

4. Monter nakkestøtter.

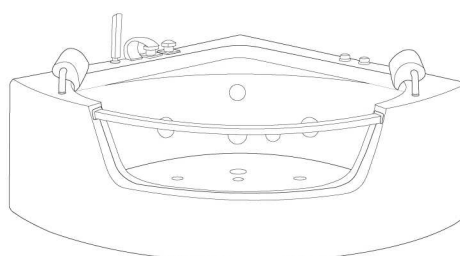

5. Forbind afløbsrøret med hovedafløbet, og monter vandforsyningsledningerne.

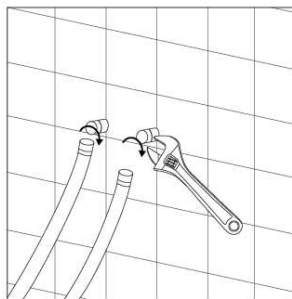

6. Brug fugepistolen til at tætnede badekarret.

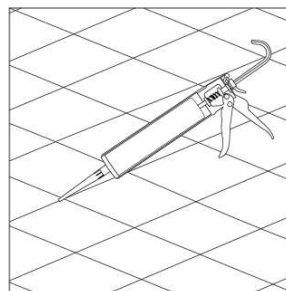

7. Sæt stikket til badekarret i stikkontakten.

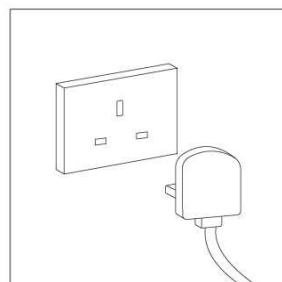

# Nederlands (NL)

## Whirlpoolbad met LED-installatie instructies

Bedankt voor het kiezen voor ons whirlpoolbad. Voor installatie heb je nodig:

1. Waterpas

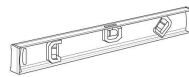

2. Verstelbare sleutel



3. Kitpistool

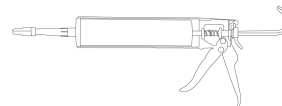

## INSTALLATIE

1. Om te beginnen met het installeren, neem de badkuip uit de doos en zorg ervoor dat de vloer waarop je de badkuip wilt installeren vlak is.

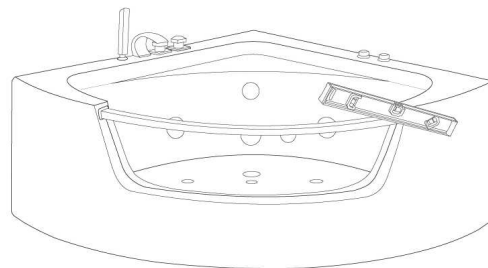

2. Plaats de badkuip in de hoek waar je hem wilt installeren.

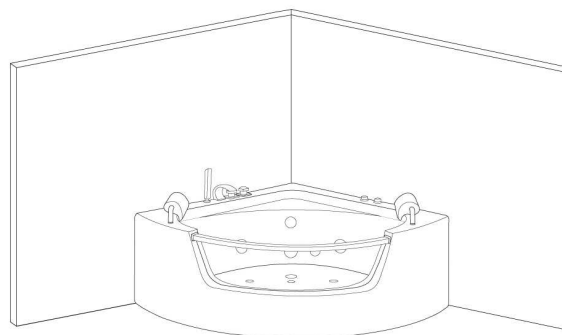

3. Sluit de kraan aan de douchekop en de badkuip.

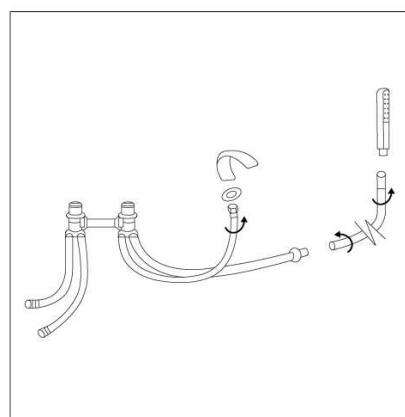

4. Installeer de hoofdsteunen.

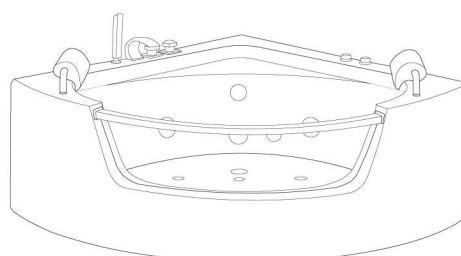

5. Verbind de afvoerpijp met de afvoer en verbind de waterkranen.

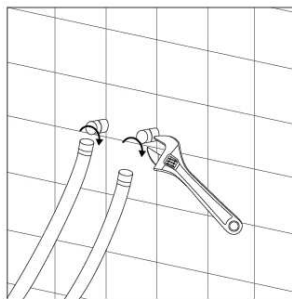

6. Gebruik het kitpistool om de badkuip af te dichten.

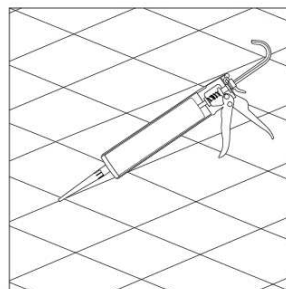

7. Doe de badkuip stekker in het stopcontact.

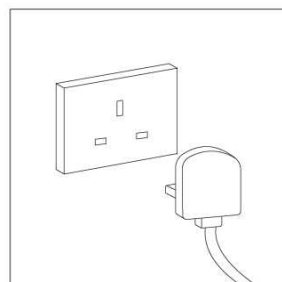

# English (ENG)

## Whirlpool Bathtub with LED Installation Instructions

Thank you for selecting our whirlpool bath. Before installation, you should have:

1. Spirit Level

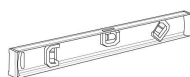

2. Adjustable Spanner



3. Silicone Gun

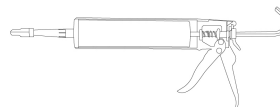

## INSTALLATION

1. To start the installation process, take the bathtub out of the box and make sure that the floor that you want to install the bathtub is flat.

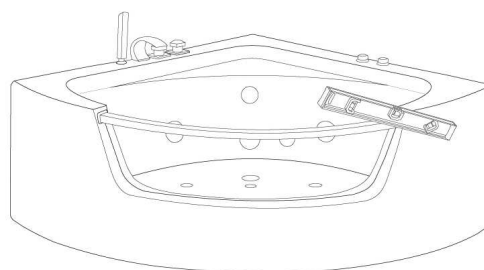

2. Place the bathtub in the corner, where you want to install it.

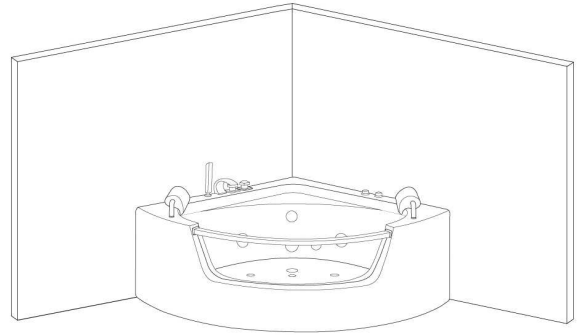

3. Connect the faucet and then the shower head to the bathtub.

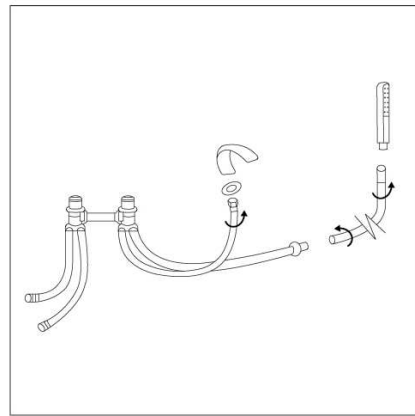

4. Install headrests.

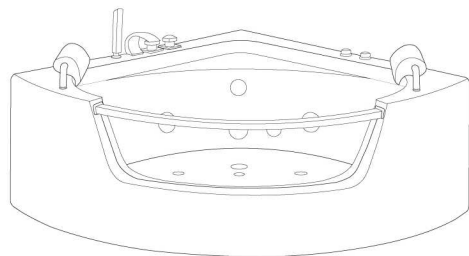

5. Connect the drain pipe with the main drain and install water supply lines.

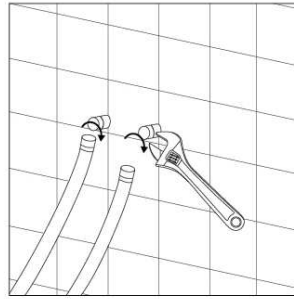

6. Use the silicone gun to caulk the bathtub

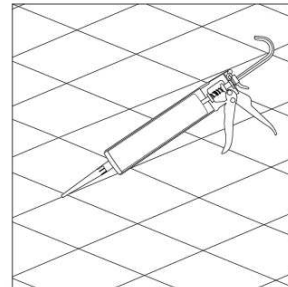

7. Put the bathtub's plug into a socket.

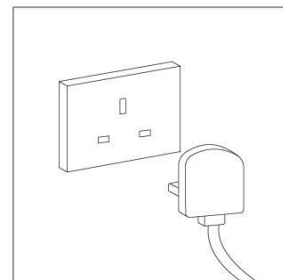

# Suomi (FI)

## LED-valoilla varustetun poreammeen asennusohje

Kiitos että valitsit poreammeemme. Ennen asennusta sinulla tulisi olla:

1. Vesivaaka

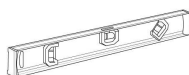

2. Säädettävä ruuviavain



3. Silikonipuristin

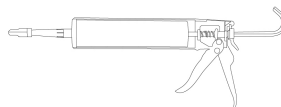

## ASENNUS

1. Aloittaaksesi asennusprosessin ota poreamme ulos pakkauksesta ja varmista että lattia, jolle haluat asentaa poreammeen, on litteä.

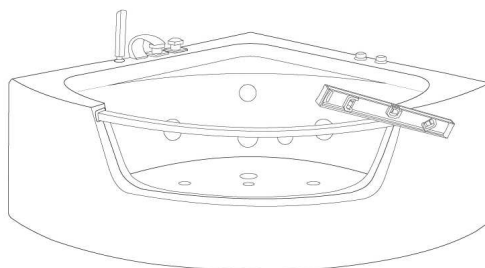

2. Aseta poreamme kulmaan, jonne haluat asentaa sen.

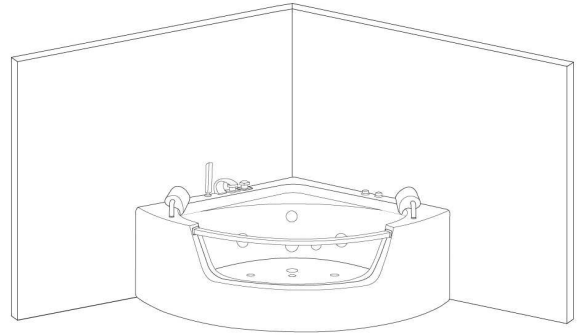

3. Yhdistä ensin hana ja sen jälkeen suihkupää poreammeeseen.

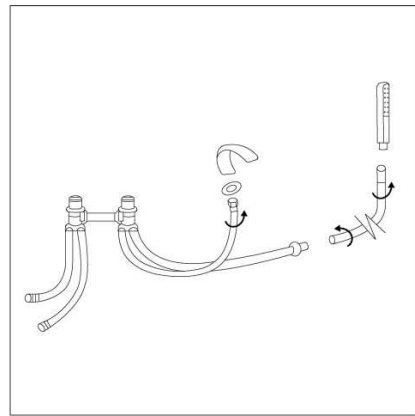

4. Asenna niskatuet.

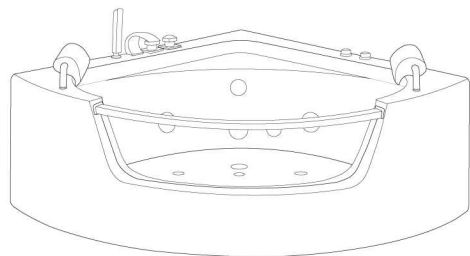

5. Yhdistä tyhjennysputki pääviemäriin ja asenna vedensyöttöputket.

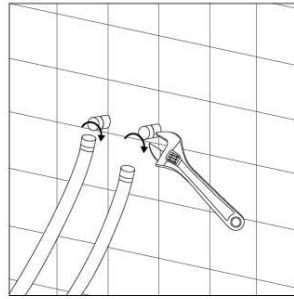

6. Käytä silikonipistoolia kylpyammeen tiivistämiseen.

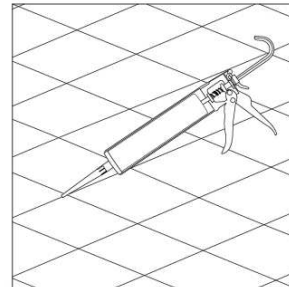

7. Aseta kylpyammeen pistoke pistorasiaan.

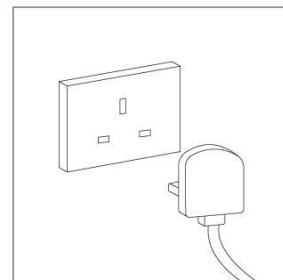

# Français (FR)

## Instructions d'installation de la baignoire balnéo avec LED

Nous vous remercions d'avoir choisi notre baignoire balnéo. Avant l'installation, vous devez avoir :

1. Compteur d'eau

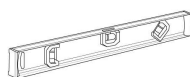

2. Clé à molette



3. Pistolet à silicone

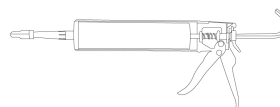

## INSTALLATION

1. Pour commencer le processus d'installation, sortez la baignoire de son emballage et assurez-vous que le sol est plat à l'endroit où vous souhaitez installer la baignoire.

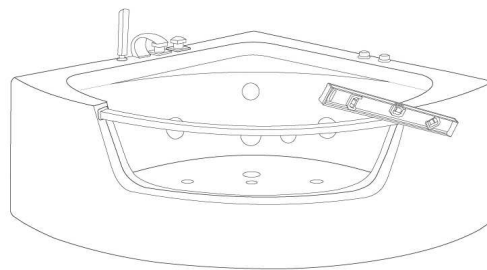

2. Placez la baignoire dans le coin où vous souhaitez l'installer.

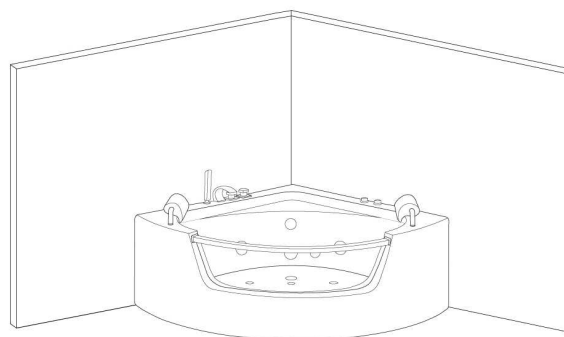

3. Raccordez le robinet puis la douchette à la baignoire.

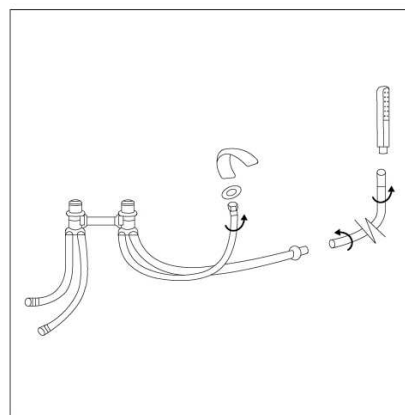

4. Installez les appuis-tête.

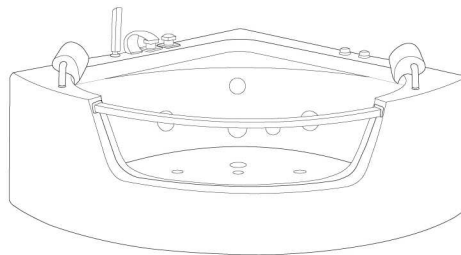

5. Raccordez le tuyau d'évacuation à l'égout principal et installez les conduites d'alimentation en eau.

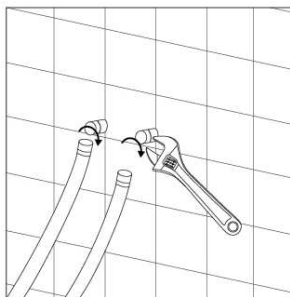

6. Utilisez le pistolet à silicone pour calfeutrer la baignoire

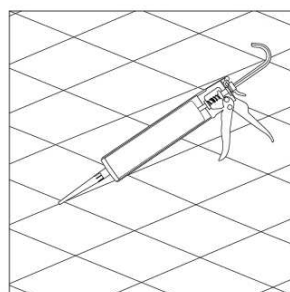

7. Branchez la fiche de la baignoire dans une prise de courant.

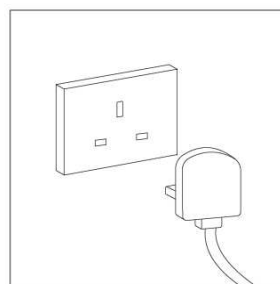

# Deutsch (DE)

## Whirlpool-Badewanne mit LED-Licht Montageanleitung

Vielen Dank, dass Sie sich für unsere Whirlwanne entschieden haben. Für die Installation benötigen Sie:

1. Wasserwaage

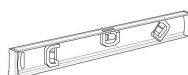

2. verstellbarer Schraubenschlüssel



3. Silikonpistole

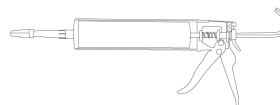

### INSTALLATION DER BADEWANNE

1. Um mit der Installation zu beginnen, nehmen Sie die Badewanne aus dem Karton und vergewissern Sie sich, dass der Boden, auf dem Sie die Badewanne installieren möchten, eben ist.

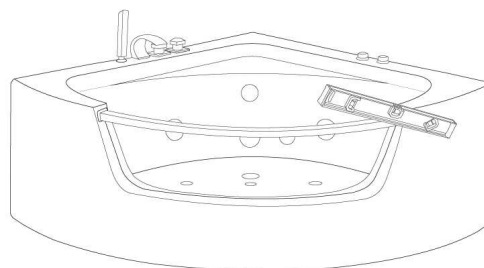

2. Platzieren Sie die Badewanne in der Ecke, in der sie installiert werden soll.

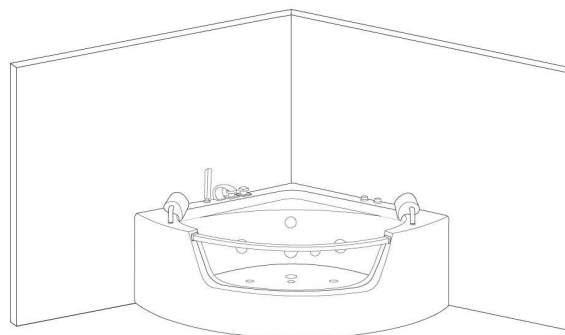

3. Schließen Sie zuerst den Wasserhahn und dann den Duschkopf an die Badewanne an.

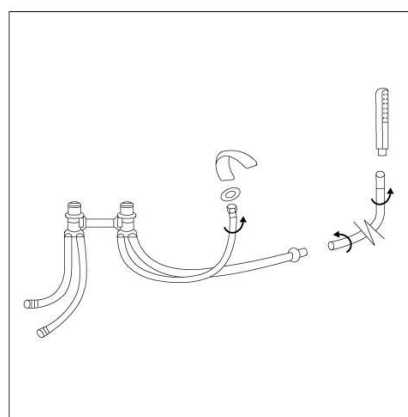

4. Bringen Sie die Kopfstützen an.

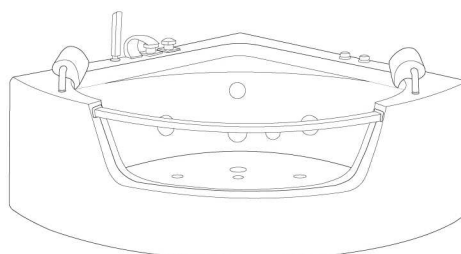

5. Verbinden Sie das Abflussrohr mit dem Hauptabfluss und verlegen Sie die Wasserversorgungsleitungen.

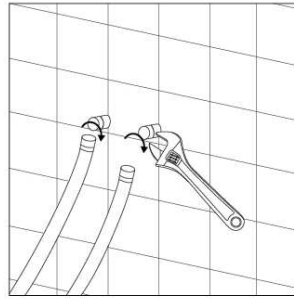

6. Dichten Sie die Ecken und Kanten an der Badewanne mit der Silikonpistole ab.

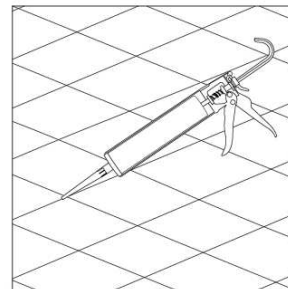

7. Schließen Sie den Stecker der Badewanne an die Steckdose an.

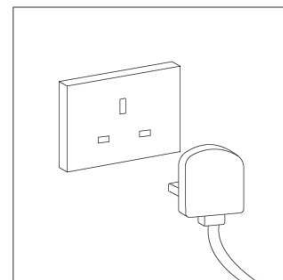

# Magyar (HU)

## Whirlpool Fürdőkád LED világítással összeszerelési útmutató

Köszönjük, hogy fürdőkádunkat választotta. A következőkre lesz szükség az összeszereléshez:

### 1. Vízmérték

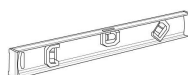

### 2. Csavarkulcs



### 3. Szilikon pisztoly

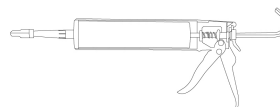

## TELEPÍTÉS

1. A beszerelési folyamat megkezdéséhez vegye ki a kádat a dobozból, és győződjön meg arról, hogy a padló, ahová a kádat be akarja szerelni, sík.

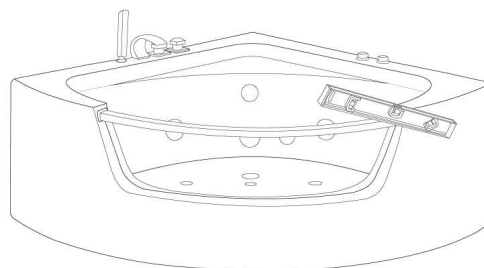

2. Helyezze a kádat abba a sarokba, ahová be akarja szerelni.

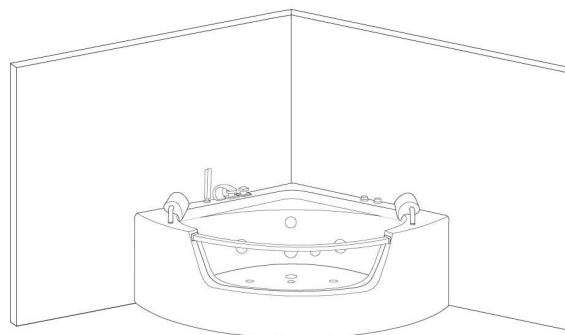

3. Csatlakoztassa a csaptelepet, majd a zuhanyfejet a kádhoz.

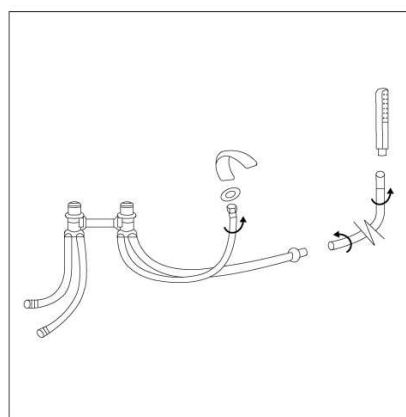

4. Szerelje be a fejtámlákat.

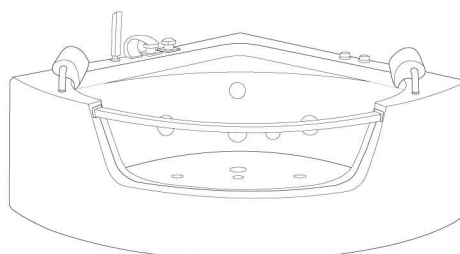

5. Csatlakoztassa a lefolyócsövet a főcsatornához, és szerelje fel a vízvezetékeket.

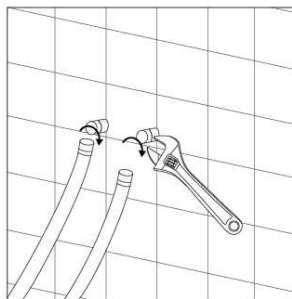

6. Használja a szilikon pisztolyt a kád fugázásához.

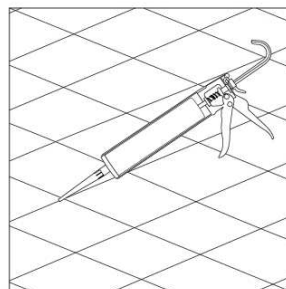

7. Tegye a kád dugaszát egy konnektorba.

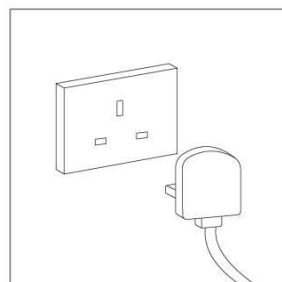

# Italiano (IT)

## Vasca idromassaggio LED Istruzioni per l'installazione:

Grazie per aver scelto la nostra vasca idromassaggio. Prima di iniziare l'installazione, sono necessari:

1. Una Livella a Bolla

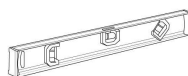

2. Una Chiave Inglese



3. Una Pistola per Silicone

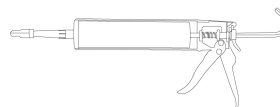

## INSTALLAZIONE

1. Rimuovere la vasca dall'imballaggio e assicurarsi che la superficie scelta per l'installazione sia completamente piana.

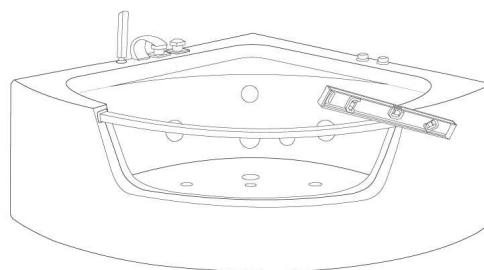

2. Posizionare la vasca nell'angolo desiderato.

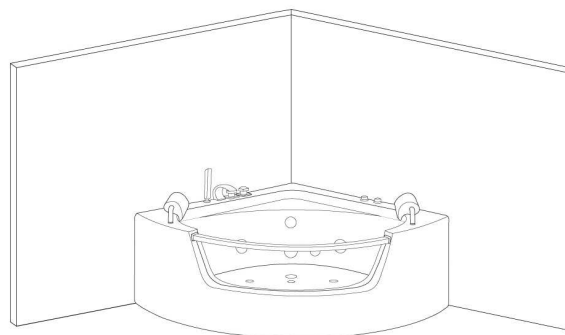

3. Collegare il rubinetto e il soffione della doccia alla vasca da bagno.

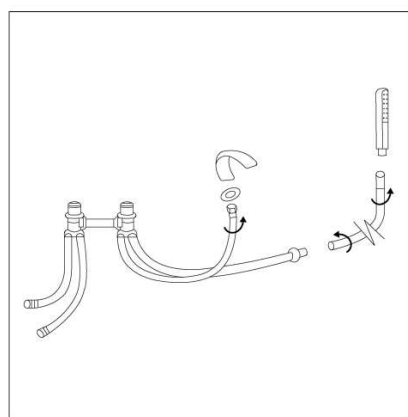

4. Montare i poggiatesta.

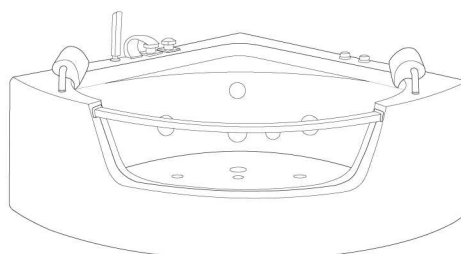

5. Collegare il tubo di scarico al tubo principale e installare i tubi di alimentazione dell'acqua.

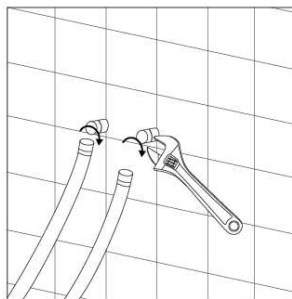

6. Usare la pistola al silicone per fissare la vasca al pavimento.

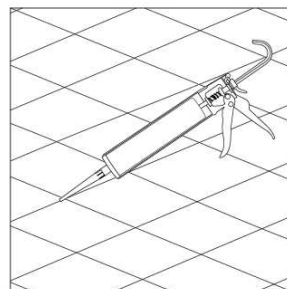

7. Collegare la spina della vasca alla presa di corrente.

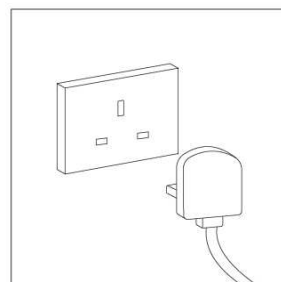

# Norsk (NO)

## Boblebad med installasjonsinstruksjoner for LED-installasjon

Takk for at du valgte boblebadet vårt. Før installasjon bør du ha:

1. Vaterpass

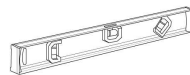

2. Justerbar skiftenøkkel



3. Fugepistol

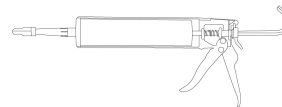

## INSTALLASJON

1. For å starte installasjonsprosessen, ta boblebadet ut av esken og sørg for at gulvet du vil installere badekaret på er flatt.

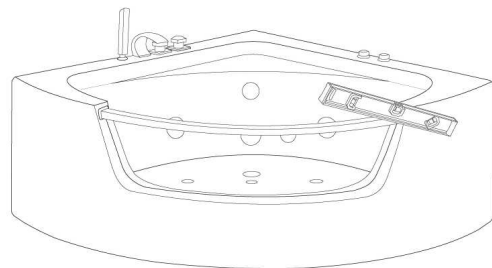

2. Plasser boblebadet i hjørnet, der du vil installere det.

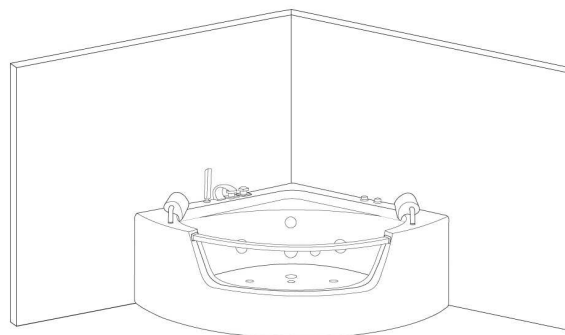

3. Koble kranen og deretter dusjhodet til boblebadet.

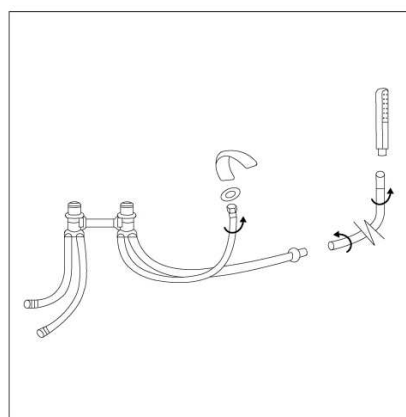

4. Installer nakkestøtter.

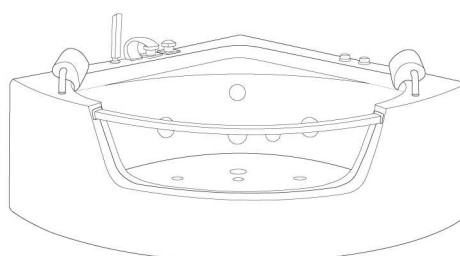

5. Koble avløpsrøret til hovedavløpet og installer vannforsyningsledninger.

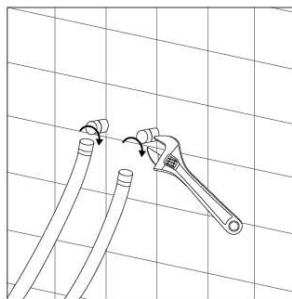

6. Bruk fugepistolen til å tette badekaret.

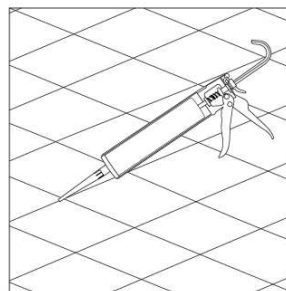

7. Sett støpselet til boblebadet i stikkontakten.

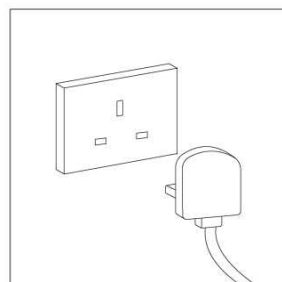

# Polski (PL)

## Instrukcja montażu wanny z hydromasażem

Dziękujemy za wybranie naszej wanny narożnej. Przed jej montażem prosimy o przygotowanie następujących produktów:

1. Poziomica

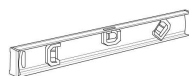

2. Klucz francuski



3. Pistolet do silikonu

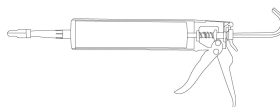

## MONTAŻ

1. Wyciągnij wannę z kartonu, a następnie upewnij się, że podłoga w miejscu, gdzie chcesz ją zamontować, jest równa.

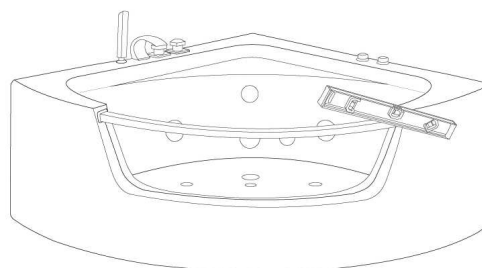

2. Umieść wannę w rogu, w którym zostanie zainstalowana.

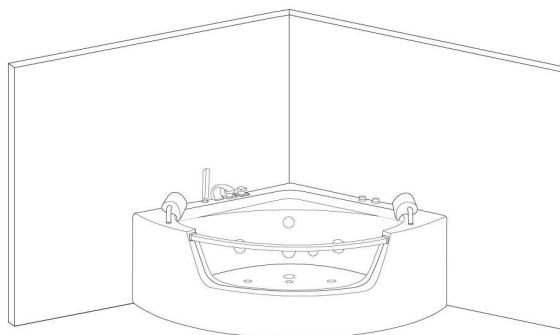

3. Podłącz baterię, a następnie głowicę prysznica do wanny.

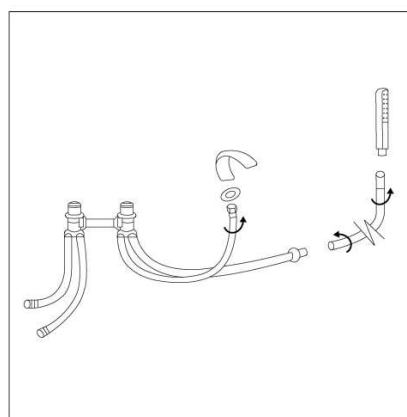

4. Zamontuj zagłówki.

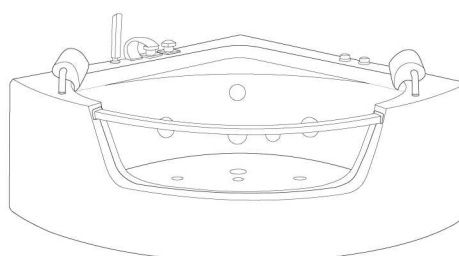

5. Przyłącz wannę do zaworu odpływowego. Podłącz węże do dopływu wody.

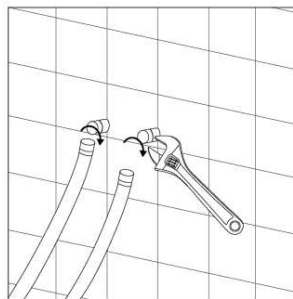

6. Użyj pistoletu do silikonu, aby uszczelnić wannę

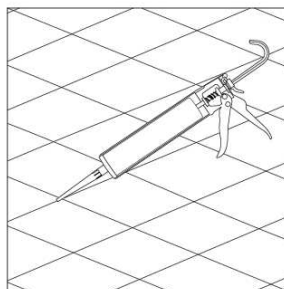

7. Włóż wtyczkę do gniazdka.

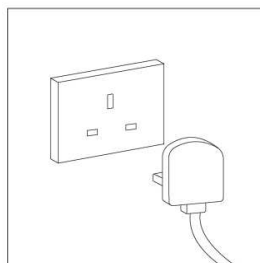

# Português (PT)

## Banheira de hidromassagem com LED - Instruções de montagem

Agradecemos a sua preferência pela nossa banheira de hidromassagem. Antes de começar a montagem, necessita ter:

1. Nível

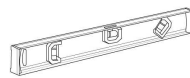

2. Chave inglesa



3. Pistola de silicone

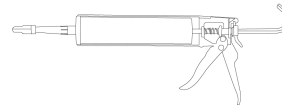

## Montagem

1. Para começar a montagem, retire a banheira da caixa e certifique-se que o chão onde a irá montar é plano.

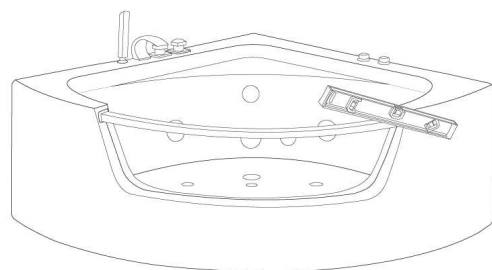

2. Coloque a banheira no canto onde decidiu colocá-la.

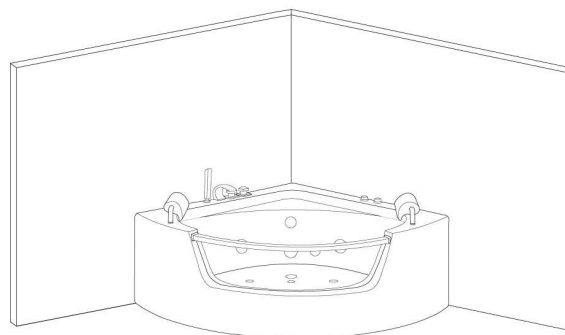

3. Faça a ligação da torneira e, depois, a ligação dos tubos da cabeça do chuveiro à banheira.

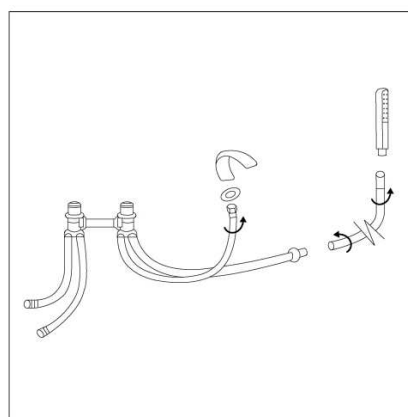

4. Monte os apoios para a cabeça.

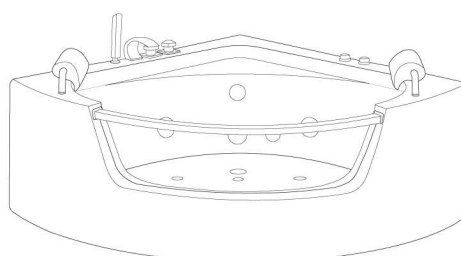

5. Ligue o cano de drenagem da banheira ao cano de drenagem de sua casa e ligue o cano de água da banheira ao ponto de fornecimento de água.

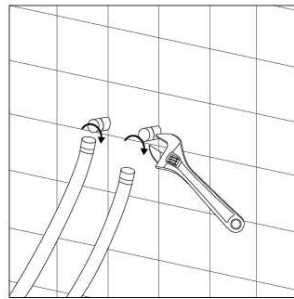

6. Use uma pistola de silicone para fixar a banheira ao chão.

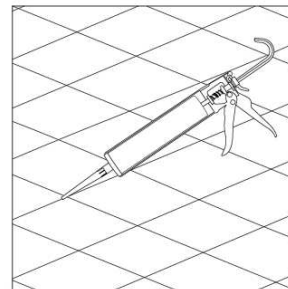

7. Conecte o cabo de alimentação à tomada de energia.

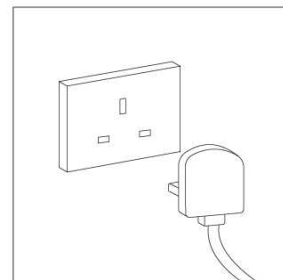

# Español (ES)

## Bañera de hidromasaje LED Instrucciones de instalación

Gracias por elegir nuestra bañera de hidromasaje. Antes de comenzar la instalación, necesitas:

1. Un nivel de burbuja

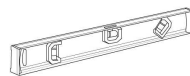

2. Una llave inglesa



3. Una pistola de silicona

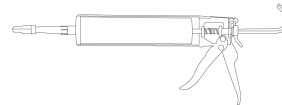

## INSTALACIÓN

1. Retira la bañera de la caja y asegúrate de que la superficie sobre la que deseas instalarla es completamente plana.

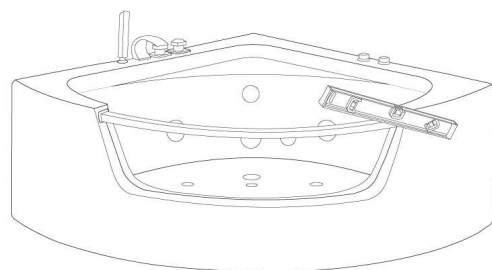

2. Coloca la bañera en la esquina donde quieres instalarla.

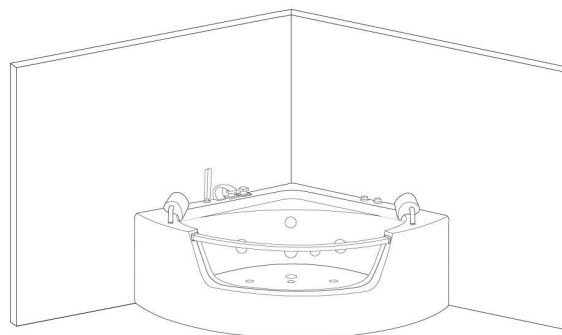

3. Conecta el grifo y la alcachofa de la ducha a la bañera.

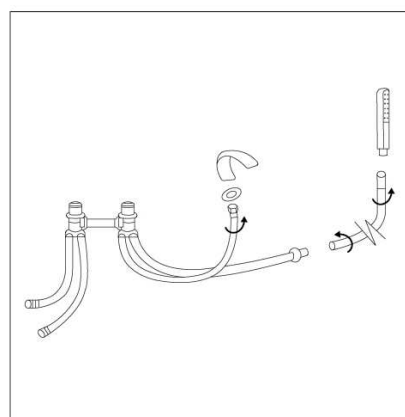

4. Instala los reposacabezas.

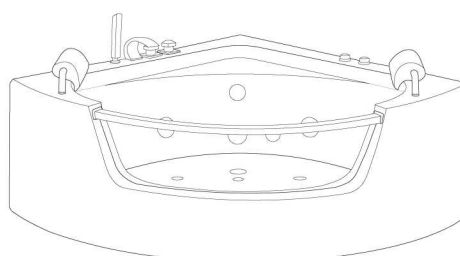

5. Conecta el tubo de desagüe con el principal e instala las tuberías de suministro de agua.

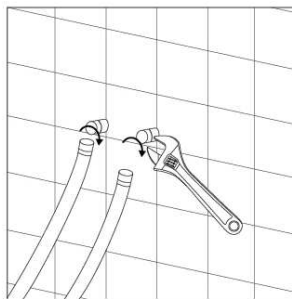

6. Utiliza la pistola de silicona para calafatear la bañera.

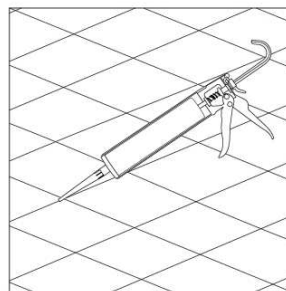

7. Conecta el enchufe de la bañera a la toma de corriente.

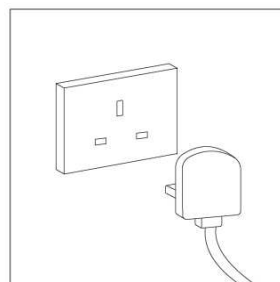

# Svensk (SE)

## Bubbelbadkar med LED-installationsanvisningar

Tack för att du har valt vårt bubbelbadkar. Före installationen bör du ha:

1. Vattenpass

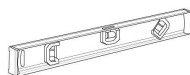

2. Justerbar skiftnyckel



3. Fogspruta

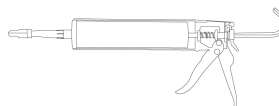

## INSTALLATION

1. För att börja installationsprocessen, ta ut badkaret ur lådan och se till att golvet du vill installera badkaret på är plant.

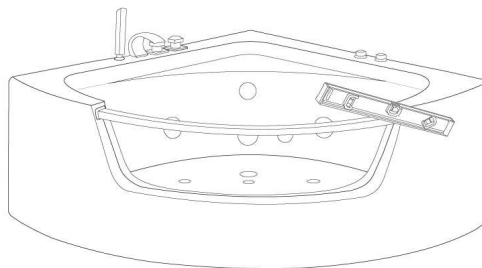

2. Placera badkaret i det hörn där du vill installera det.

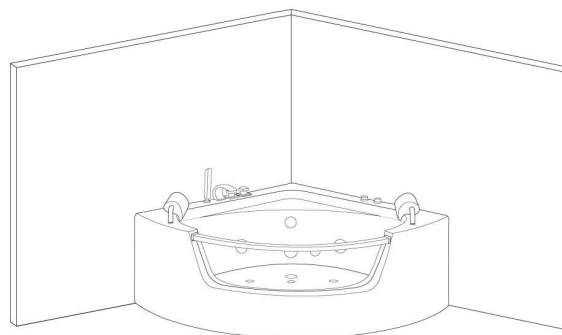

3. Anslut kranen och sedan duschmunstycket till badkaret.

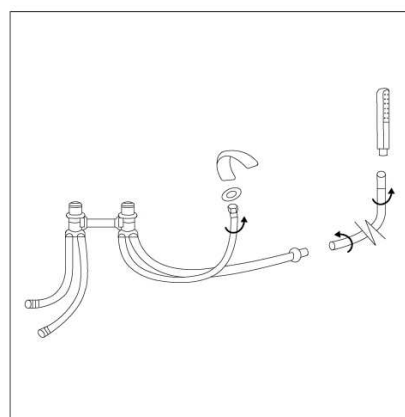

4. Montera på nackstöden.

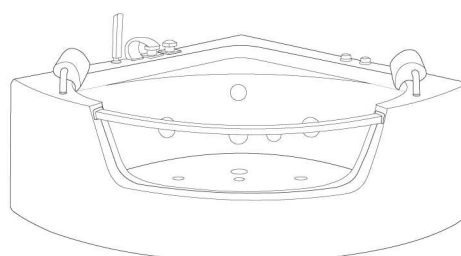

5. Anslut avloppsröret till huvudavloppet och installera vattenledningar.

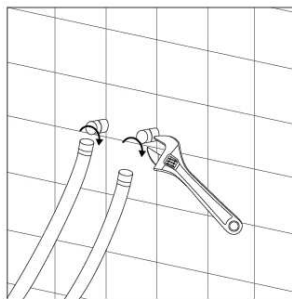

6. Använd fogsprutan för att täta badkaret.

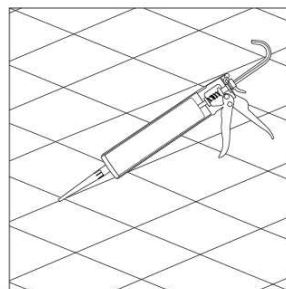

7. Sätt in badkarets stickpropp i uttaget.

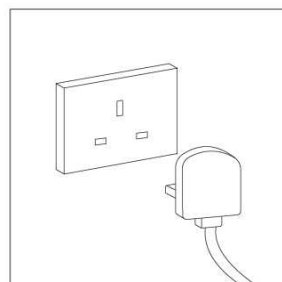

# Slovenčina (SK)

## Návod na inštaláciu hydromasážnej vírivej vane s LED osvetlením

Ďakujeme, že ste si vybrali našu vírivú vaňu. Pred inštaláciou si pripravte:

1. Vodováha

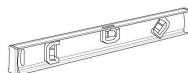

2. Francúzsky kľúč



3. Silikónová pištoľ

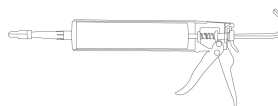

## INŠTALÁCIA

1. Vyberte vaňu z krabice a uistite sa, že podlaha, na ktorú ju chcete umiestniť, je rovná.

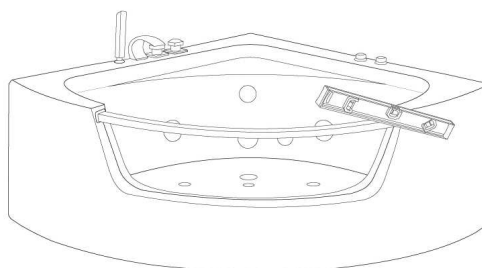

2. Umiestnite vaňu do rohu, do ktorého ju chcete nainštalovať.

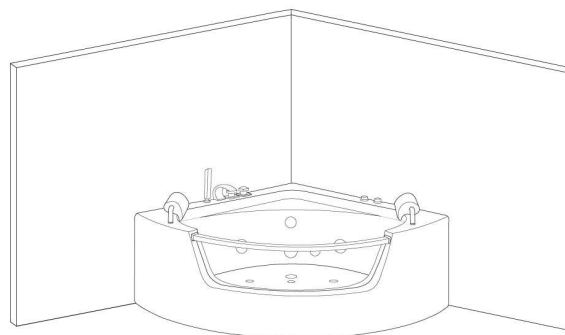

3. Pripojte batériu a následne aj sprchovú hlavicu k vani.

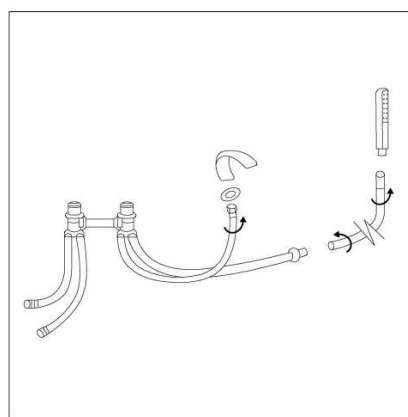

4. Pripevnite opierky hlavy.

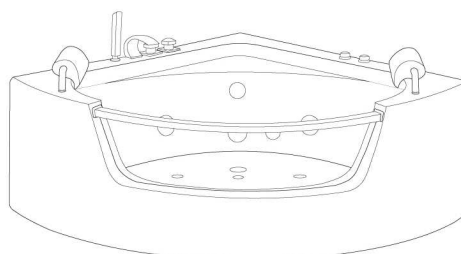

5. Pripojte odtokovú hadicu k vypúšťaciemu ventilu a hadice k prívodu vody.

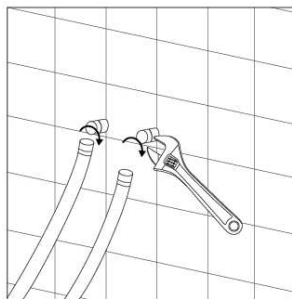

6. Použite silikónovú pištoľ na utesnenie vane.

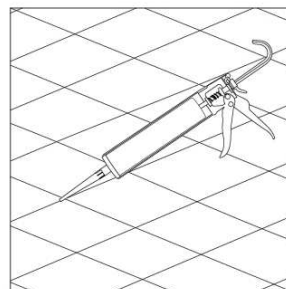

7. Zapojte zástrčku vane do zásuvky.

