

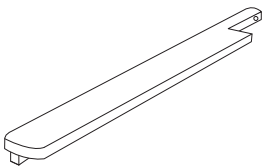

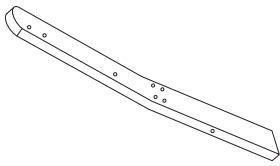

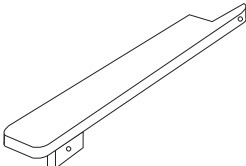

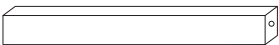

"IMPORTANT, RETAIN FOR FUTURE REFERENCE: READ CAREFULLY"

- ⚠ 1. Gather and organize all required parts prior to assembly.
- 2. Assemble on a flat, clean and soft surface.

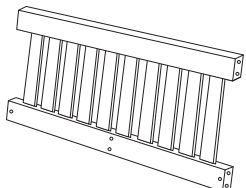
Item no.	Reference Image	Qty.	Item no.	Reference Image	Qty.
1		X1	7		X2
2		X1	A	 M6 X 50MM	X2
3		X2	B	 M6 X 70MM	X18
4		X1	C	 M6 X 70MM	X12
5		X1	D		X1
6		X2	E		X1

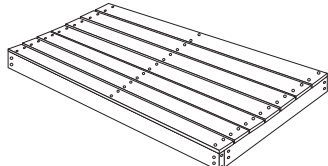
# 1

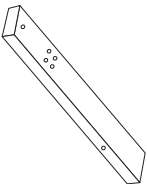
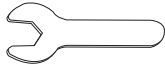
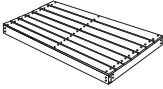
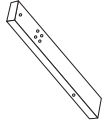
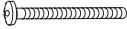
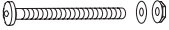
			
⑤ 1pc	⑥ 2pcs	ⓑ 4pcs	ⓒ 4pcs

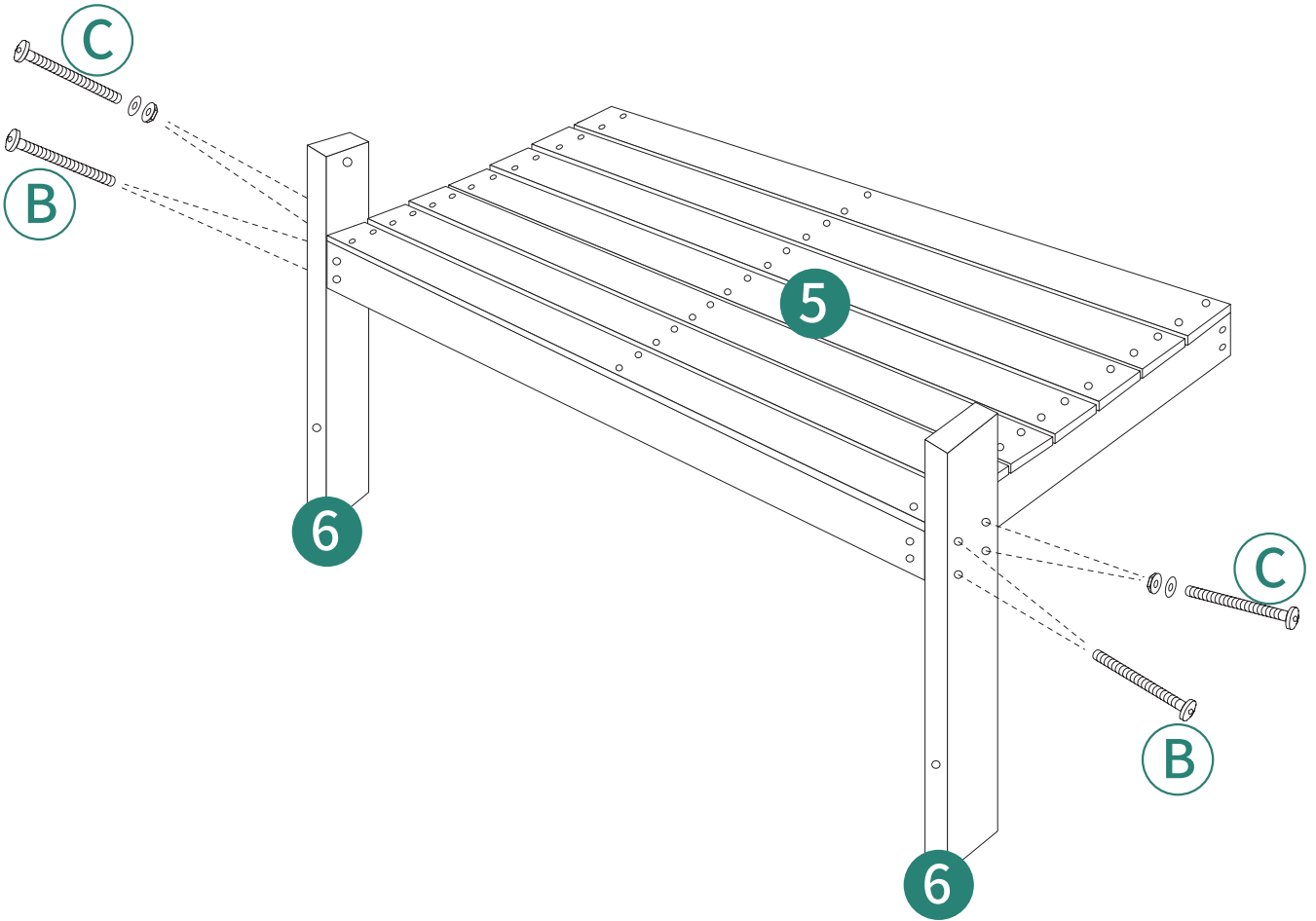

2

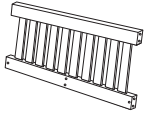

④ 1pc

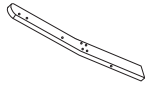

⑦ 2pcs



Ⓐ 2pcs

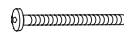

Ⓑ 10pcs



Ⓒ 4pcs

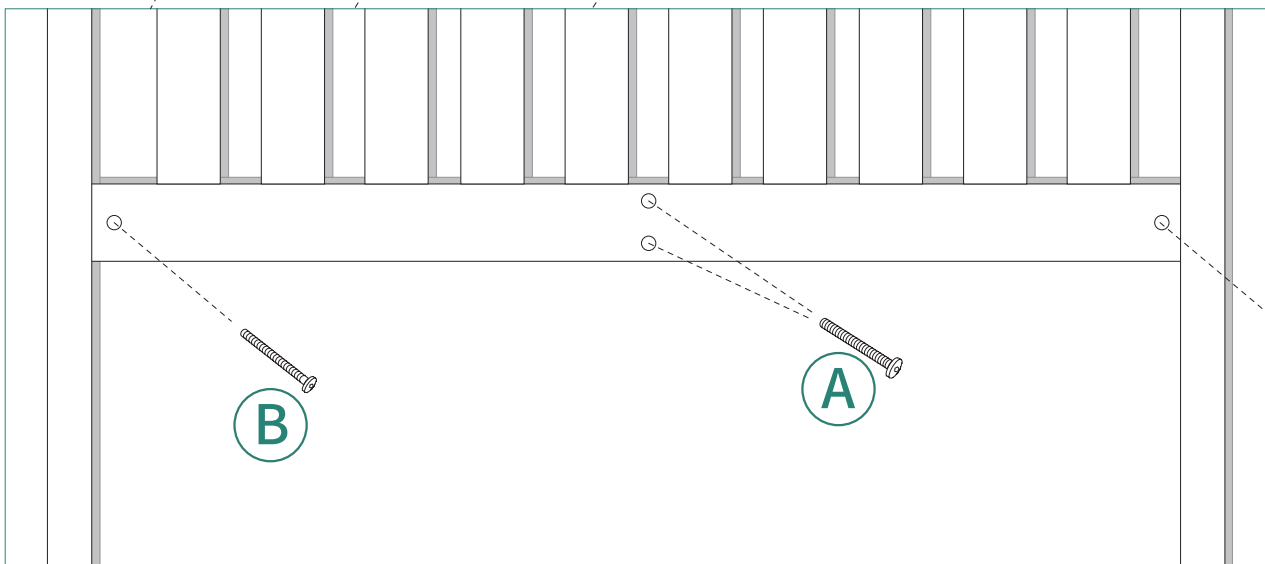
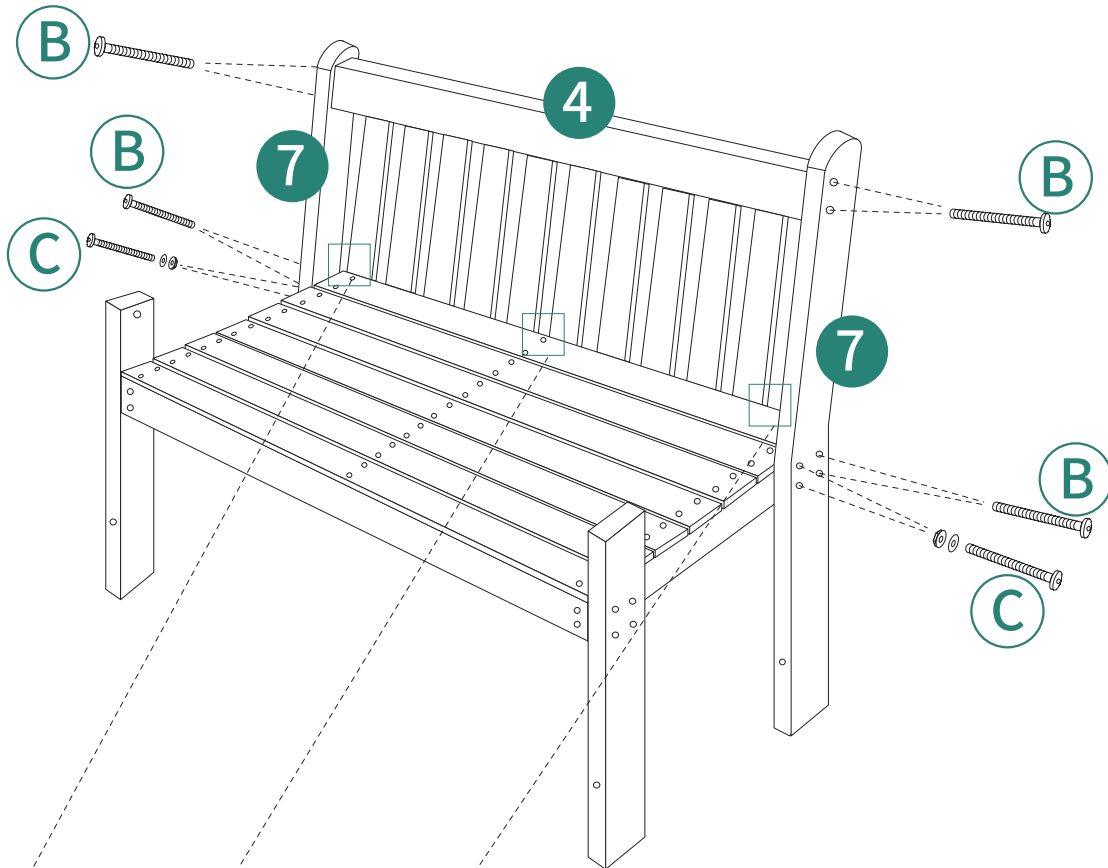

# 3

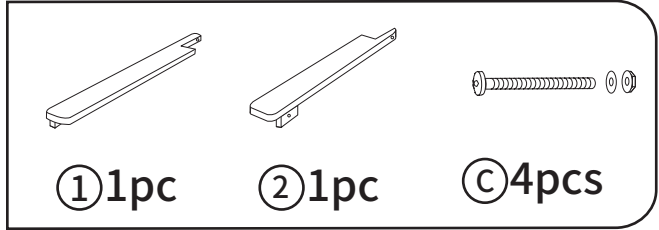

① 1pc      ② 1pc      ③ 4pcs

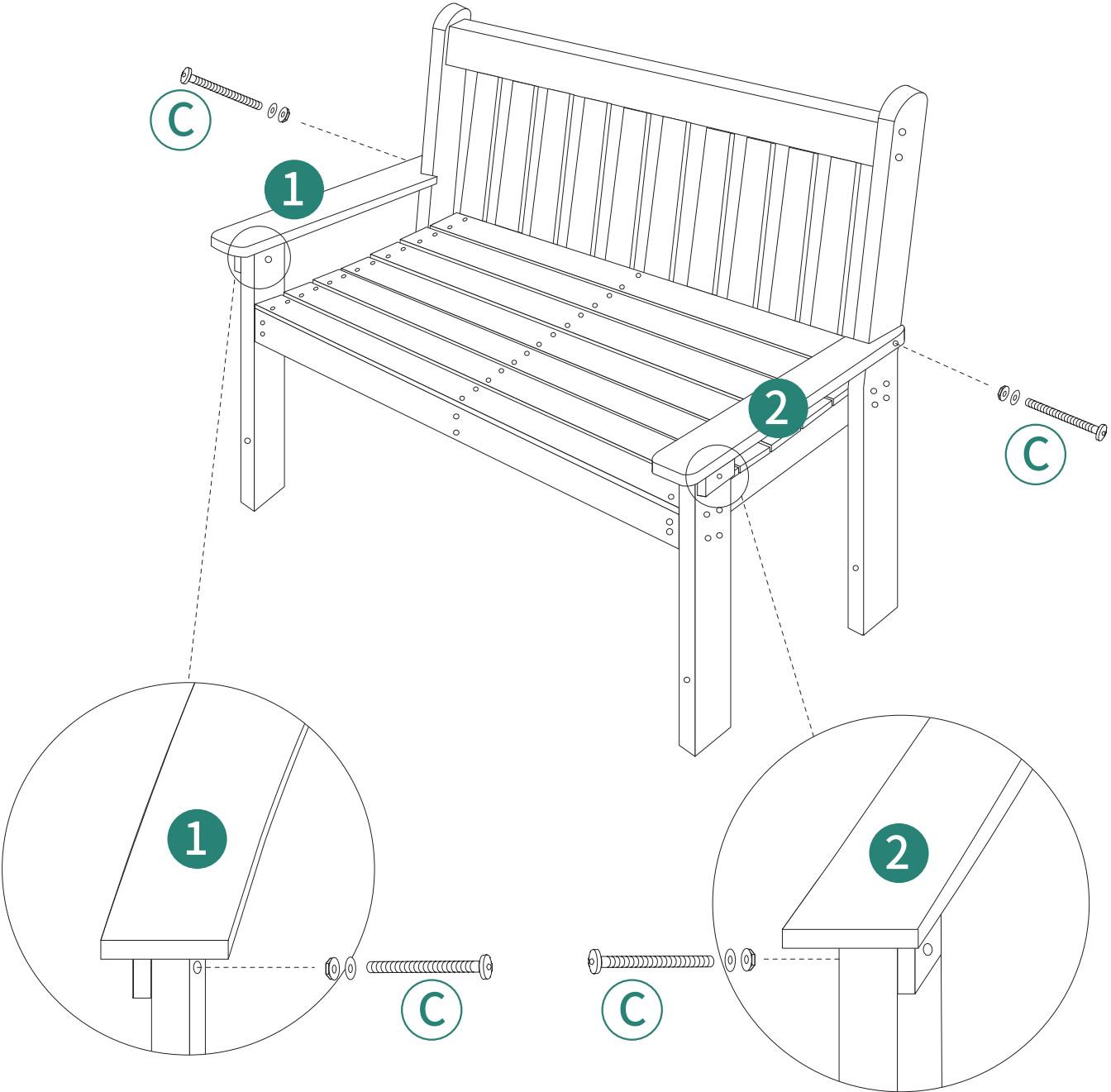

4

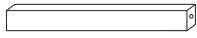

③ 2pcs

Ⓑ 4pcs

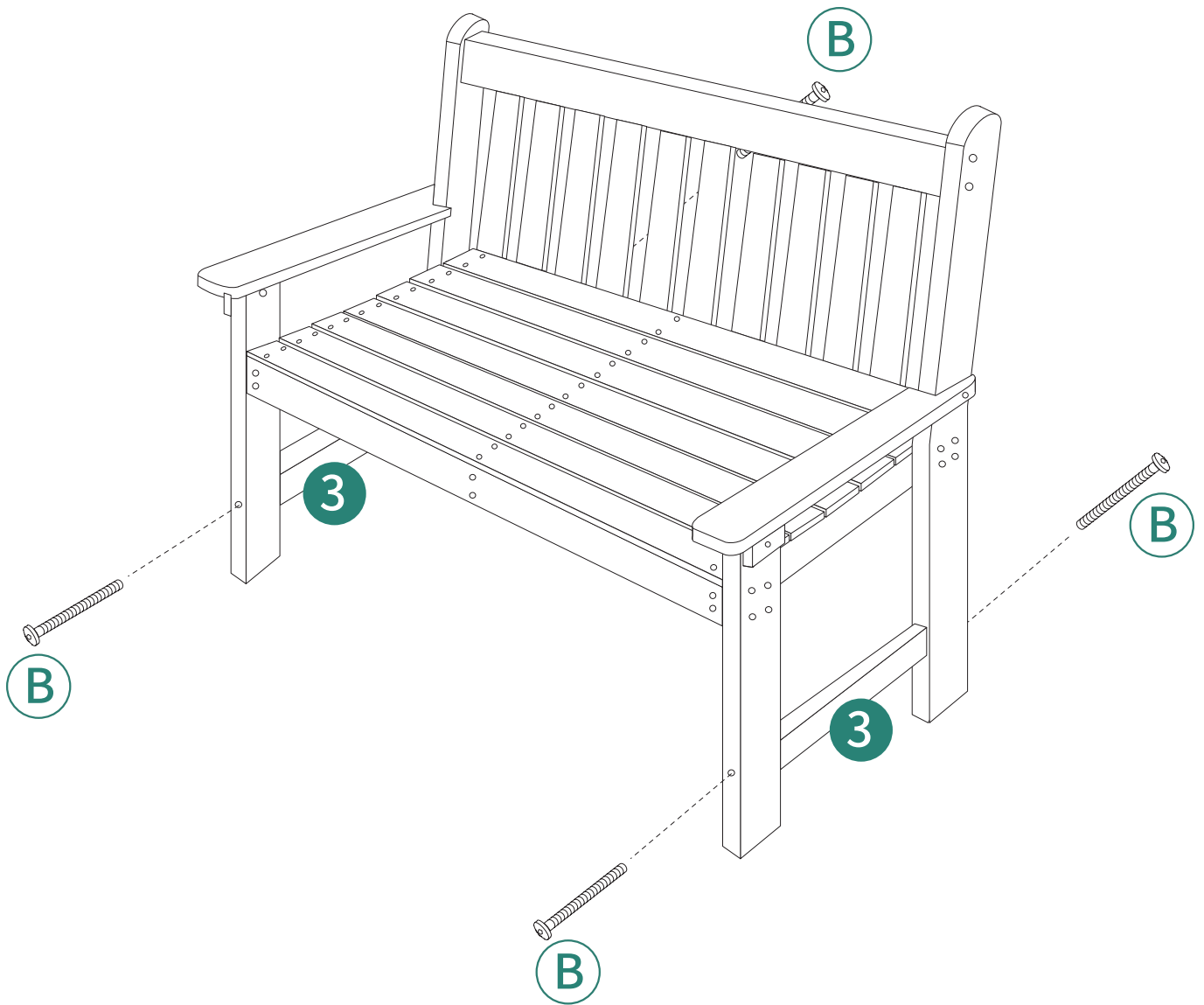

5

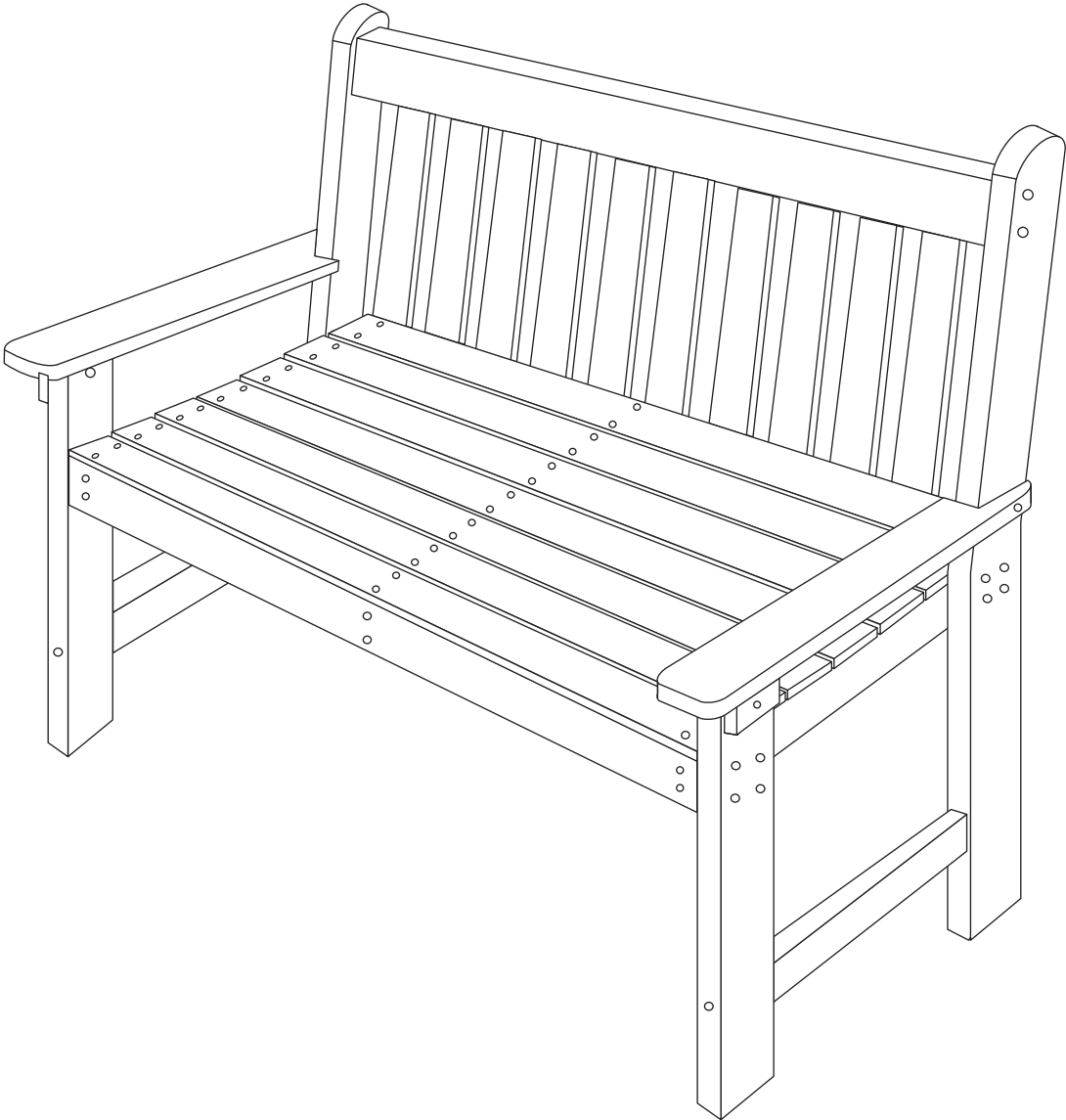

Installation Completed