

ASSEMBLY INSTRUCTIONS

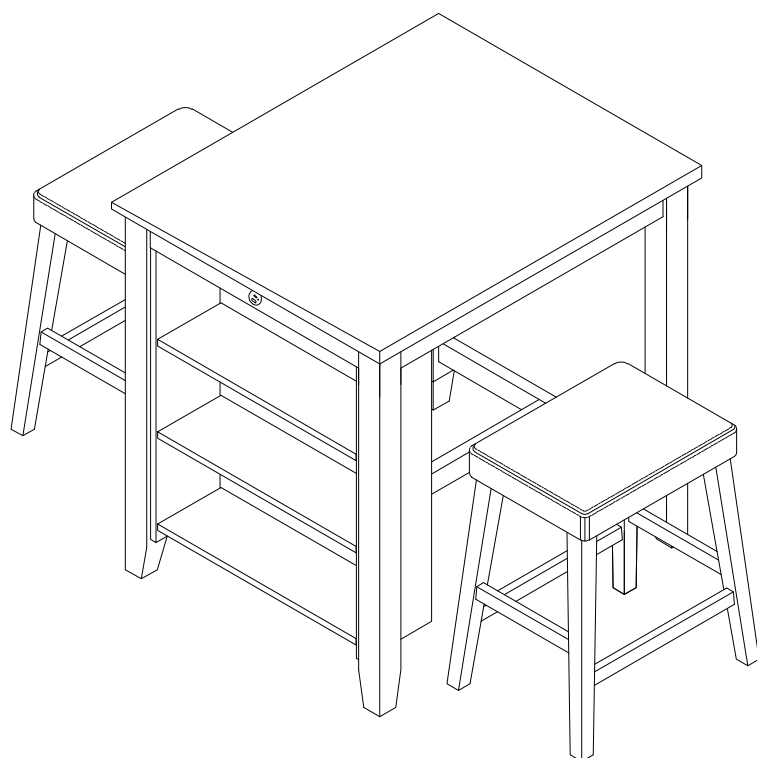

TOOLS REQUIRED

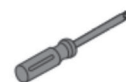

Screwdriver
(Not included)



(Included)
Allen Wrench



2 - People

ASSEMBLY RATING



EASY —————> DIFFICULT

The Assembly Rating is a 5-point system showing the level of effort needed to assemble a specific product.



CHECK BEFORE STARTING

- | | |
|---------------------------------------------------------------------------------------------------------------------------------------------------|------------------------------------------------------------------------------------------------------------------------------------------------------------|
| <input type="checkbox"/> Are you missing anything?
Double-check all parts, hardware and accessories listed are all accounted for. | <input type="checkbox"/> Check out our Quick Tips!
We recommend reviewing the pre-assembly handouts. Even experts need a refresher now and then! |
| <input type="checkbox"/> Should we send any replacements?
Are there any irregularities or flaws in the parts? We can send replacements! | <input type="checkbox"/> Prep Time!
Please review the assembly instructions and all diagrams prior to assembling. |
-

PRE ASSEMBLY INTRODUCTION

We understand building ready-to-assemble furniture can be a challenging experience for some. To help avoid confusion, we have provided some helpful tips that may speed up the process.

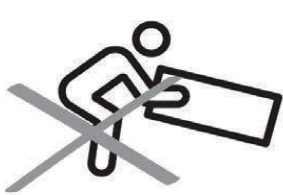

Teamwork

ALWAYS have at least two people to help with transporting and assembling the product to avoid potential injury and/or damage.

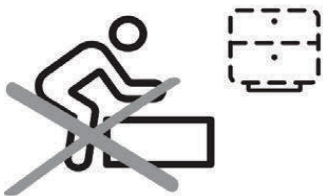

Suitable Location

Assembling near the area of the intended location is highly recommended.



Sufficient Space

Make sure you have enough space to move around during the assembly.



Avoid Scratches

Use cardboard, blankets or a carpeted area while assembling furniture to prevent to prevent scratches and damages.

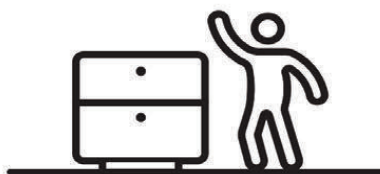
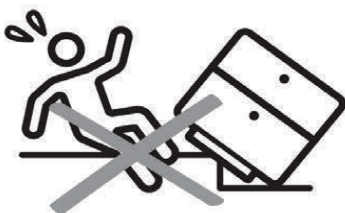

Flat Surface

Make sure the furniture rests on a flat and level surface with each leg evenly touching the floor.

ASSEMBLY AND CARE ADVICE



FAILURE TO FOLLOW THE GUIDELINES BELOW MAY RESULT IN INJURY AND/OR PROPERTY DAMAGE.



Position each part correctly and insert screws or bolts into their respective holes.

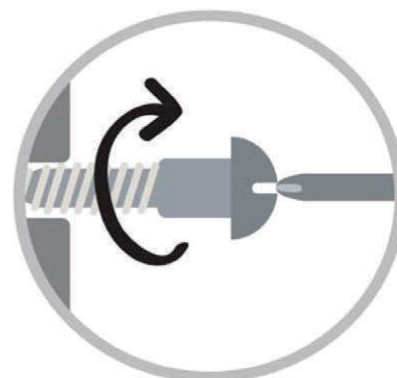

Turn clockwise to tighten and only tighten when step is completed or when instructed to do so.



Use the appropriate hand tools or power tools for assembly. Select steps, such as tightening screws and/or bolts, may require hand tools to avoid causing damage during assembly.



Save the instructions and store any supplied tools for later maintenance.



After two weeks, check and tighten any loose hardware and repeat again every six months thereafter.

IT IS THE USER'S RESPONSIBILITY TO MAINTAIN THE FURNITURE. THE HARDWARE MAY LOOSEN OVER TIME AND MAY CAUSE THE FURNITURE TO BE WOBBLY AND UNABLE TO SUPPORT ITS INTENDED WEIGHT CAPACITY. THIS MAY LEAD TO COLLAPSE AND MAY CAUSE SERIOUS INJURY.

3 PC COUNTER HEIGHT. DINING SET



- Please keep instructions for future reference.
- Check the quantity and irregularity of parts and hardware before you start.

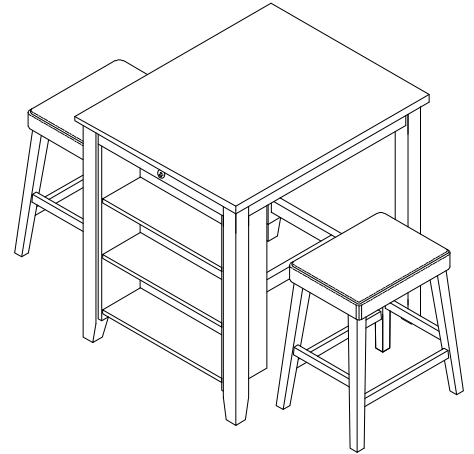

PARTS

1

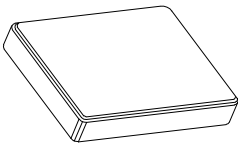

CUSHION SEAT

2 pcs.

2

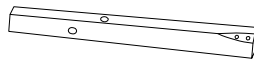

LEFT STOOL LEG

4 pcs.

3

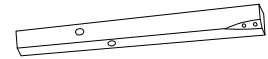

RIGHT STOOL LEG

4 pcs.

4



STOOL SIDE
STRETCHER

4 pcs.

5



STOOL FRONT &
BACK STRETCHER

4 pcs.

6

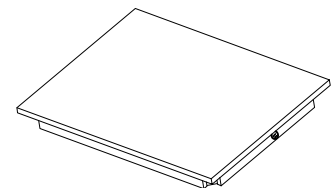
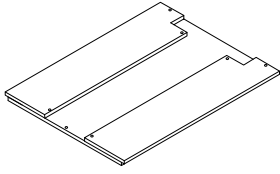

TABLE TOP

1 pc.

7



SIDE PANEL +
BACK PANEL
1 pc.

8

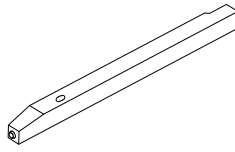

LEFT BACK LEG
1 pc.

9

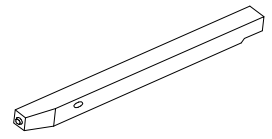

RIGHT BACK LEG
1 pc.

10

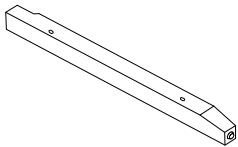

LEFT FRONT LEG
1 pc.

11

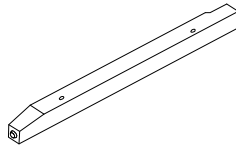

RIGHT FRONT LEG
1 pc.

12

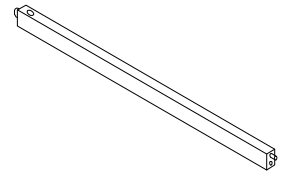

CENTER STRETCHER
1 pc.

13

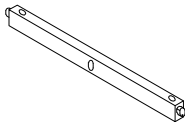

BACK STRETCHER
1 pc.

14

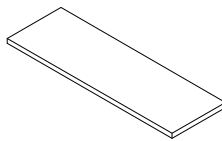

SHELF
2 pcs.

15

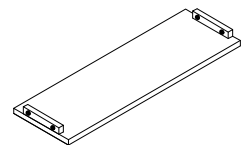

BOTTOM PANEL
1 pc.

STOOL HARDWARE

A

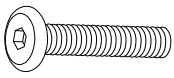

BOLT
Ø1/4" x 2"
8 pcs.

B



SPRING WASHER
Ø1/4"
8 pcs.

C

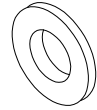

FLAT WASHER
Ø1/4"
8 pcs.

D



SCREW
45mm
16 pcs.

E

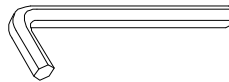

ALLEN WRENCH
M4
1 pc.

TABLE HARDWARE

F

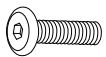

BOLT
Ø1/4" x 1-3/8"
11 pcs.

G

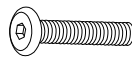

BOLT
Ø1/4" x 2-1/4"
8 pcs.

H



SPRING WASHER
Ø1/4"
19 pcs.

I



FLAT WASHER
Ø1/4"
19 pcs.

J



SCREW
#8 x 2"
3 pcs.

K











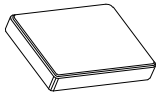
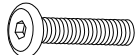
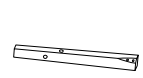







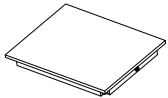
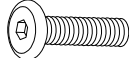
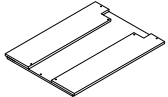
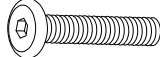
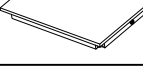

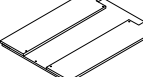

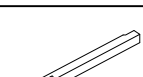
SHELF PIN
8 pcs.

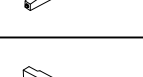
L

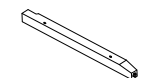

ALLEN WRENCH
M4
1 pc.

Carton	Disignation	Part		
	CUSHION SEAT	1		 A x 8pcs
	LEFT STOOL LEG	2		 B x 8pcs
	RIGHT STOOL LEG	3		 C x 8pcs
	STOOL SIDE STRETCHER	4		 D x 16pcs
	STOOL FRONT & BACK STRETCHER	5		 E x 1pc
	TABLE TOP	6		 F x 11pcs
	SIDE PANEL + BACK PANEL	7		 G x 8pcs
	LEFT BACK LEG	8		 H x 19pcs
	RIGHT BACK LEG	9		 I x 19pcs
	LEFT FRONT LEG	10		 J x 3pcs
	RIGHT FRONT LEG	11		 K x 8pcs
	CENTER STRETCHER	12		 L x 1pc
	BACK STRETCHER	13		
	SHELF	14		
	BOTTOM PANEL	15		

ASSEMBLY INSTRUCTIONS

1

- Part 1 x1pc
- Part 2 x2pcs
- Part 3 x2pcs
- Part 4 x2pcs
- Part 5 x2pcs
- Hardware A x4pcs
- Hardware B x4pcs
- Hardware C x4pcs
- Hardware D x8pcs
- Hardware E x1pc

DO NOT FULLY TIGHTEN ALL BOLTS UNTIL ASSEMBLY IS COMPLETED.

Align legs (2,3) to the cushion seat (1).
Position the stretchers (4,5) onto the legs.
Then secure legs onto the cushion seat (1)
by using bolts (A) with washers (B,C).

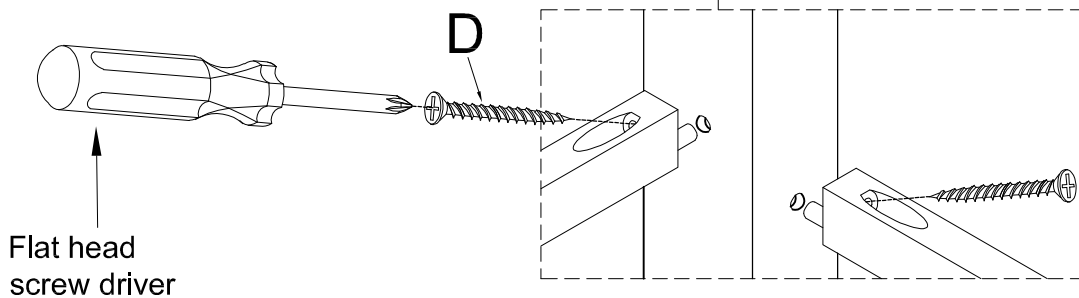
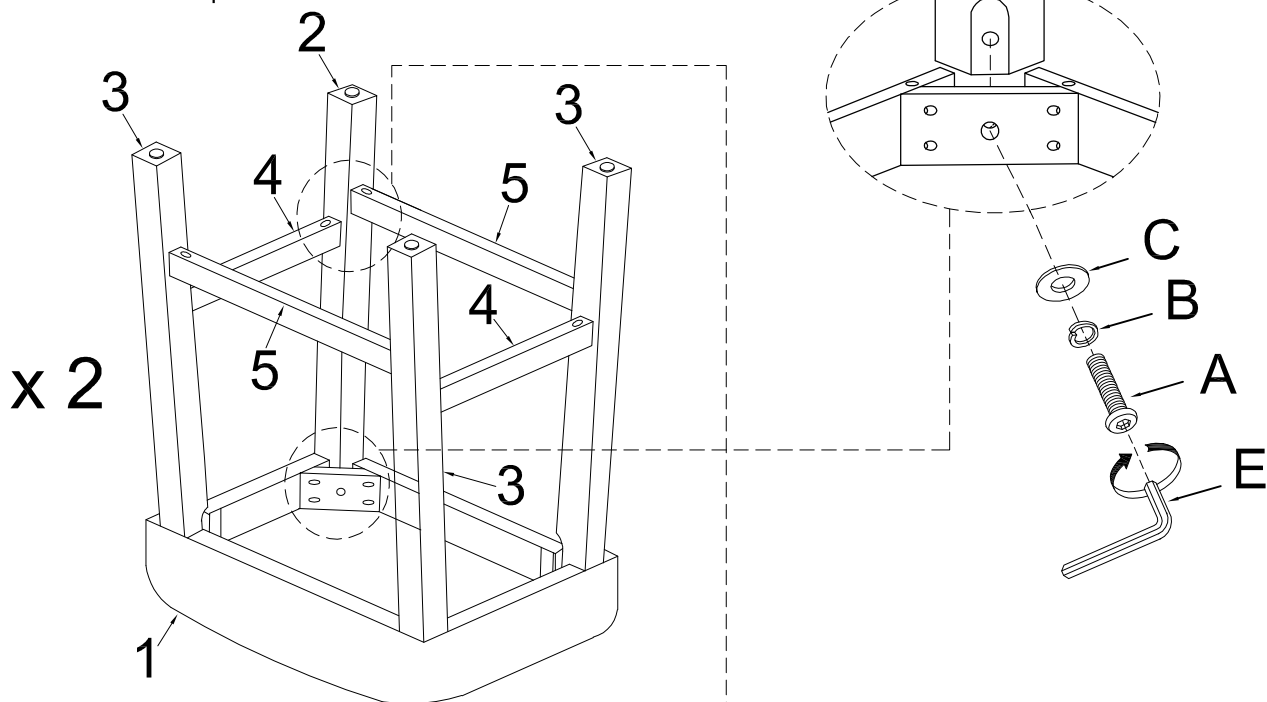

Secure the stretchers (4,5) to the legs (2,3) by using screws (D.)

ASSEMBLY INSTRUCTIONS

2

Part 7 x1pc

Part 15 x1pc

Hardware F x4pcs

Hardware H x4pcs

Hardware I x4pcs

Hardware L x1pc

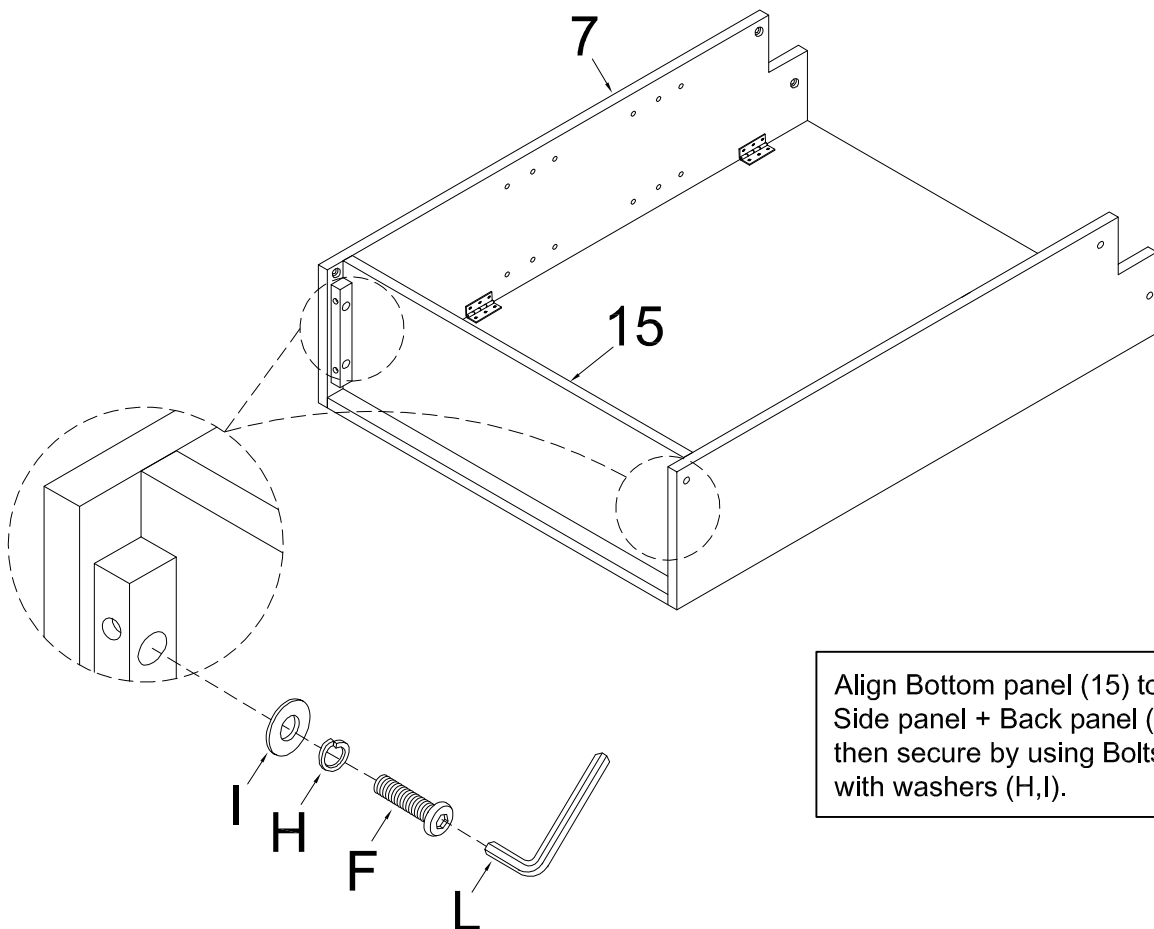
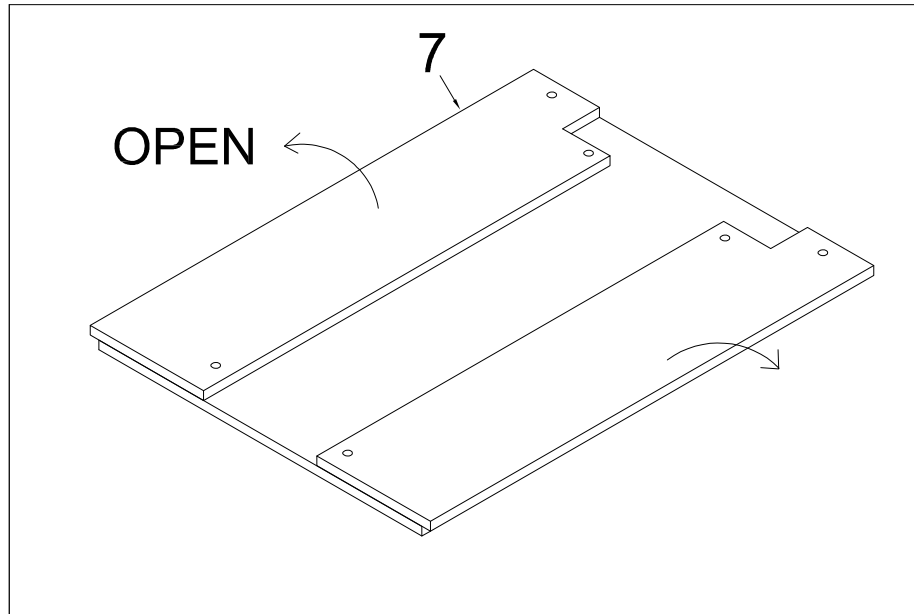

Align Bottom panel (15) to the Side panel + Back panel (7) then secure by using Bolts (F) with washers (H,I).

ASSEMBLY INSTRUCTIONS

3

- Part 6 x1pc
- Part 10 x1pc
- Part 11 x1pc
- Hardware G x4pcs
- Hardware H x4pcs
- Hardware I x4pcs
- Hardware L x1pc

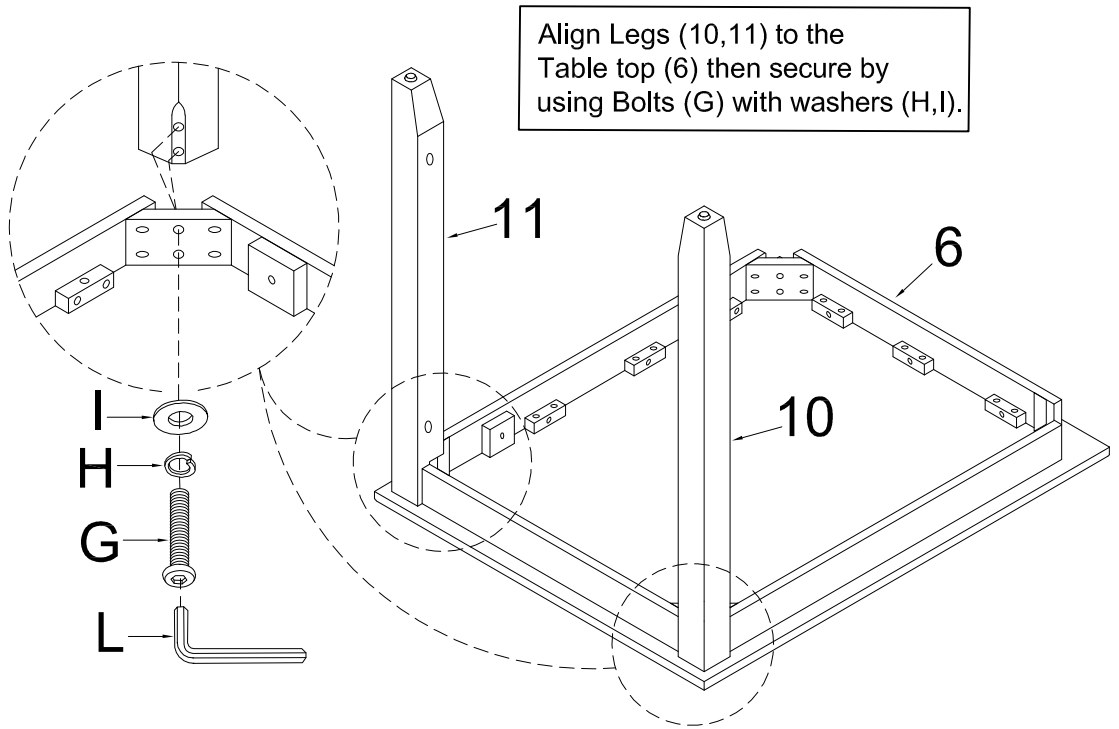

4

- Hardware F x6pcs
- Hardware H x6pcs
- Hardware I x6pcs
- Hardware L x1pc

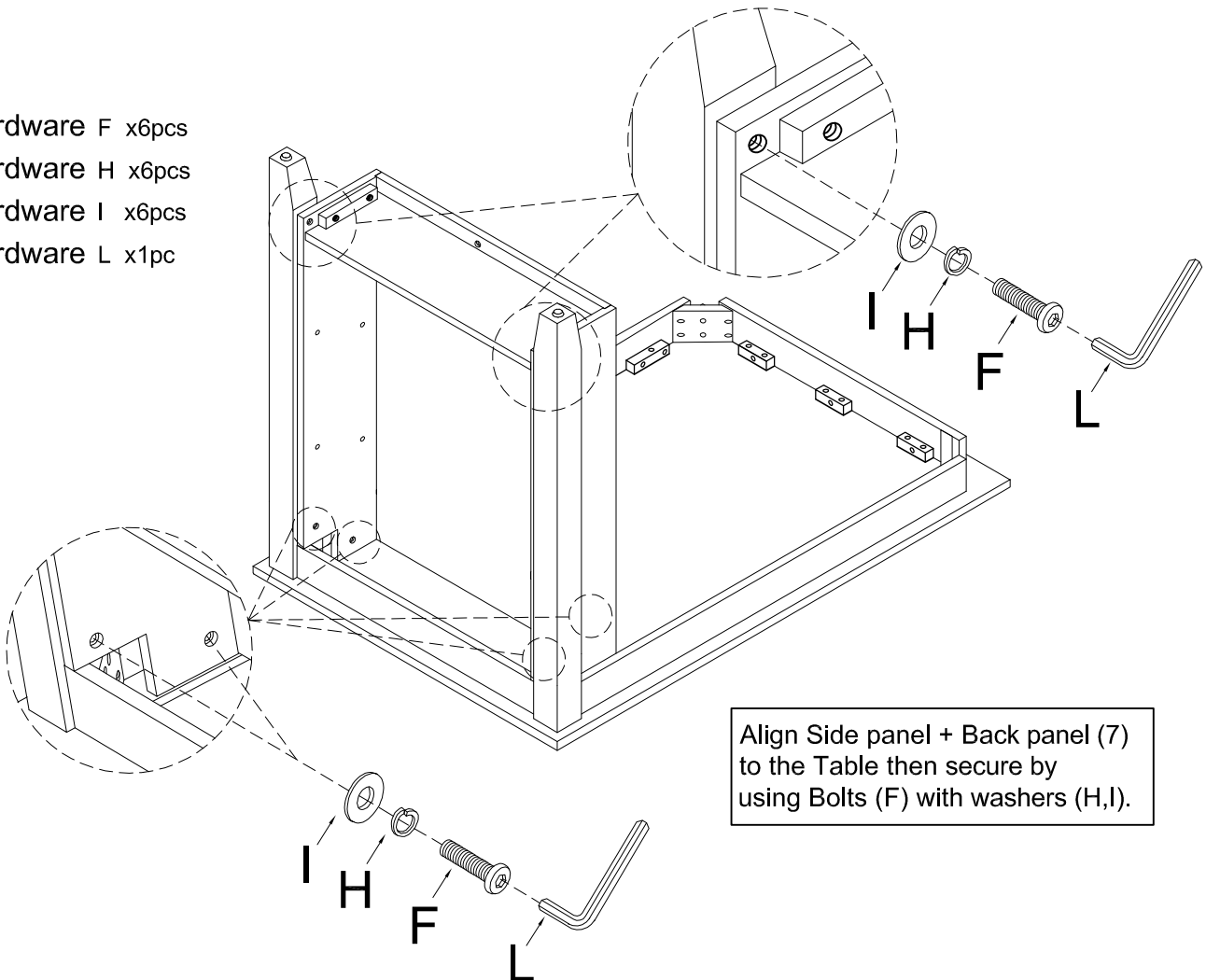

ASSEMBLY INSTRUCTIONS

5

Part 9 x1pc

Hardware G x2pcs

Hardware H x2pcs

Hardware I x2pcs

Hardware L x1pc

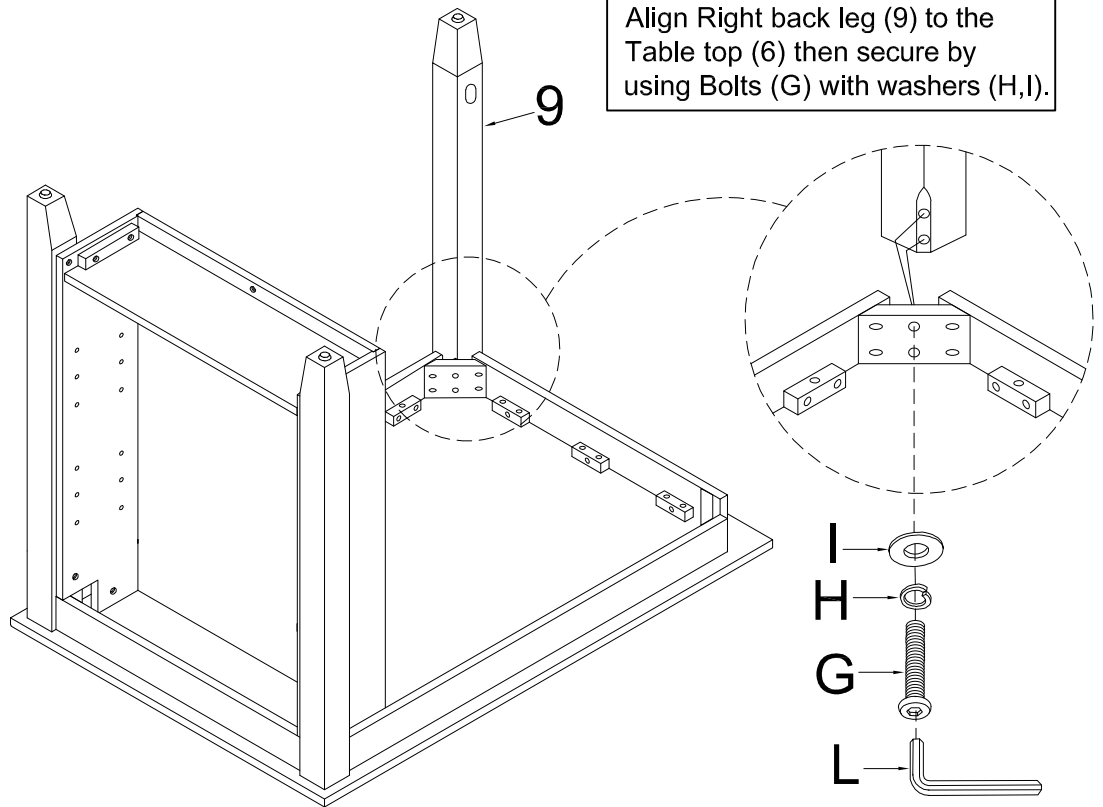

6

Part 12 x1pc

Part 13 x1pc

Hardware F x1pc

Hardware H x1pc

Hardware I x1pc

Hardware J x1pc

Hardware L x1pc

Flat head
screw driver

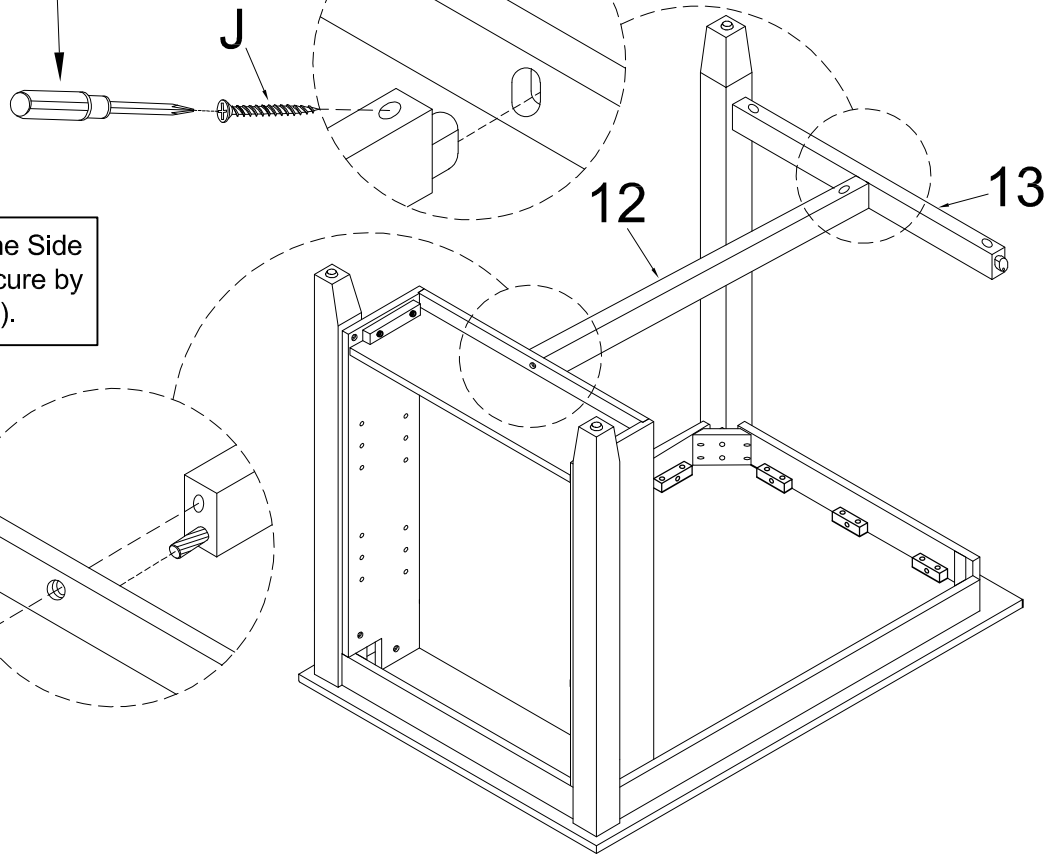

ASSEMBLY INSTRUCTIONS

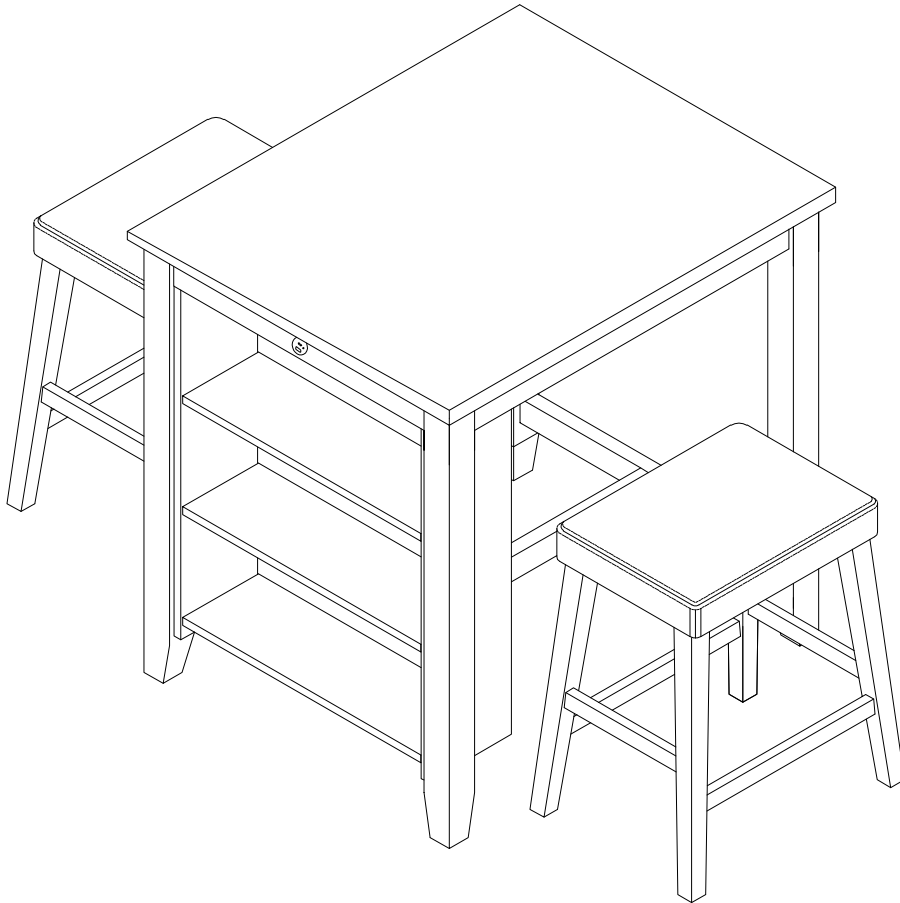

ASSEMBLY COMPLETED



Please ensure the furniture rests on an even and flat surface. If the product wobbles or feels loose, double-check all bolts and/or screws are properly tightened and secured.



Keep this handy!

Please retain this instruction manual and any order-related information for future reference.



Lift, don't drag!

To avoid damage to product please always LIFT the product when transporting or adjusting the placement.

This product is intended for RESIDENTIAL USE ONLY and not for commercial use.