

CURVED FLOOR SOFA-2 SEATER

Assembly Instruction

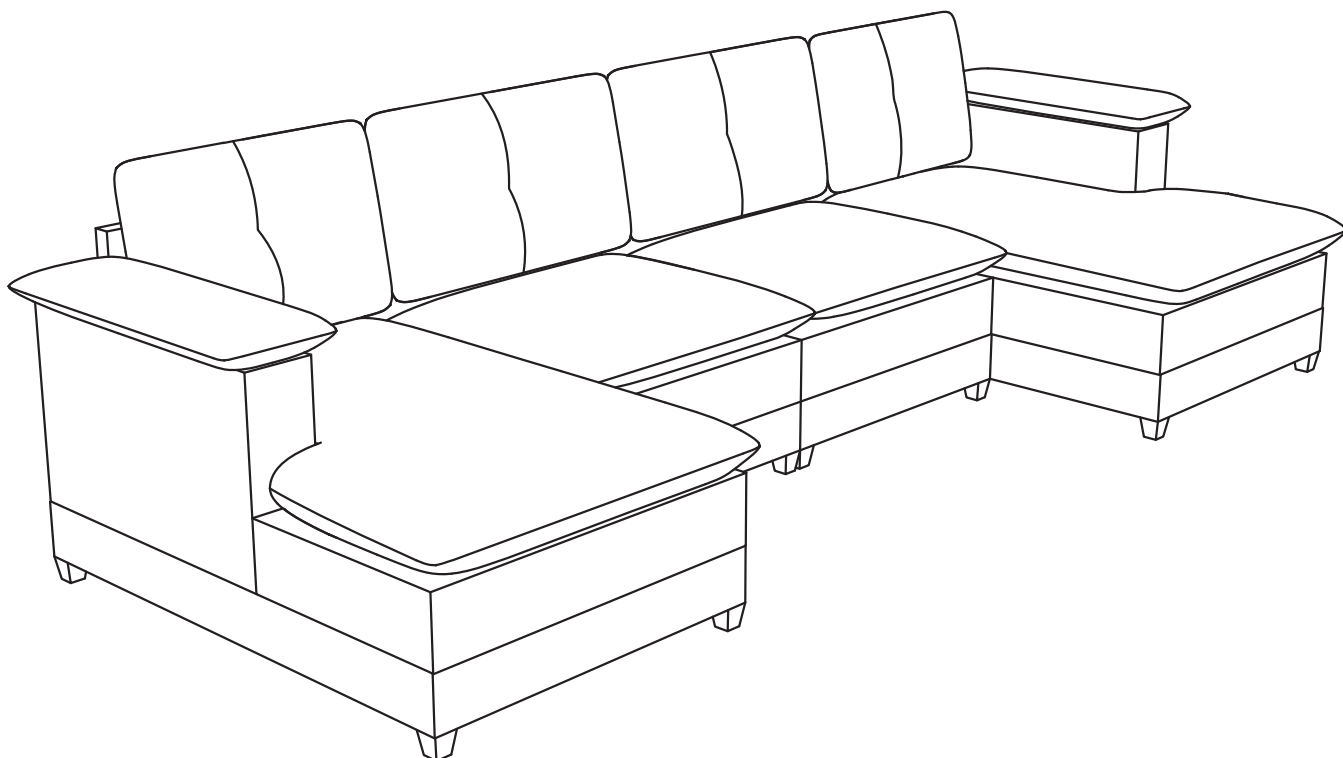

NOTE:

Comes with MULTIPLE PACKAGES
with MULTIPLE TRACKINGS, may not
be delivered at the same time.



Safety and Care Advice

Important – Please read these instructions fully before starting assembly

Thanks for your purchase. Before the assembly. Please follow the instruction to check if all the spare parts and screws are intact.

- Considering the size and weight of the sofa, we recommend two adults to assemble the sofa, on a carpeted or padded area, in the room that it is intended for. Approximate assembly time: 30 minutes.
- Please do not throw away any of the packaging or the instruction until you have checked all the components and hardware and the furniture is fully assembled. Please ensure that the packaging is disposed of in a safe and environmentally friendly way.
- Keep all components and packaging out of reach of children or animals to avoid risk of choking or suffocation.
- Please do not take off the cover, and do not wash.

Your cushions come vacuum packed and sealed for shipping. To restore the cushion's original shape, follow the steps below.

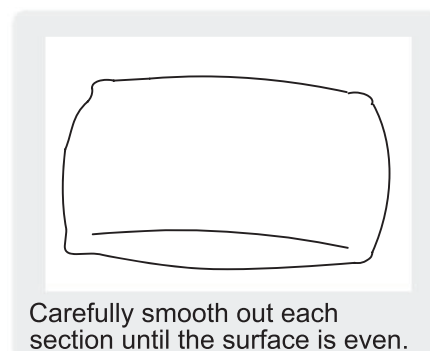
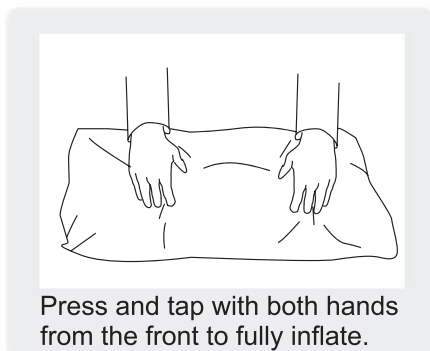
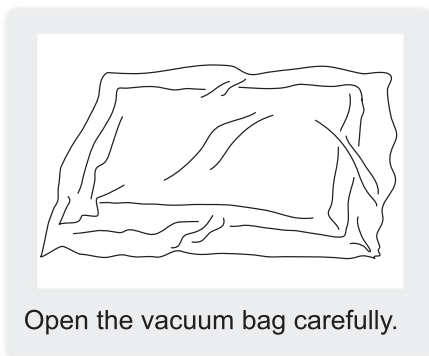

After packing up, place them in somewhere dry and ventilated. After about 72-96 hours, it can be restored to the best use condition.

Seller's Notice:

Our product is packed in separate boxes as shown below, and they might be shipped in different batches. Please wait until you received all the boxes then start the assembly.

Noted: Assembly instruction is only provided in Box1.

The following is the list of components contained in these boxes.

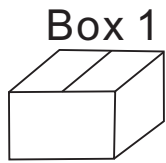

Main structure accessories

(A)		Chaise frame(Left)	X1
(D)		Chaise cushion(Left)	X1
(L)		Backrest	X2
(J)		Armrest bag	X2

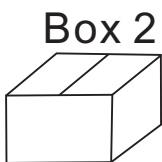





Main structure accessories

(C)		Chaise frame(Right)	X1
(F)		Chaise cushion(Right)	X1
(L)		Backrest	X2
(M)		Back Cushion	X1

Structure accessories

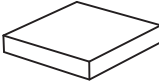
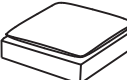
(O)		Sofa Leg 5CM	X12
-----	--	-----------------	-----

Main structure accessories



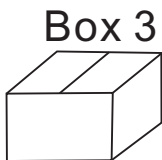

(B)		Single seat frame	X2
(E)		Single seat cushion	X2
(H)		Armrest(Left)	X1
(I)		Armrest(Right)	X1
(M)		Back Cushion	X3
(K)		Back Cover	X1



Structure accessories

(O)		Sofa Leg 5CM	X4
-----	---	-----------------	----







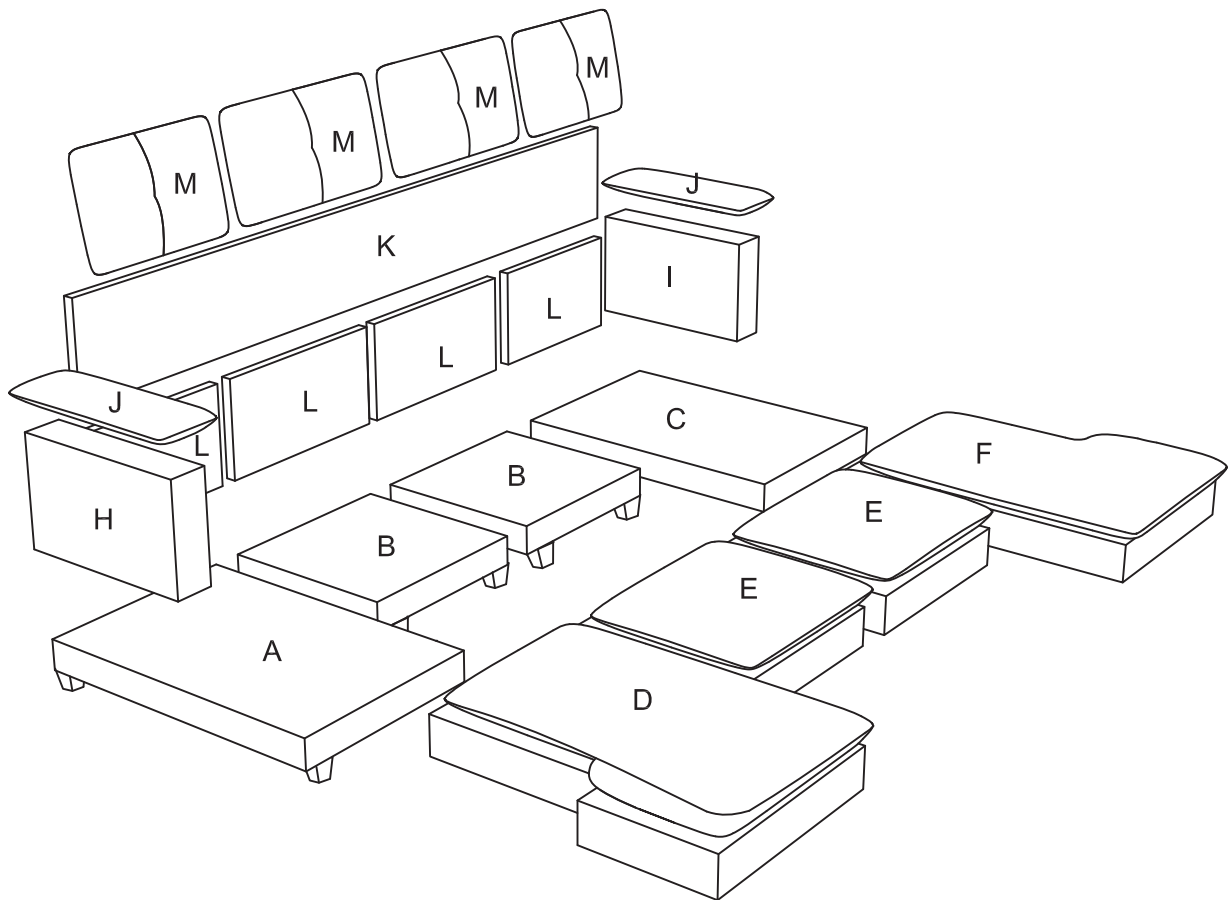

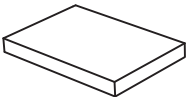
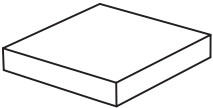
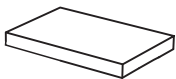
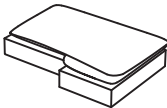
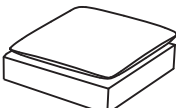

Hardware parts

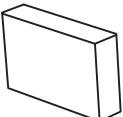
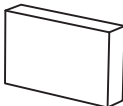
(P)		Connector	X4
(Q)		Washer	X16
(R)		Bolt M8*60	X16
(S)		Gasket	X16
(T)		Allen Key	X1

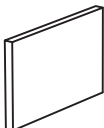
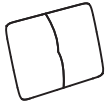
Assembly Instruction of Sofa



PART LIST & HARDWARE



<p>(A) Chaise frame(Left)</p>  <p>X1</p>	<p>(B) Single seat frame</p>  <p>X2</p>	<p>(C) Chaise frame(Right)</p>  <p>X1</p>	<p>(D) Chaise cushion(Left)</p>  <p>X1</p>	<p>(E) Single seat cushion</p>  <p>X2</p>
<p>(F) Chaise cushion(Right)</p>  <p>X1</p>	<p>(H) Armrest(Left)</p>  <p>X1</p>	<p>(I) Armrest(Right)</p>  <p>X1</p>	<p>(J) Armrest bag</p>  <p>X2</p>	<p>(K) Back Cover</p>  <p>X1</p>
<p>(L) Backrest</p>  <p>X4</p>	<p>(M) Back Cushion</p>  <p>X4</p>	<p>(O) Sofa Leg 5CM</p>  <p>X16</p>	<p>(P) Connector</p>  <p>X4</p>	<p>(Q) Washer</p>  <p>X16</p>
<p>(R) Bolt M8*60</p>  <p>X16</p>	<p>(S) Gasket</p>  <p>X16</p>	<p>(T) Allen Key</p>  <p>X1</p>		

Note: Please retain all boxes until you are certain that your product isn't damaged and that you do not wish to return it. Disposal of boxes may prevent our ability to resolve your request.

Assembly Instruction of Sofa

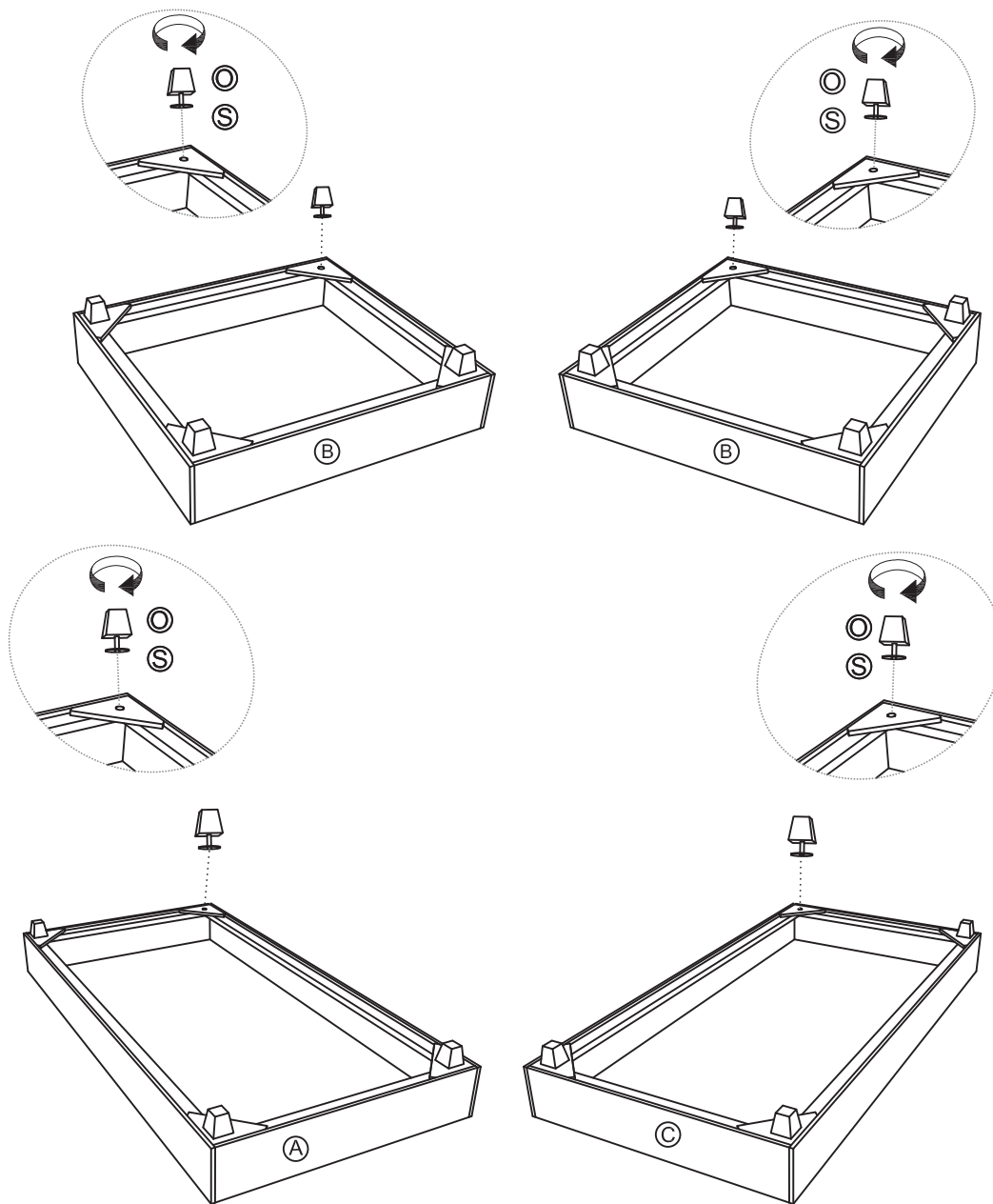
step 1:



⊙		×16
⊙		×16

Assembly Instruction of Sofa

step 2:

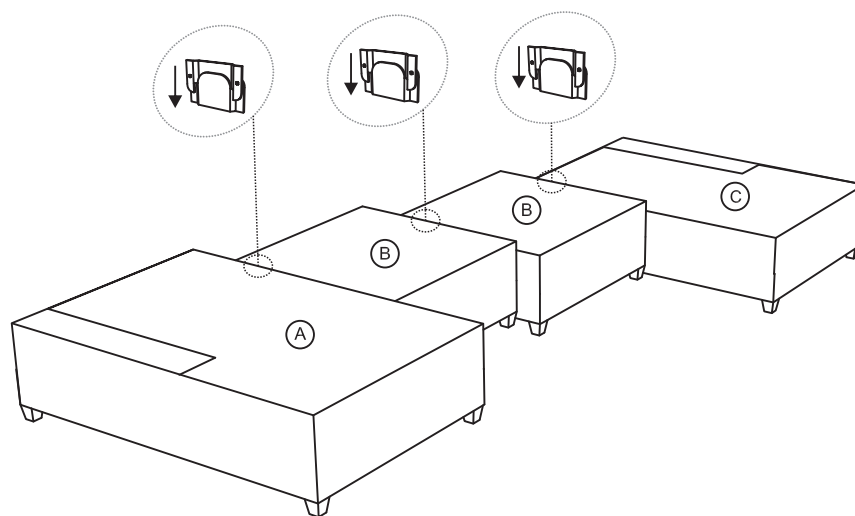

Assemble parts A, B, and C in order. It might help you assemble more easily.

step 3:

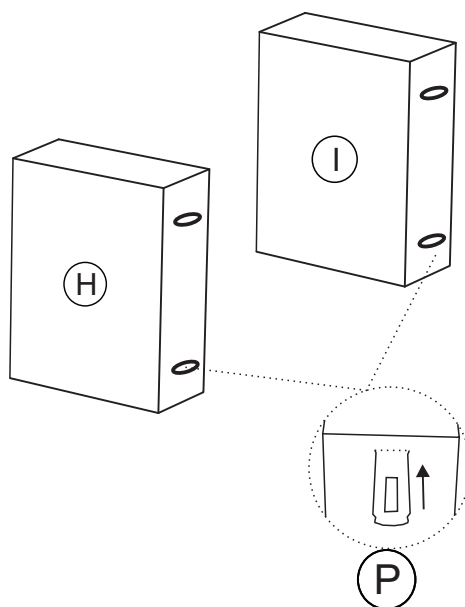

Flip the armrest(as shown on the graph), and insert part P to these armrests.

Assembly Instruction of Sofa

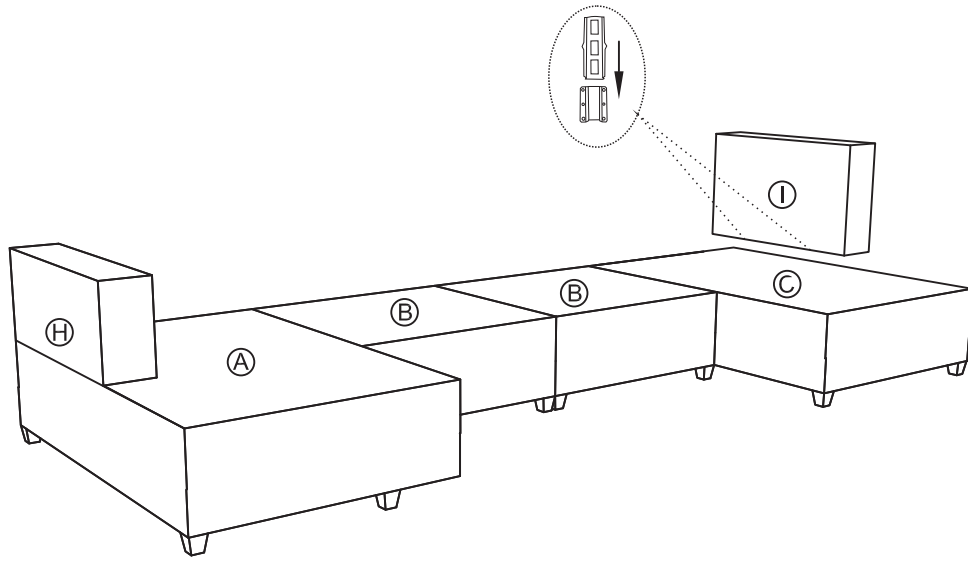

step 4:

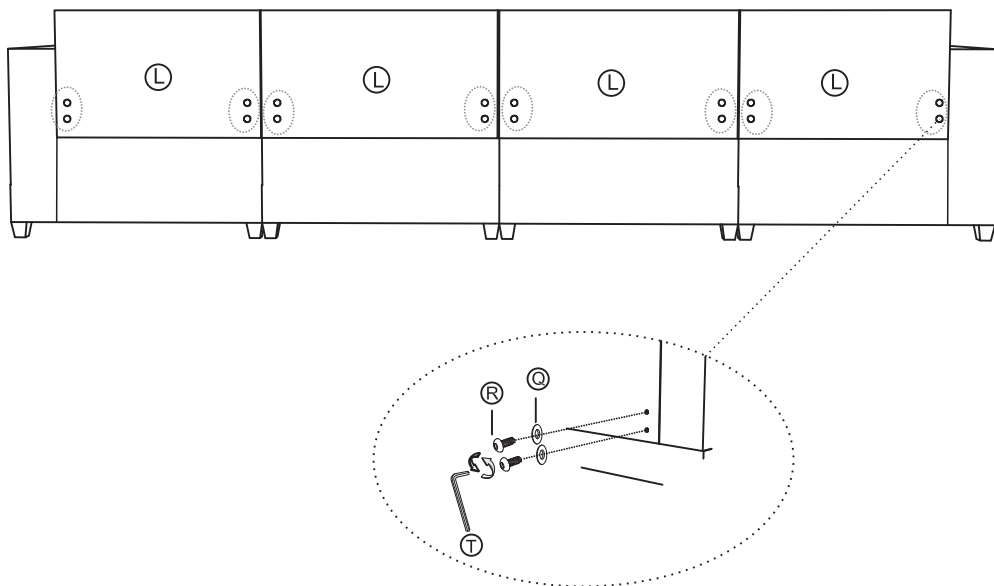

step 5:



Turn the sofa around to assemble the back side of the sofa, using part Q and part R.

Q		×16
R		×16

Assembly Instruction of Sofa

step 6:

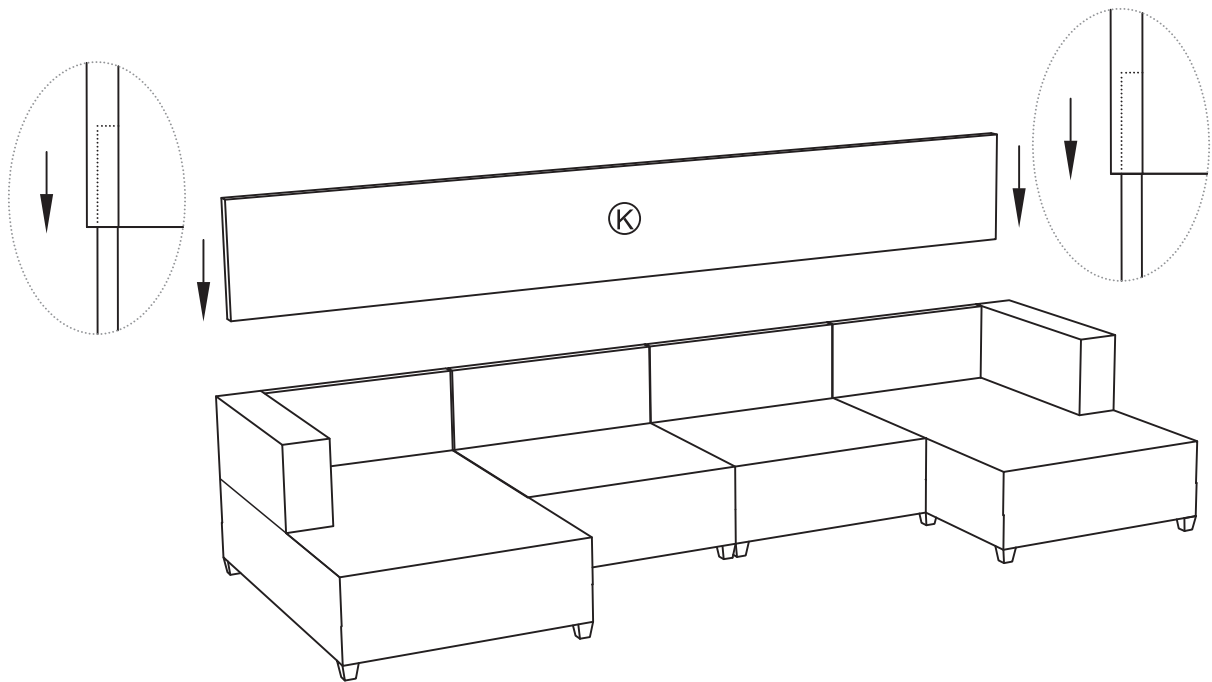

Use K (back cover) to cover backrest

Assembly Instruction of Sofa

step 7:

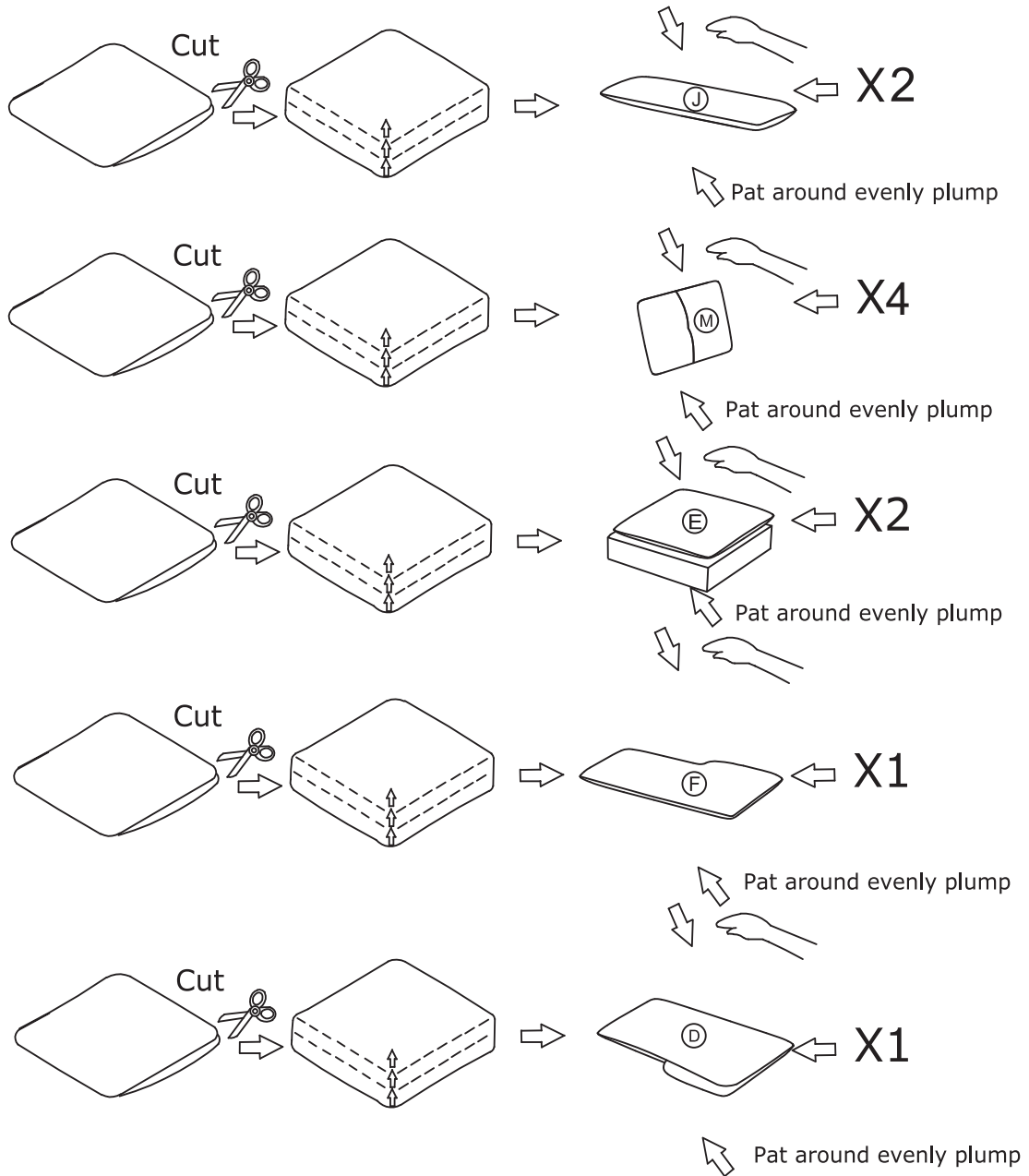

Assembly Instruction of Sofa

step 8:

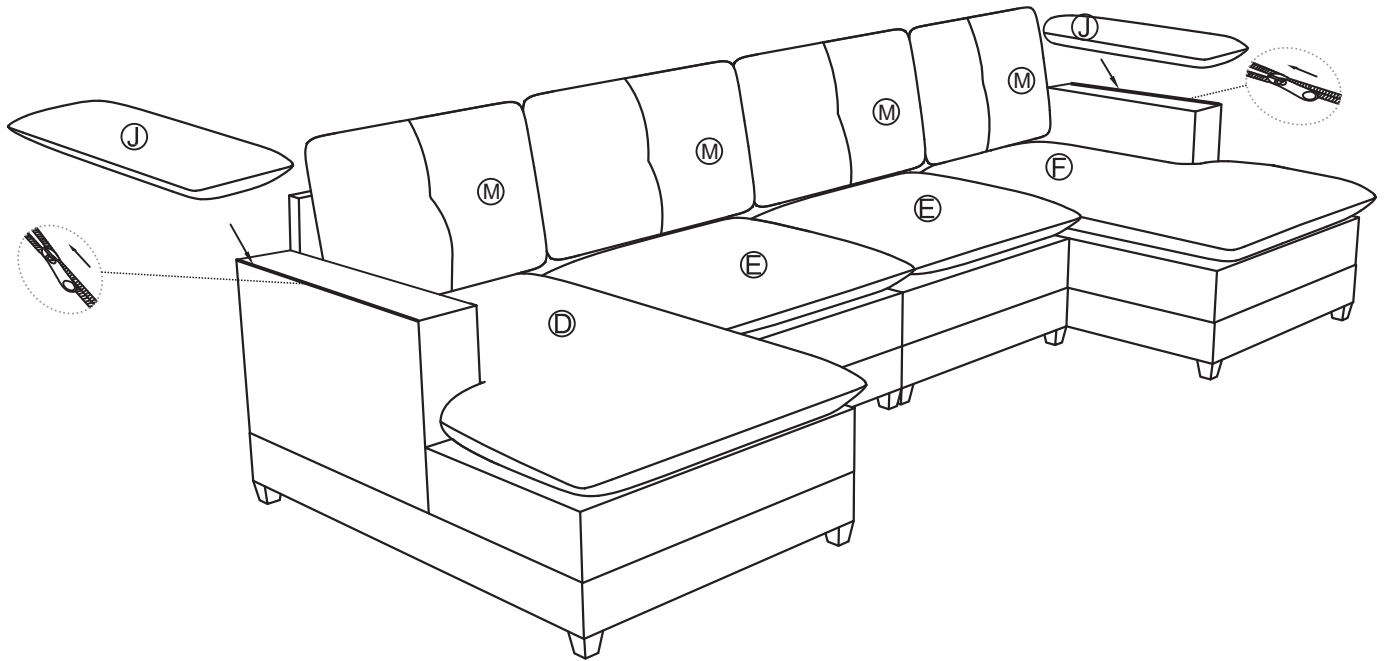

Assembly Instruction of Sofa

