

Assembly Instruction

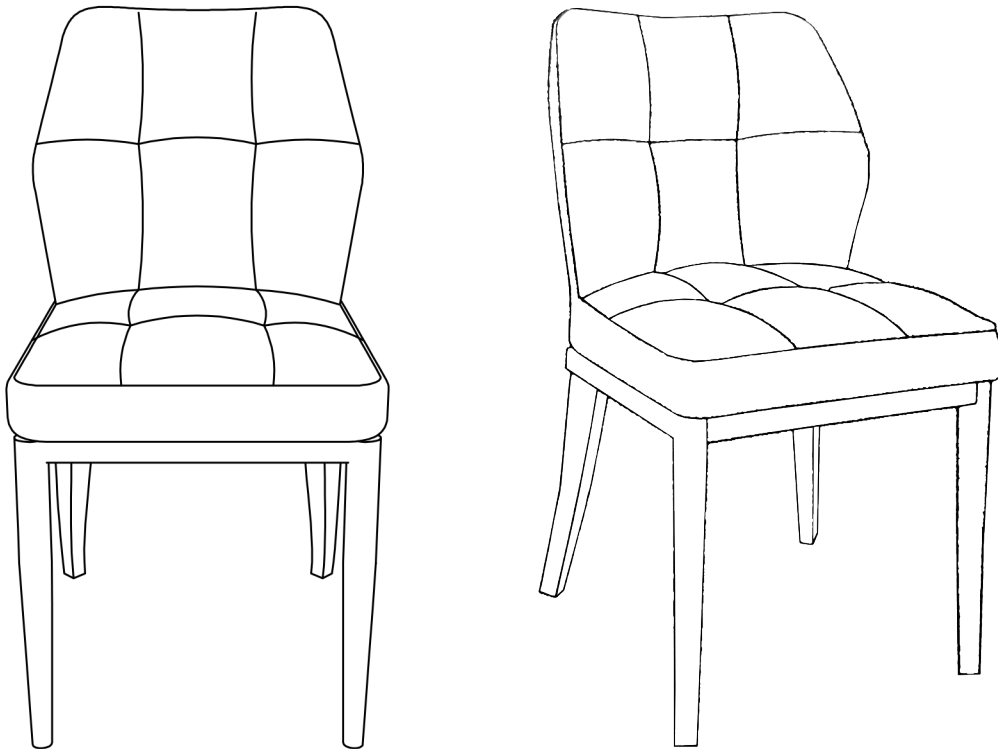

Dining Chairs





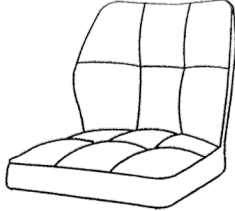

ASSEMBLY TIPS:

1. Remove hardware from box and sort by size.
2. Please check to see that all hardware and parts are present prior to start of assembly.
3. Please follow attached instructions in the same sequence as numbered to assure fast & easy assembly.

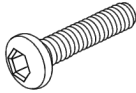
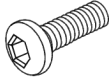
Parts List

Number	Name	Part	Qty
1	Seat		x1PC
2	Leg		x1PC

Number	Hardware	Part	Qty
A	M6*25mm		x1+1EXT
B	M6*20mm		x2+1EXT
C	Washer		x3+1EXT
E	Allen Wrench		x1PC
F	Front Foot		x1PC
G	Back Foot		x1PC

1

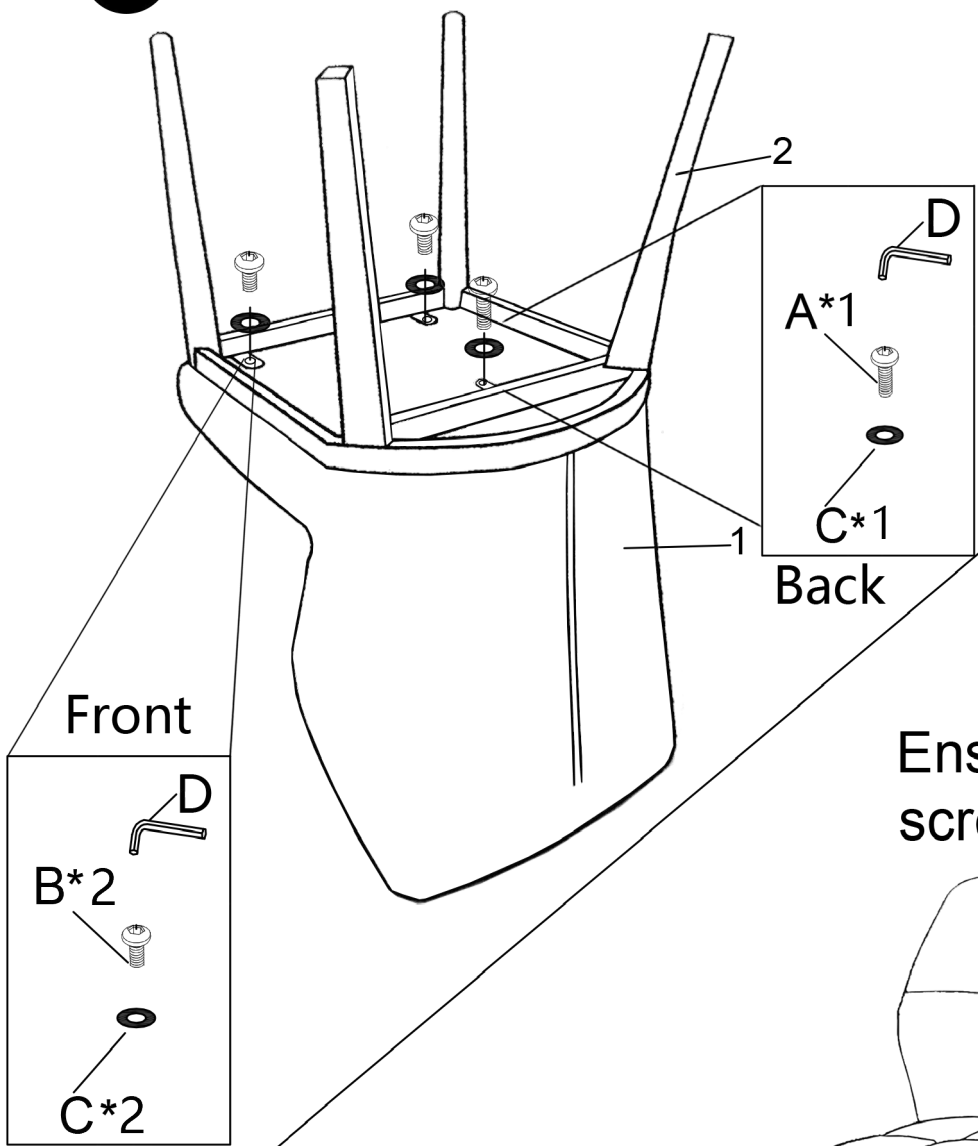
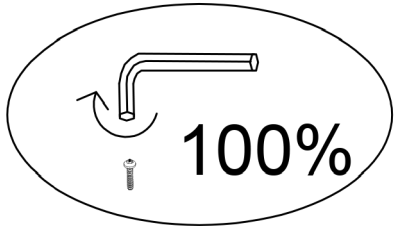

Ensure that each screw is tightened.

2

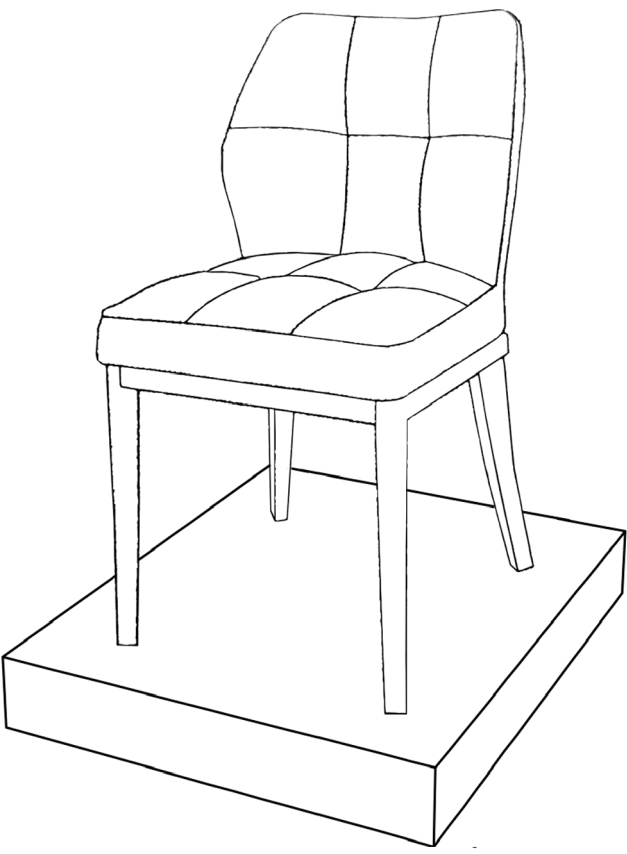

Additional Note About Safety: Bolts may loosen during normal everyday use. They should be periodically inspected and tightened to prevent damage or injury. Always check to be sure that all hardware is kept tightened. Thank you for your purchase.