

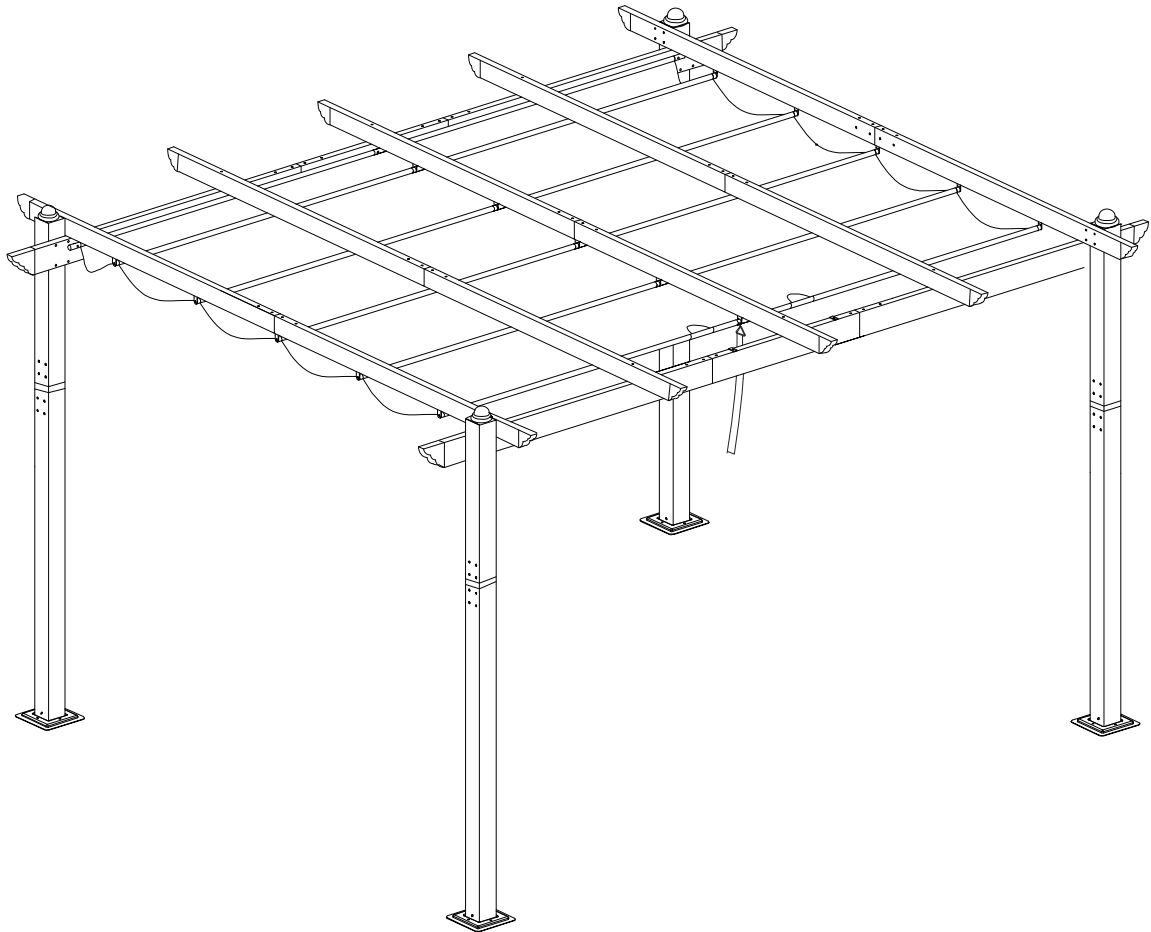

Enjoy Cozy Life!

# MORGAN ALUMINUM 10'X13' PERGOLA ASSEMBLY MANUAL



**KOZYARD LLC PRODUCTS**  
[www.kozyard.com](http://www.kozyard.com)

© Copyright 2016 - 2019 Kozyard LLC. | All Rights Reserved.

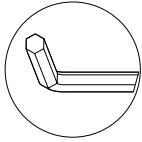

Use the hex keys in the box.



You may need to use a drill for this step.



Three or more people are required at this stage.



You may need a ladder.

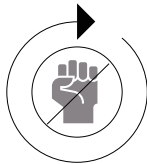







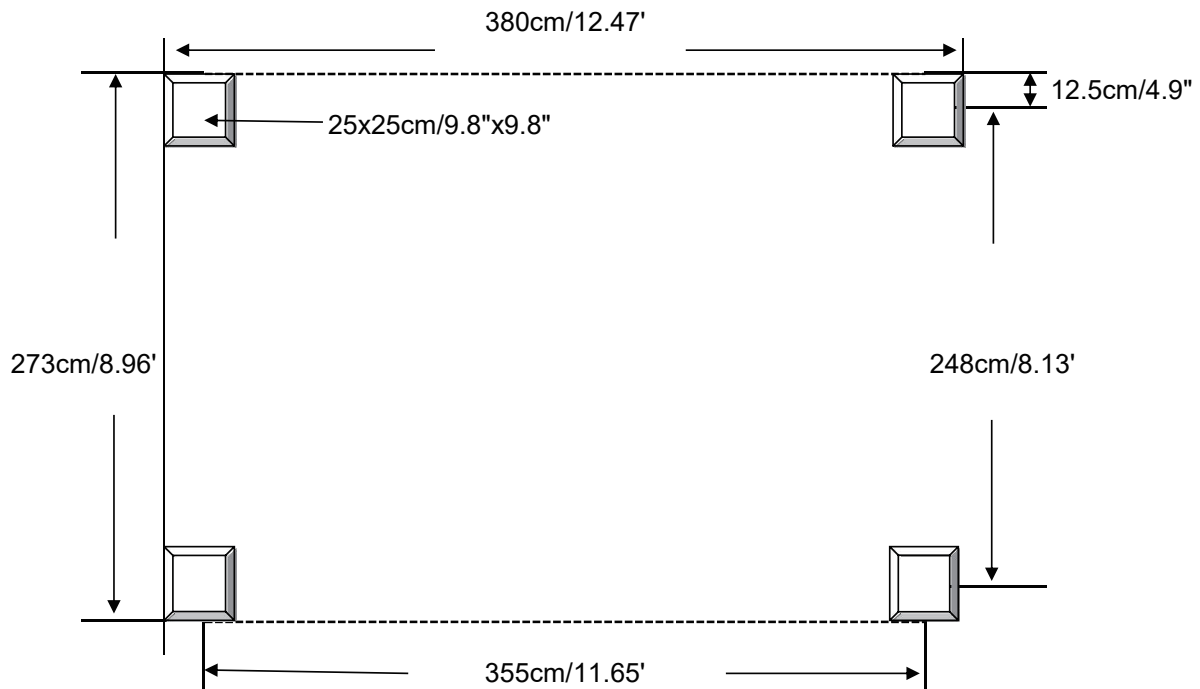



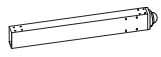
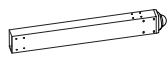
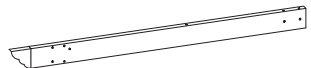

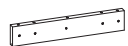

Do not tighten screws all the way for now.

---







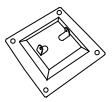
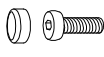

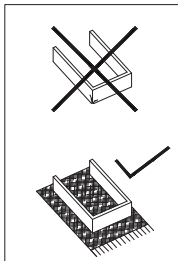

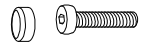

## Pergola 10x13' ANCHOR BLUEPRINT

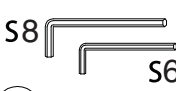

Parts list



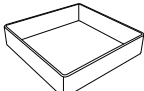

 <p><b>A</b> 4X</p>	 <p><b>A1</b> 2X</p>	 <p><b>A2</b> 2X</p>
 <p><b>B</b> 1X</p>	 <p><b>B1</b> 1X</p>	
 <p><b>B2</b> 1X</p>	 <p><b>C</b> 1X</p>	
 <p><b>C1</b> 1X</p>	 <p><b>C2</b> 1X</p>	
 <p><b>D</b> 2X</p>	 <p><b>D1</b> 2X</p>	
 <p><b>E</b> 1X</p>	 <p><b>E1</b> 1X</p>	
 <p><b>F</b> 2X</p>	 <p><b>F1</b> 2X</p>	
 <p><b>G</b> 1X</p>	 <p><b>G1</b> 1X</p>	
 <p><b>H</b> 5X</p>	 <p><b>H1</b> 5X</p>	
 <p><b>I</b> 4X</p>	 <p><b>J</b> 154X+5X M6x16</p>	

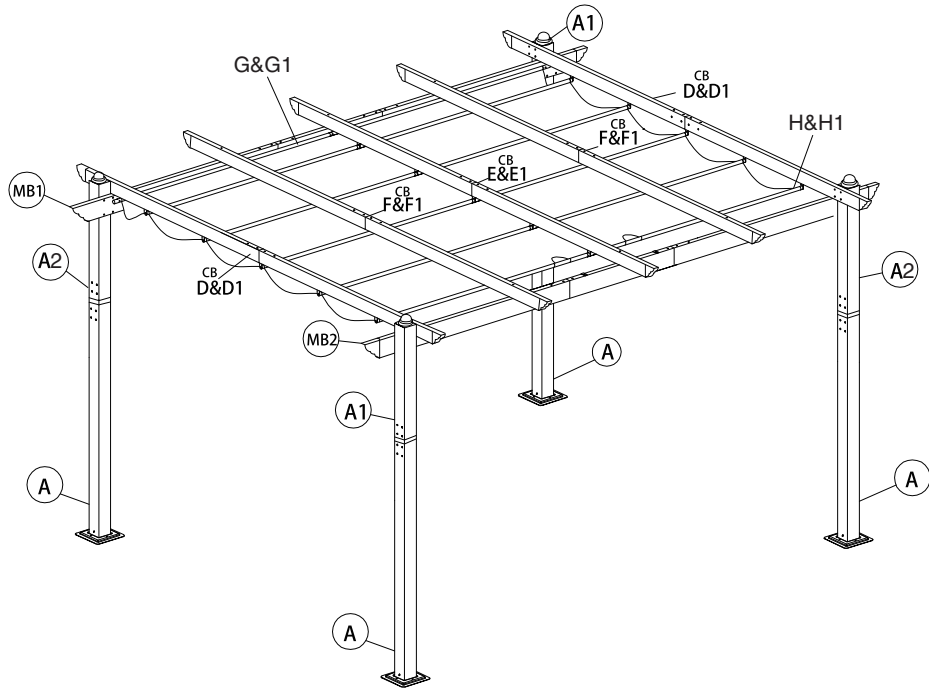

 M6x30 K 3X+1X	 M6x85 L 6X+1X	 M6x15 M 32X+2X	 N 10X
 O 4X	 P 1X	 R 2X	 S 1X
 S8 S6 Q 1X	 T 1X	 U 16x+2x	 V 8x
 V1 4x	 V2 5x	 X 4x	

# OVERALL

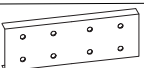
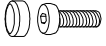
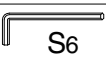

-  (A) 4X
-  (A1) 2X
-  (A2) 2X
-  (X) 4X
-  (V) 8X
-  (J) 64X  
M6x16
-  (Q) 1X  
S6

### Step 1

First Put part X on four poles part A1.  
Then Connect A and A1 by using bolt J to build the four poles.

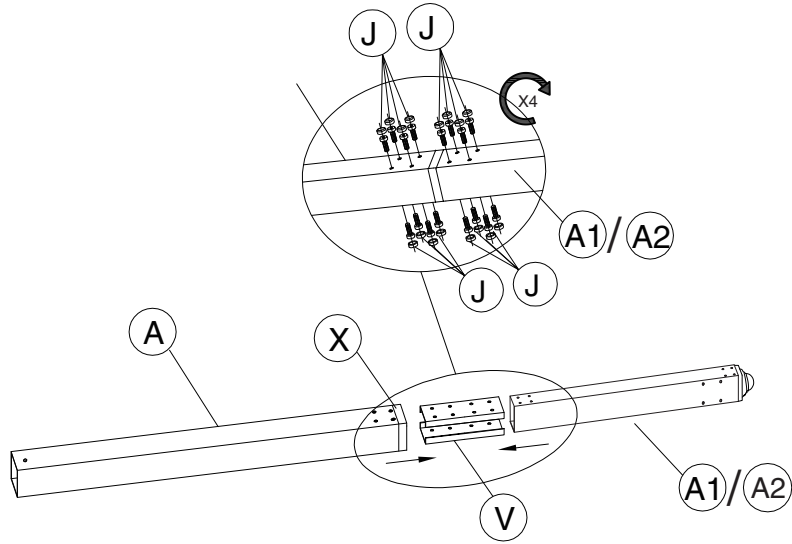



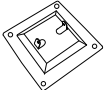
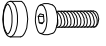
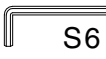



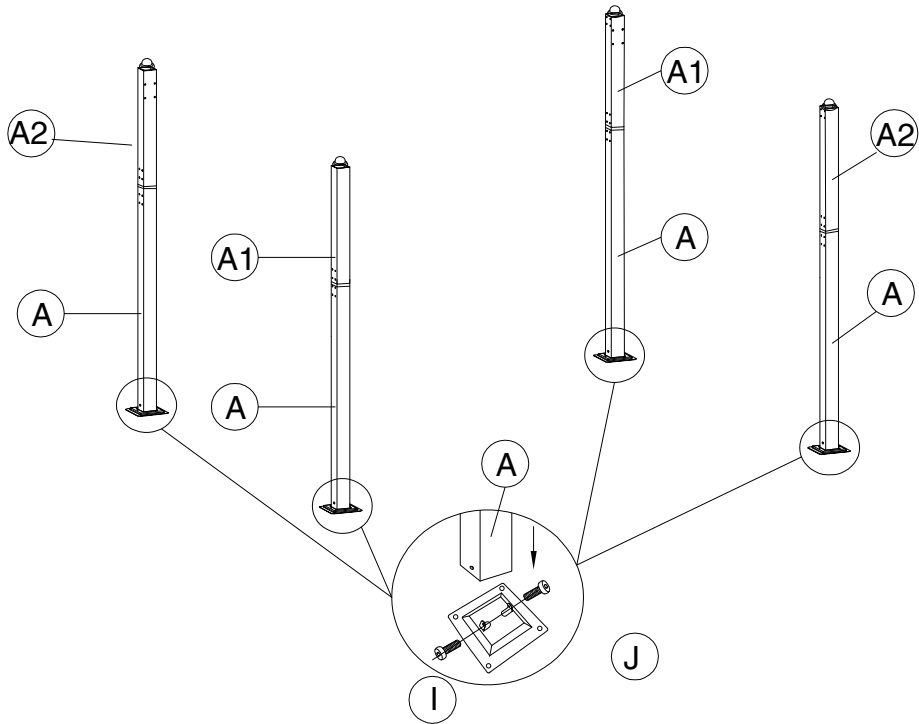

Don't tight the bolts too much when you insert A into A1&A2.

-  (I) 4X
-  (J) 8X  
M6x16
-  (Q) 1X  
S6

### Step 2

Connect Part I and 4 poles by using bolt J.



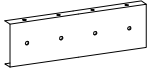
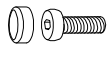
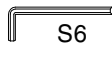

<b>(B)</b> 1X

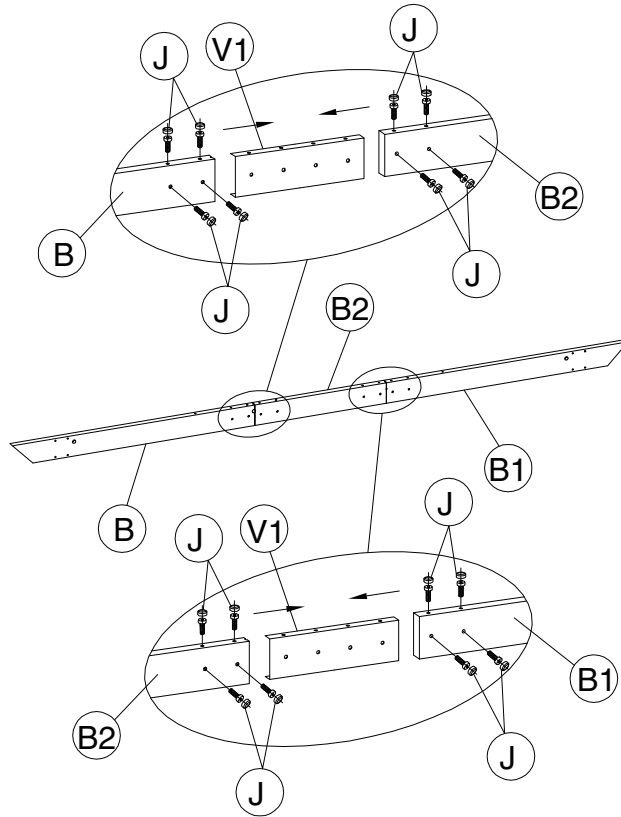
<b>(B1)</b> 1X

<b>(B2)</b> 1X

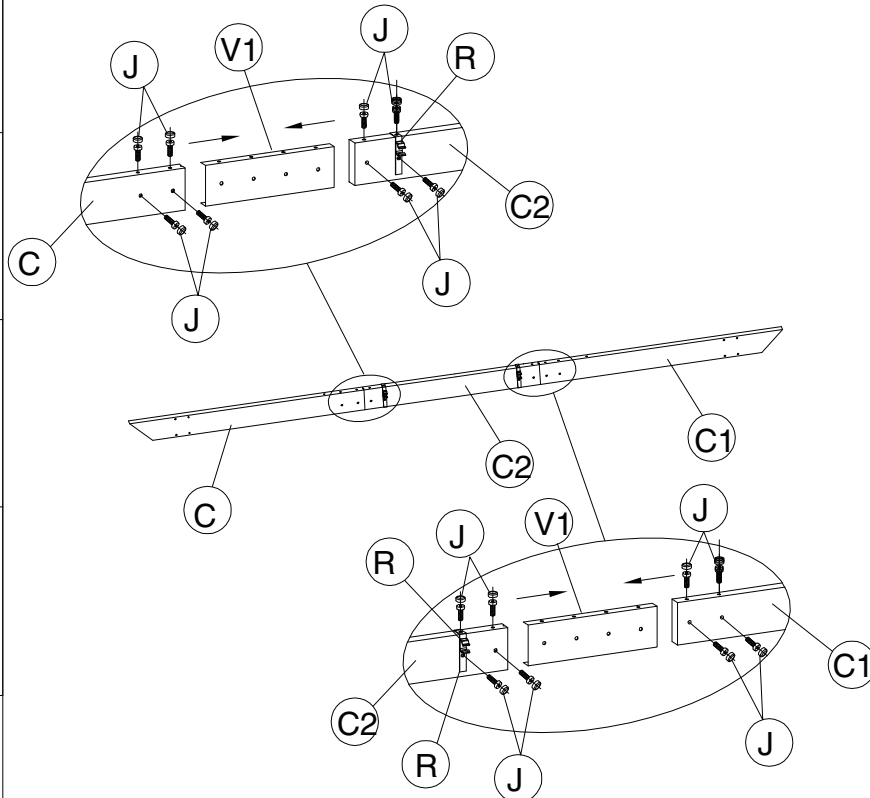
<b>(C)</b> 1X

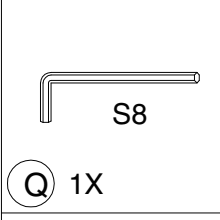
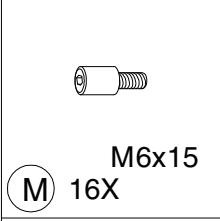
<b>(C1)</b> 1X

<b>(C2)</b> 1X

<b>(R)</b> 2X

<b>(V1)</b> 4x
 M6x16
<b>(J)</b> 32X
 S6
<b>(Q)</b> 1X

**Step 3** Connect B , B1 and B2 by using bolt J to build the main beam 1 .



Connect C, C1 and C2 by using bolt J to build another main beam 2. meanwhile Attach Part R to C2 using bolt J.





**Step 4** Connect the main beam 1 and main beam 2 with the four poles using bolt M.

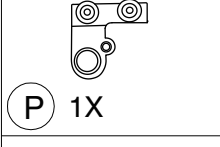
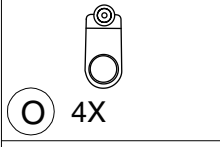
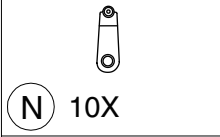
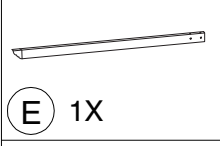
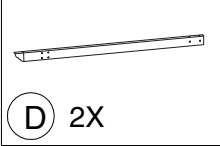
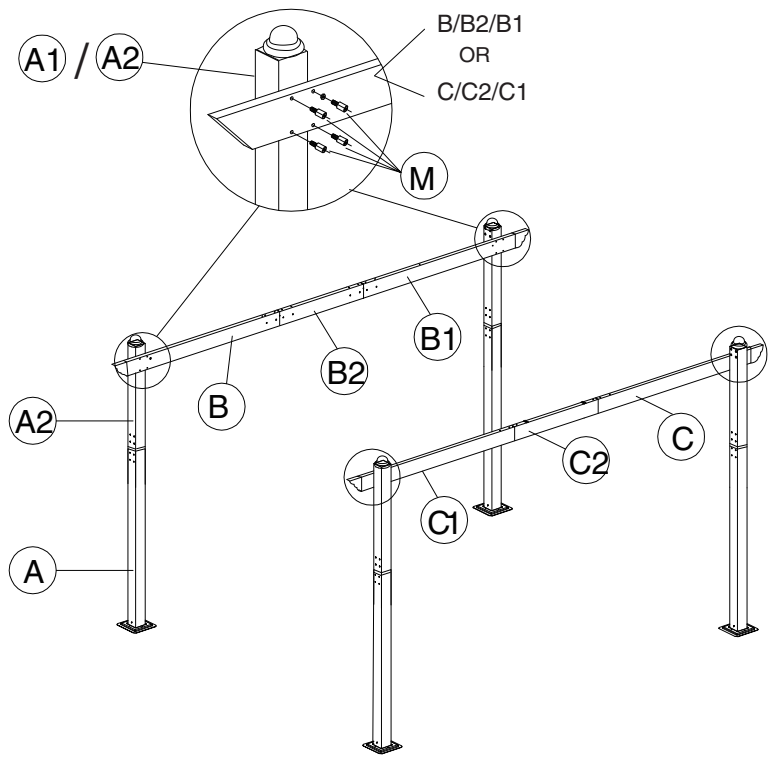

**Step 5**

1. Insert the hook N into the slot of part D, Repeat twice.

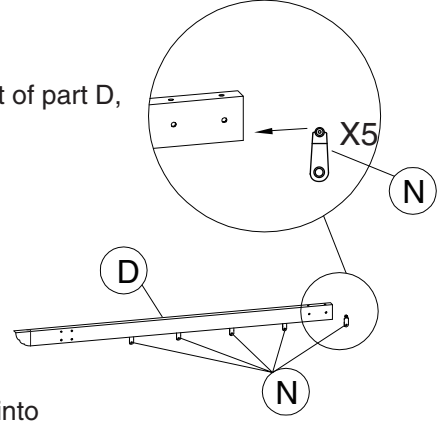

2. Insert the hook P and hook O into the slot of part E. Please insert the hook P by this way. Don't insert the hook P opposite way as diagram!

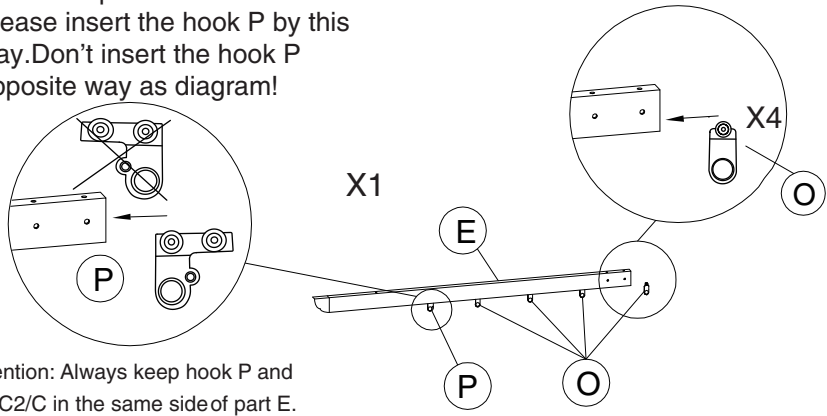

Attention: Always keep hook P and C1/C2/C in the same side of part E.



D 2X



D1 2X



V2 2x

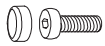

M6x16

J 16X

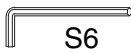

S6

Q 1X

### Step 6

Connect D and D1 to build the cross beam (D&D1) by using bolt J

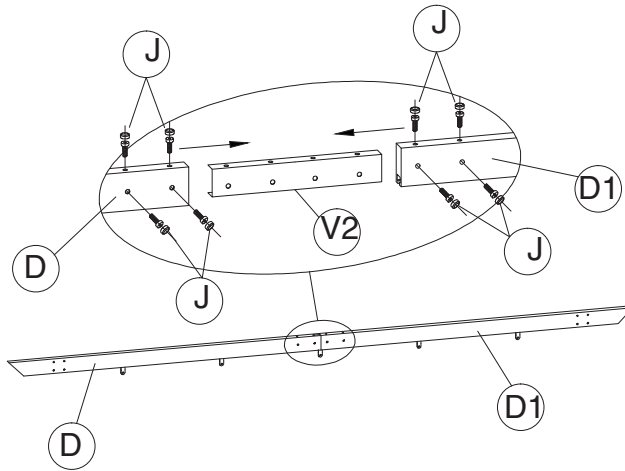

M6x15

M 16X

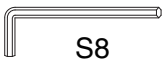





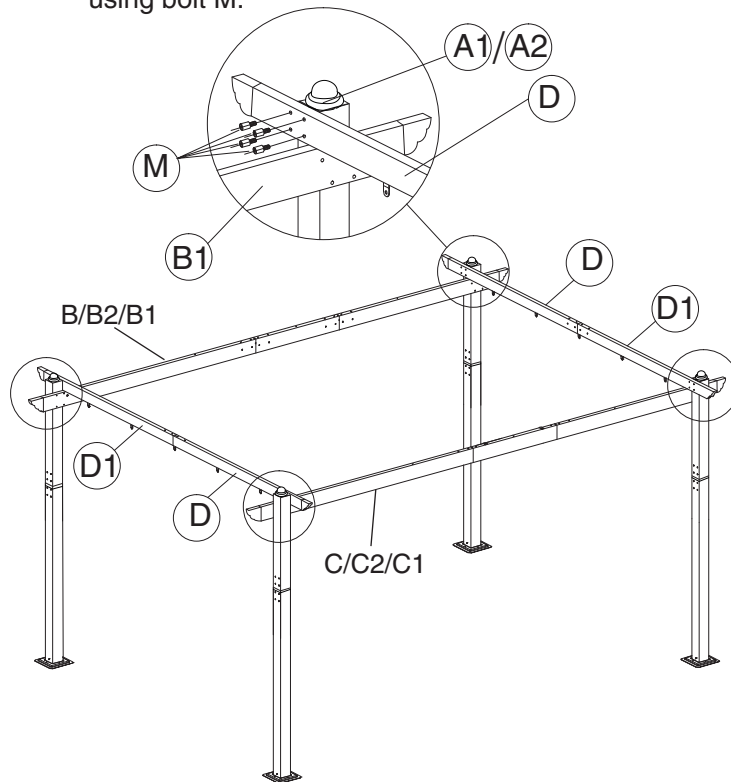

S8

Q 1X

### Step 7

Connect the cross beam (D&D1) with the four poles using bolt M.

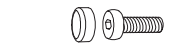
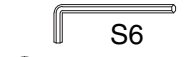

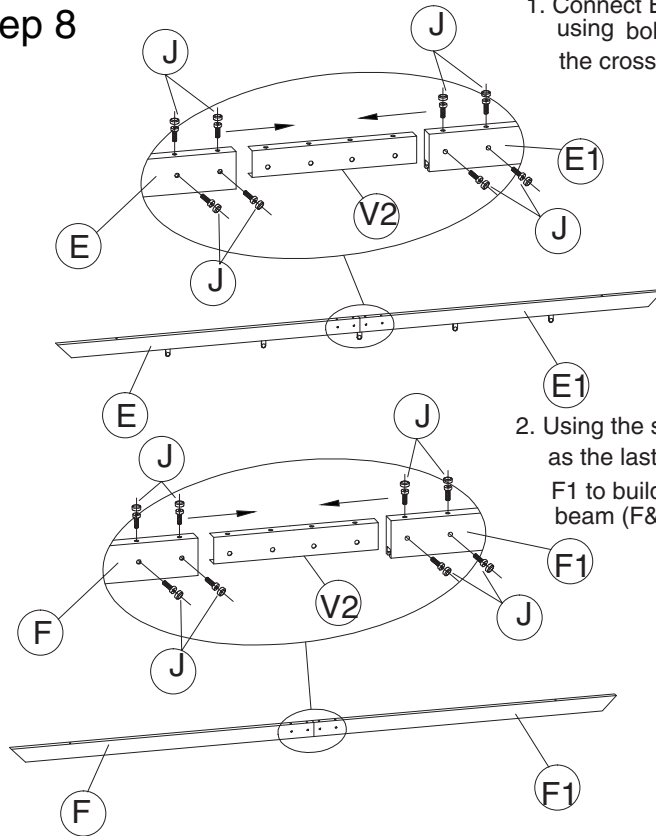

<b>(E)</b> 1X

<b>(E1)</b> 1X

<b>(F)</b> 2X

<b>(F1)</b> 2X

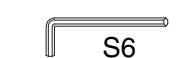
<b>(J)</b> 12X M6x16

<b>(Q)</b> 1X S6

<b>(V2)</b> 5x

### Step 8



1. Connect E and E1 by using bolt J to build the cross beam (E&E1).





2. Using the same method as the last step, use F and F1 to build the cross beam (F&F1).

<b>(L)</b> 6X M6x85

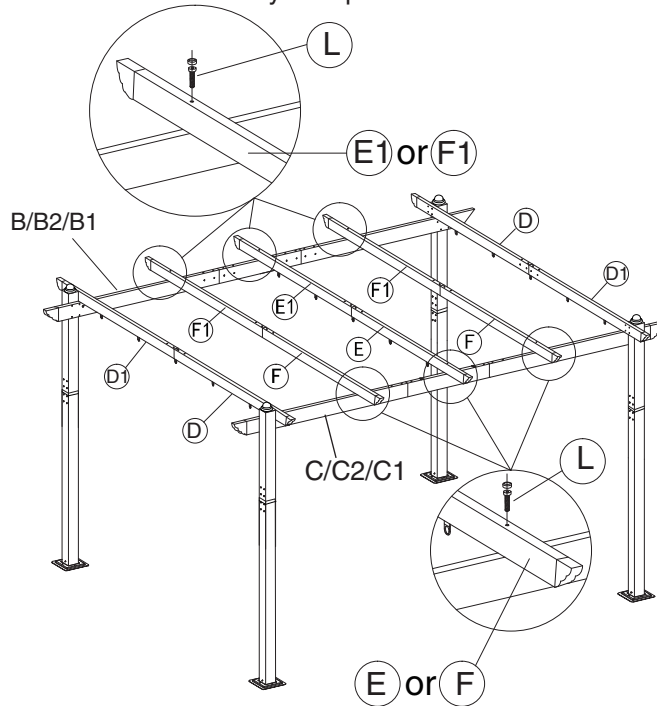
<b>(Q)</b> 1X S6

### Step 9

Connect the cross beam (E&E1) and (F&F1) with the main beam 1 and 2.  
Attention: Always keep hook P and C/C2/C1 in the same side.





-  **G** 1X
-  **G1** 1X
-  **H** 5X
-  **H1** 5X
-  **S** 1X

**Step 10**

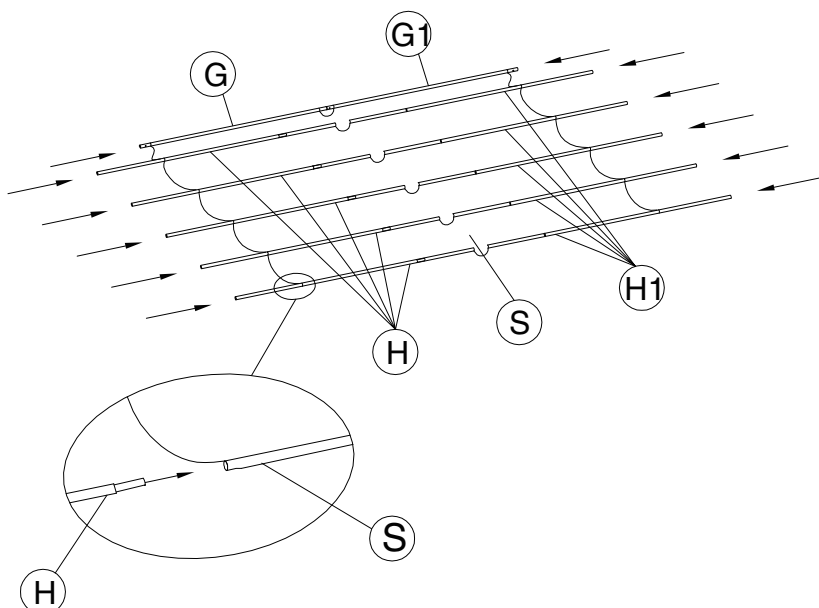
Insert G, G1, H, H1 into the canopy from its side

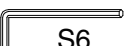

-  **J** 10X M6x16
-  **K** 3X M6x30
-  **Q** 1X S6

**Step 11**

Connect G&G1 and B&B2&B1 by bolt K, and hold the canopy with the frames.

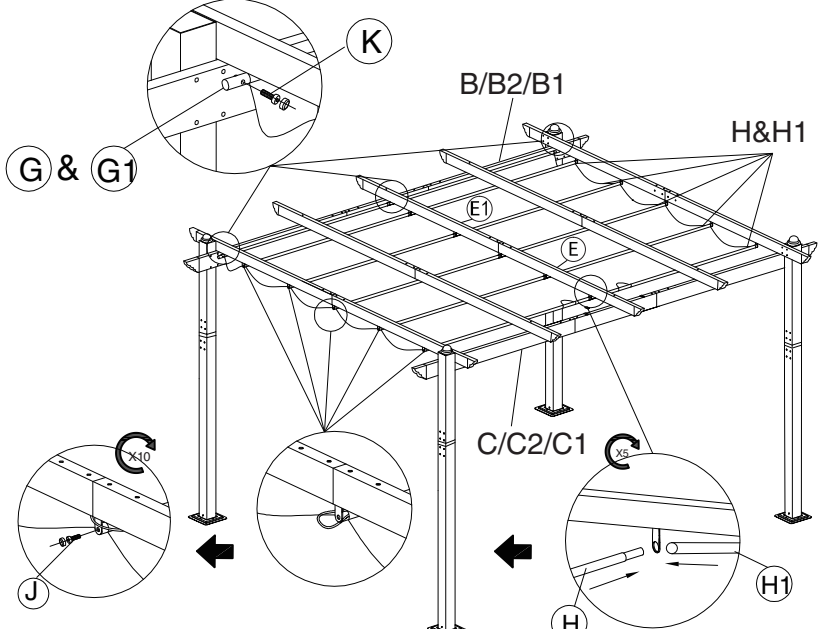

Connect the canopy and the hook using bolt J

Pull the line from the canopy and put on hook to tighten the canopy.

Connect H and H1 through the hook to tighten the canopy.

## Step 12

**T** 1X

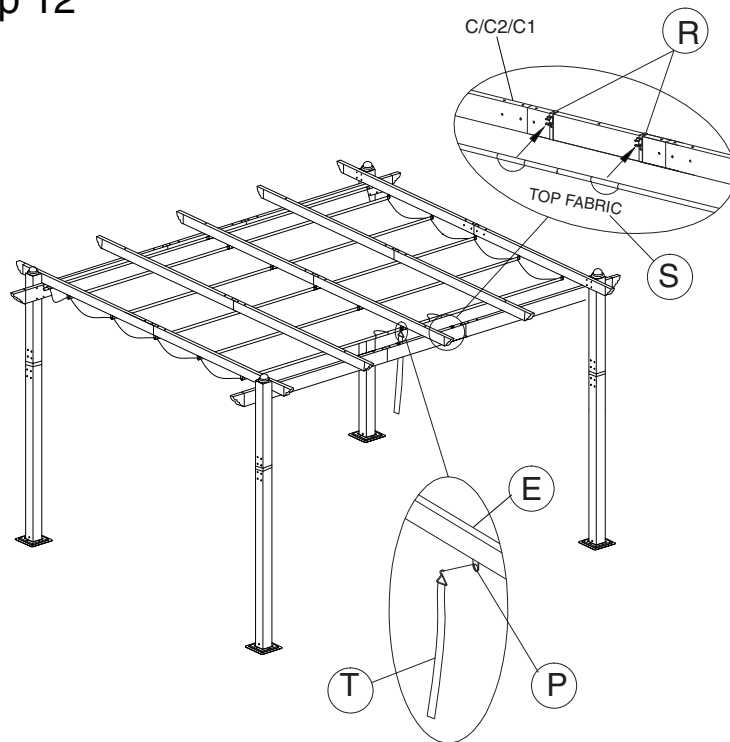

Hook part T onto hook P

## Step 13

**U** 16X

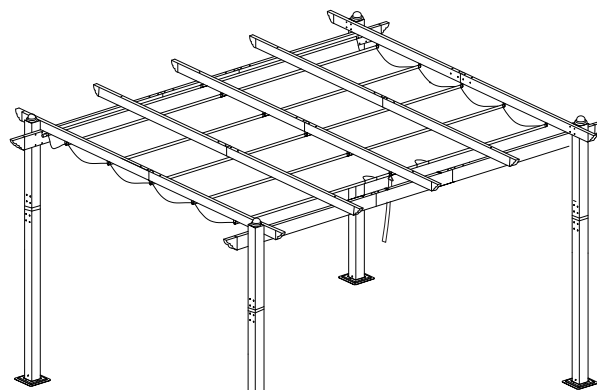

Secure the foot I to the ground using part U.



Enjoy Cozy Life!

**SUPPORT:**

Toll free: 1-800-355-0018

[www.kozyard.com](http://www.kozyard.com)

email: [support@kozyard.com](mailto:support@kozyard.com)

**SOCIAL MEDIA:**



Follow us on Instagram

[www.instagram.com/kozyard](http://www.instagram.com/kozyard)

Upload a picture of your Kozyard product in your home, with the hashtag #kozyard to receive \$20 Kozyard Gift Card.

Kozyard LLC  
2825 80th AVE SE, Suite 202  
Mercer Island, WA 98040