

Instruction Manual

2 DOOR WARDROBE

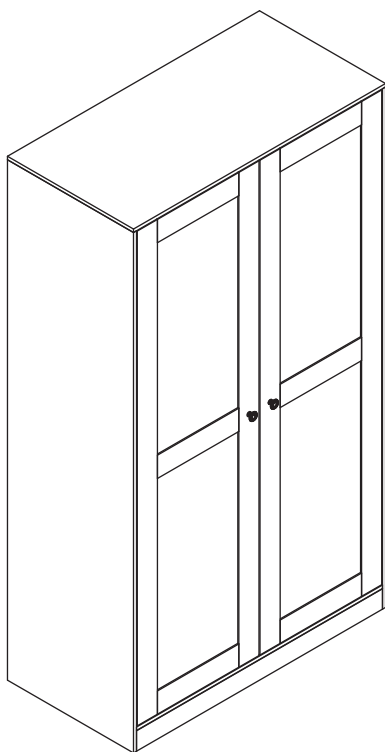

CONTENTS

Safety and care advice	1
Components – panels	2
Components – fittings	3
Assembly instructions	4
Copyright	17
Door alignment	18



SAFETY AND CARE ADVICE



PLEASE READ THESE INSTRUCTIONS CAREFULLY AND KEEP FOR FUTURE REFERENCE

Warning: Please lift with care.

- Check you have all the components and tools listed on pages 2 and 3.
- Remove all fittings from the plastic bags and separate them into their groups.
- Keep children and animals away from the work area, small parts could choke if swallowed.
- Make sure you have enough space to layout the parts before starting.
- Do not stand or put weight on the product, this could cause damage.
- Assemble the item as close to its final position (in the same room) as possible.
- Assemble on a soft level surface to avoid damaging the unit or your floor (use opened out unit carton).



·We do not recommend the use of power drill/drivers **for inserting screws**, as this could damage the unit. Only use hand screwdrivers.

·**Safety note:** If there is any chance of this unit being pulled over by children etc. it is recommended that the unit is secured to a wall using suitable fixings.

·Dispose of all packaging carefully and responsibly.

CARE AND MAINTENANCE

- Only clean using a damp cloth and mild detergent, do not use bleach or abrasive cleaners.
- From time to time check that there are no loose screws on this unit.

·This product should not be discarded with household waste. Take to your local authority waste disposal center.

Note: *If required the next page can be cut out and used as reference throughout the assembly. Keep this page with these instructions for future reference*

COMPONENTS — PANELS

Please check you have all the panels listed below:

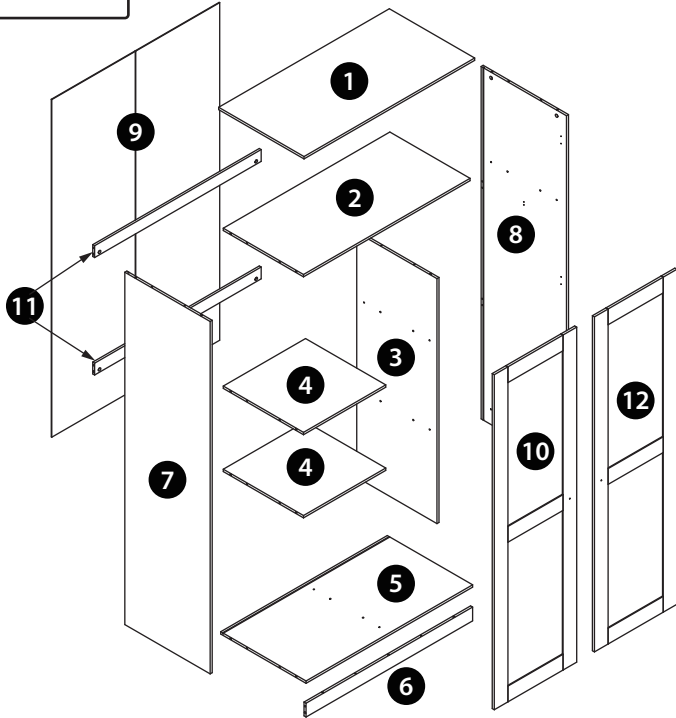















PANEL LIST

PACK 1/3		4 Shelf Panel	x1
1 Top Panel	x1	5 Bottom Panel	x1
2 Shelf Panel	x1	10 Door	x1
4 Shelf Panel	x1	12 Door	x1
6 Skirt Panel	x1	PACK 3/3	
11 Back Bar	x2	7 Left Side Panel	x1
PACK 2/3		8 Right Side Panel	x1
3 Vertical Panel	x1	9 Back Panel	x1



COMPONENTS — FITTINGS

Please check you have all the fittings listed below:

- | | | | |
|----------|---|----------|---|
| A |  | J |  |
| | Metal Dowel x 31 | | Back Support x 6 |
| B |  | K |  |
| | Lock (Ø15x9.5mm) x 31 | | Hinge x 6 |
| C |  | L |  |
| | Screw (Ø4x40mm) x 2 | | Anti-topple Device x 2 |
| D |  | M |  |
| | Wooden Dowel (Ø8x30mm) x 32 | | Screw (Ø3x14mm) x 6 |
| E |  | N |  |
| | Screw (Ø4x20mm) x 2 | | Foot pad (30x15mm) x 6 |
| F |  | | |
| | Handle x 2 | | |
| G |  | | |
| | Screw (Ø4x14mm) x 28 | | |
| H |  | | |
| | Bracket x 2 | | |
| I |  | | |
| | Clothes rail x 1 | | |

TOOLS NEEDED
(We don't provide)







Phillips Screwdriver x 1



ASSEMBLY INSTRUCTIONS

Step 1



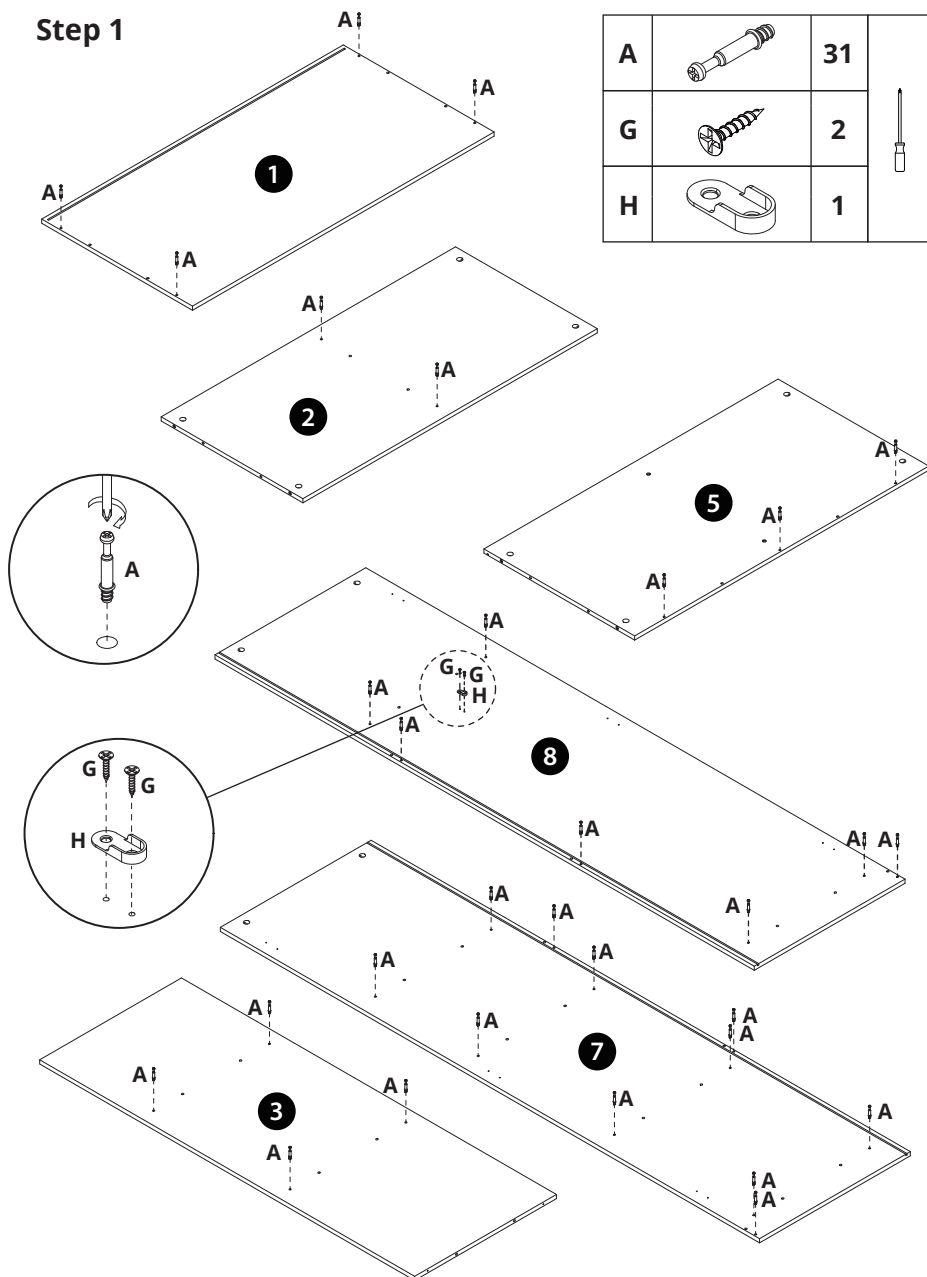

A		31	
G		2	
H		1	

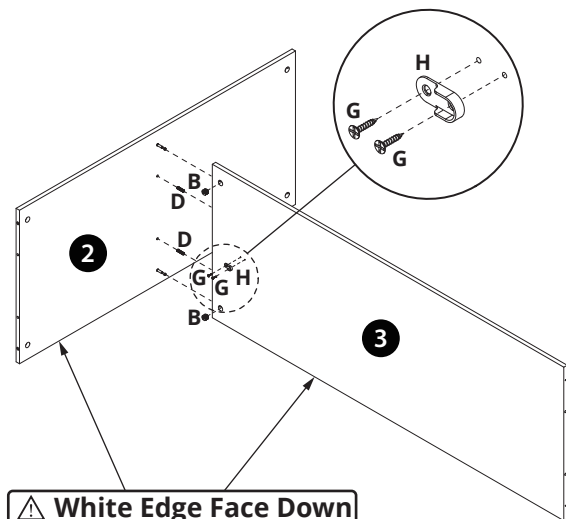

ASSEMBLY INSTRUCTIONS

Step 2





B		2	
D		2	
G		2	
H		1	

 White Edge Face Down

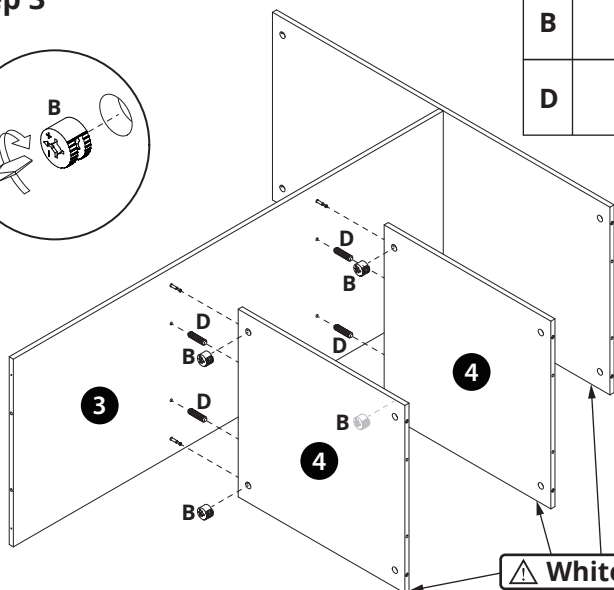
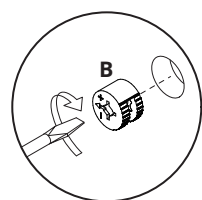
Step 3



B		4	
D		4	

 White Edge Face Down

ASSEMBLY INSTRUCTIONS

Step 4

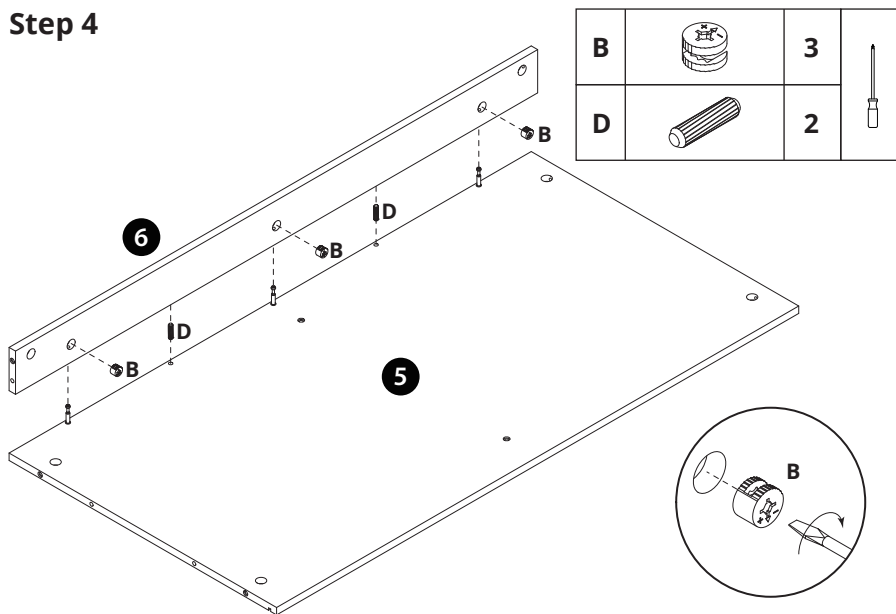

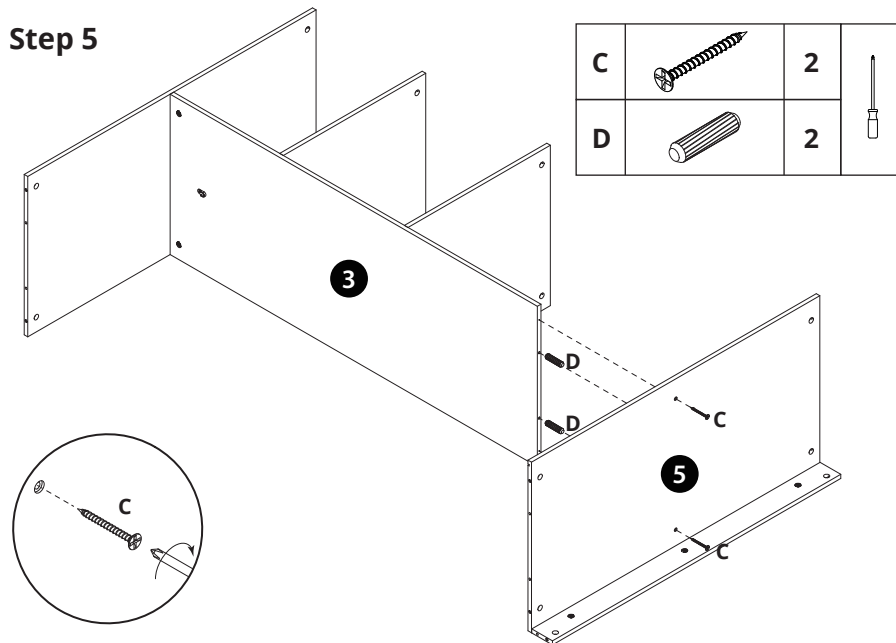

Step 5



ASSEMBLY INSTRUCTIONS

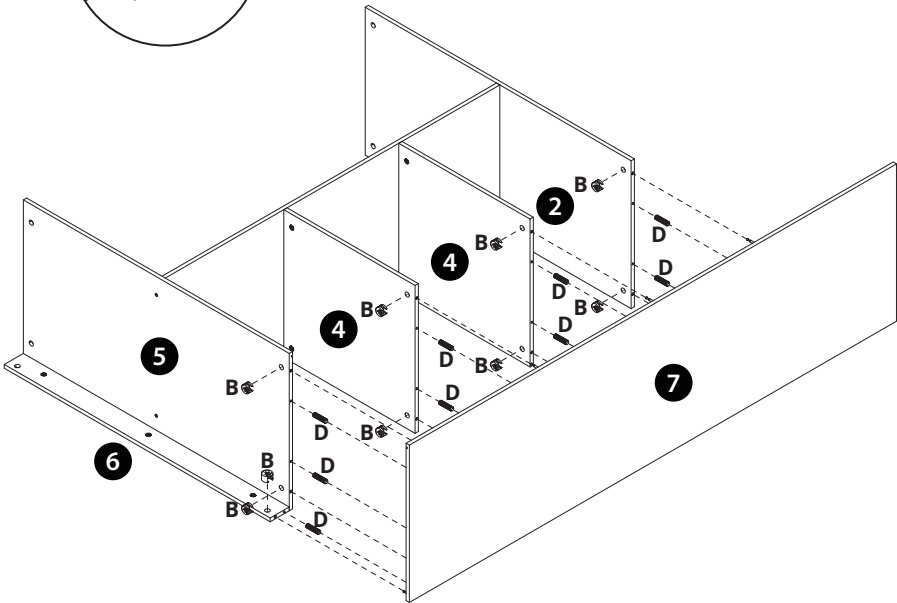
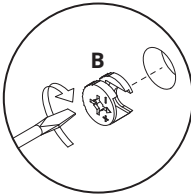

Step 6

B		9	
D		9	



ASSEMBLY INSTRUCTIONS

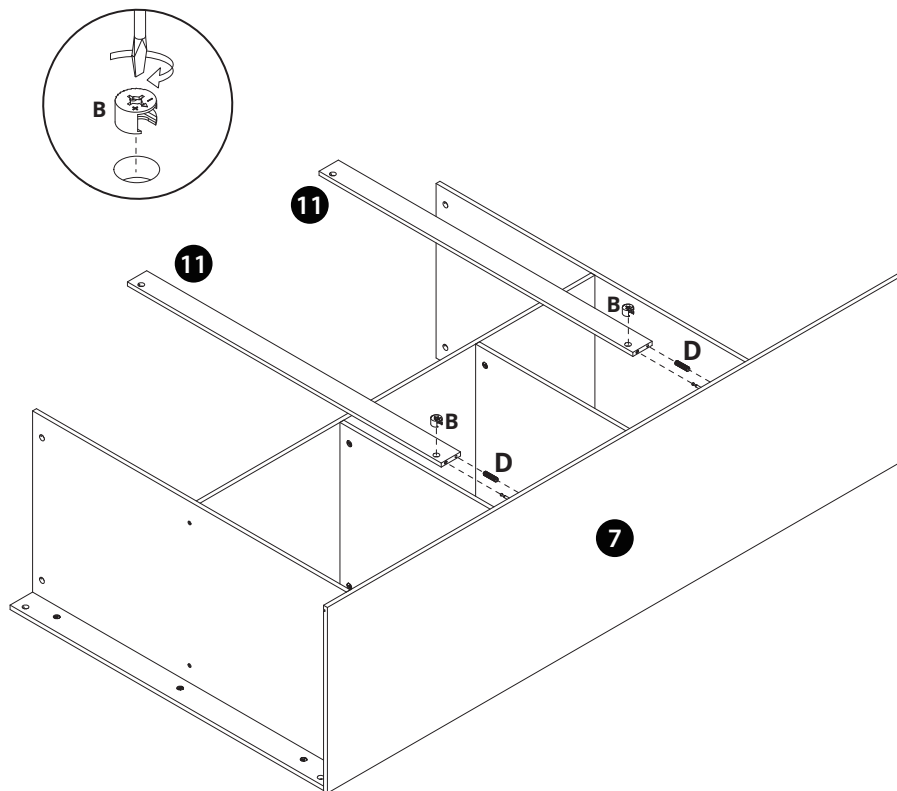

Step 7

B		2	
D		2	



ASSEMBLY INSTRUCTIONS

Step 8

B		7	
D		7	

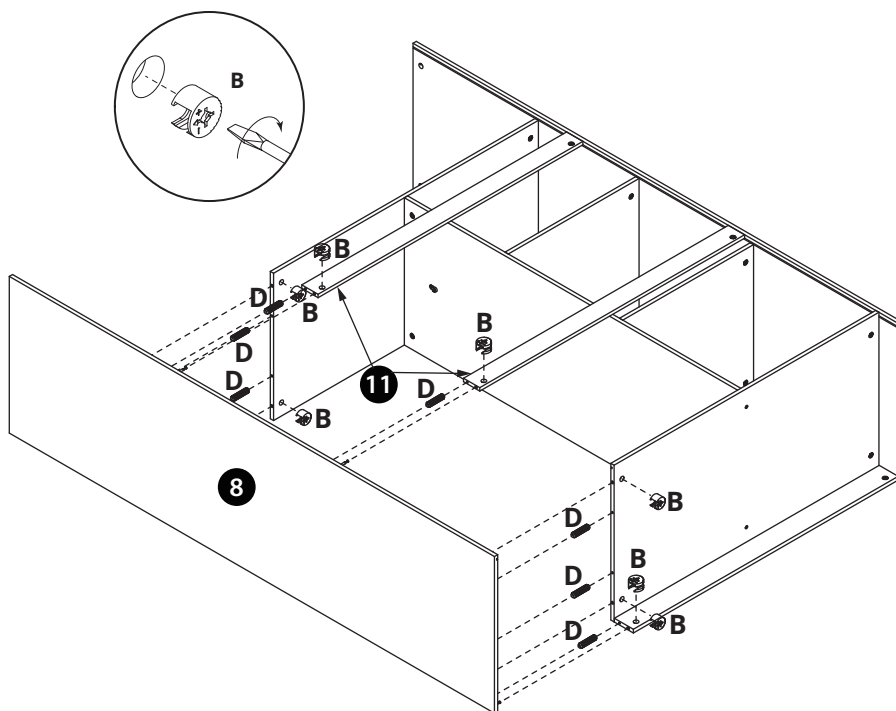

ASSEMBLY INSTRUCTIONS

Step 9

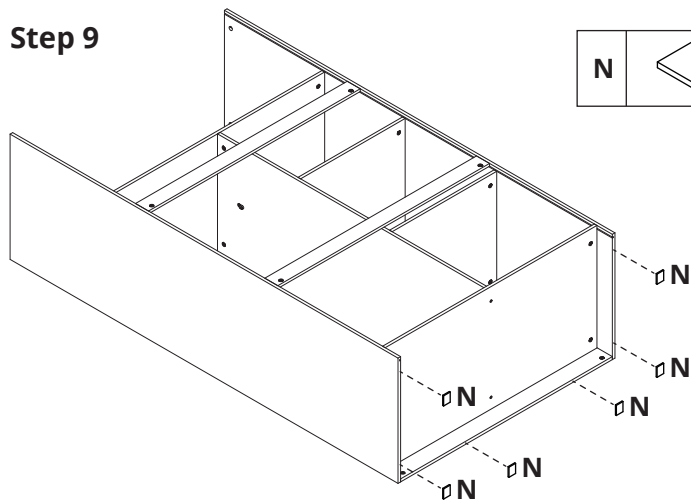

N		6	
---	---	---	--

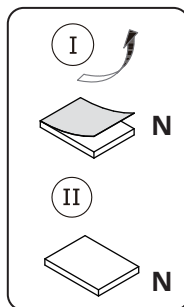



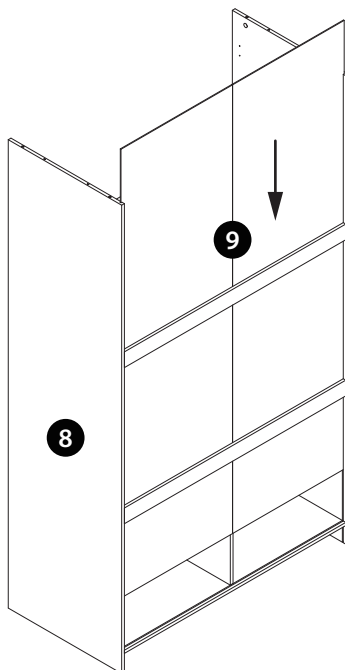

Step 10

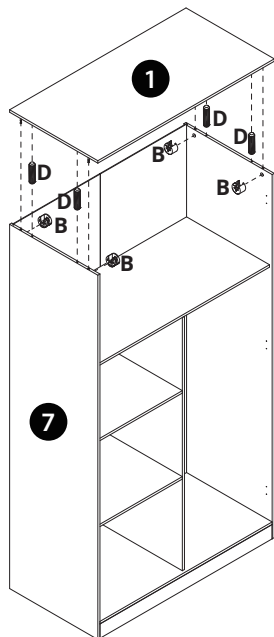

ASSEMBLY INSTRUCTIONS

Step 11



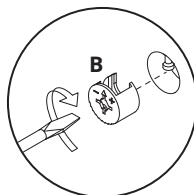

B		4	
D		4	

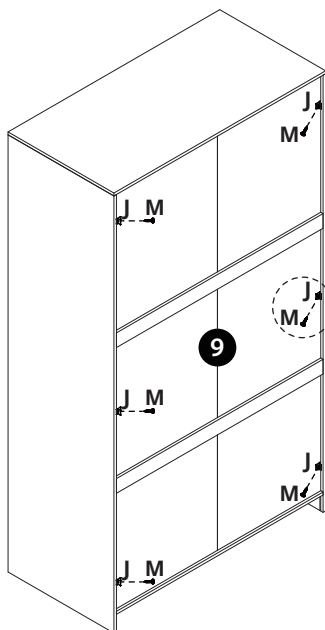

Step 12





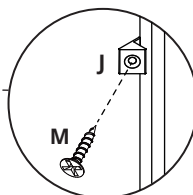

M		6	
J		6	



ASSEMBLY INSTRUCTIONS

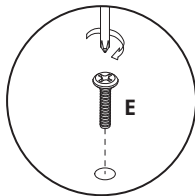
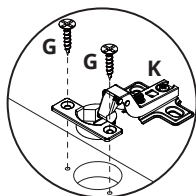
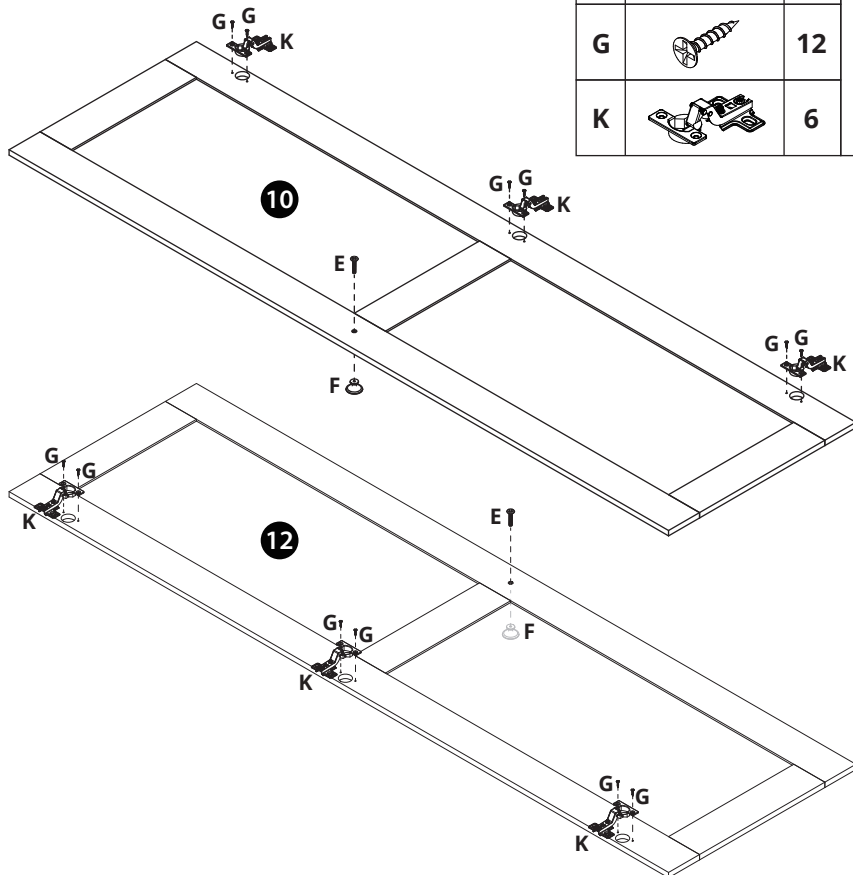

Step 13

E		2	
F		2	
G		12	
K		6	



ASSEMBLY INSTRUCTIONS

Step 14

G		12	
---	---	----	---

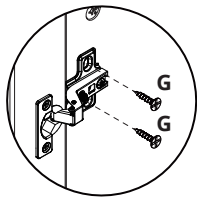
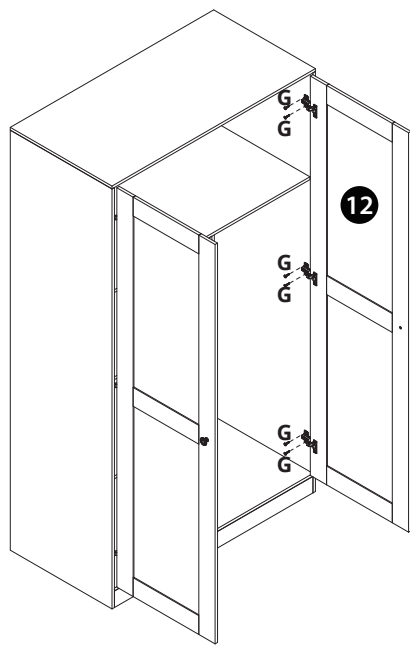
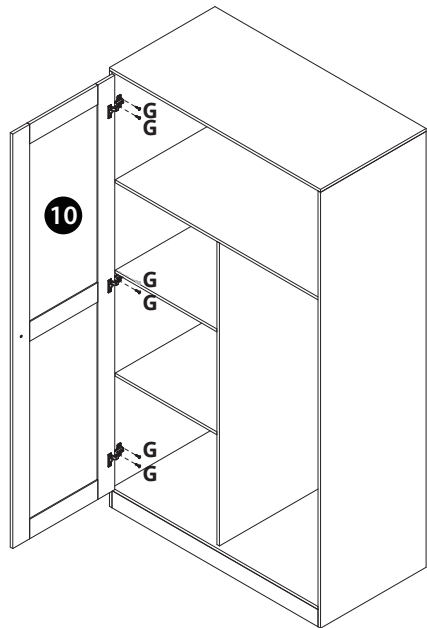
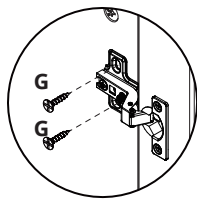

ASSEMBLY INSTRUCTIONS

Step 15

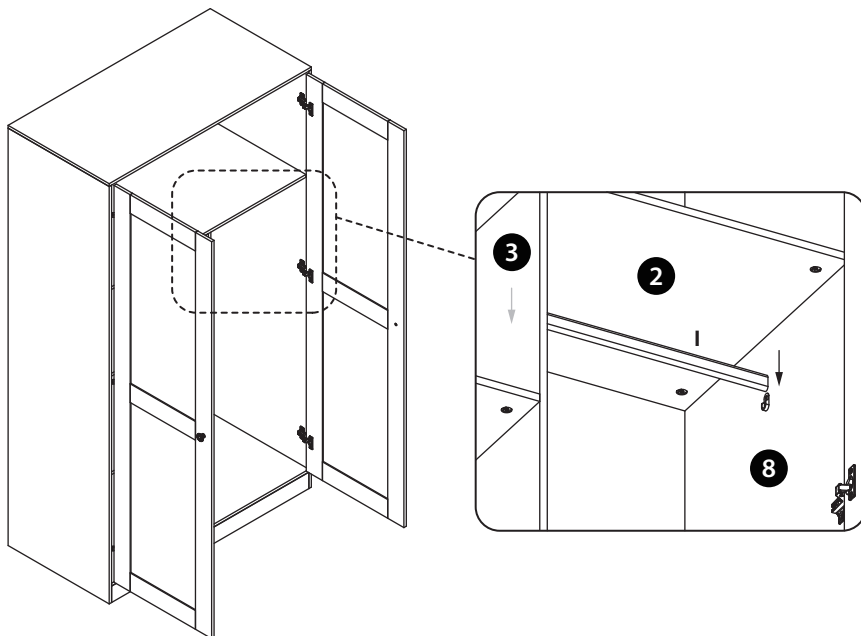
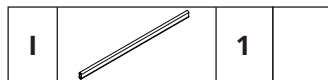

ASSEMBLY INSTRUCTIONS

Step 16

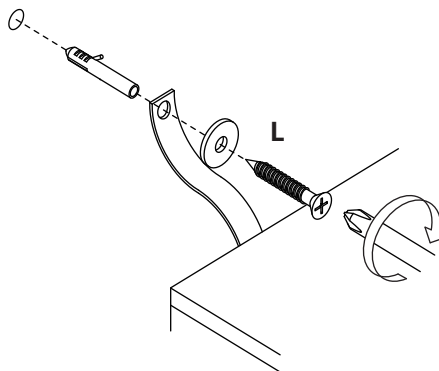
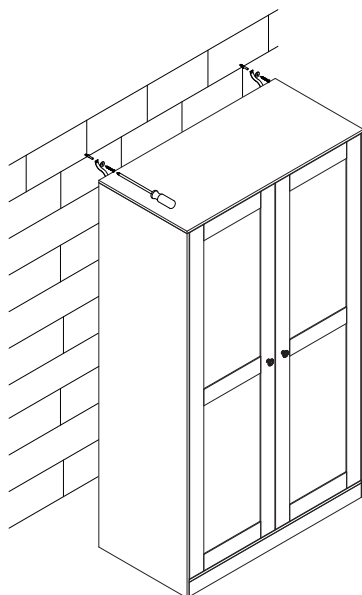
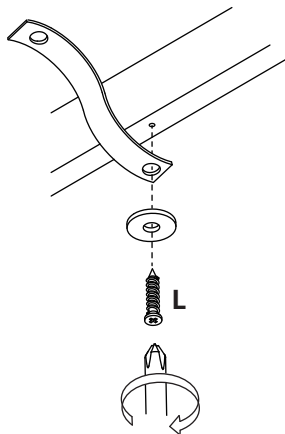
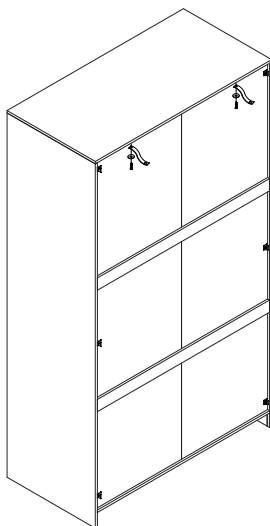
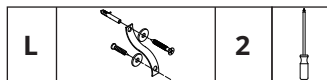

ASSEMBLY INSTRUCTIONS

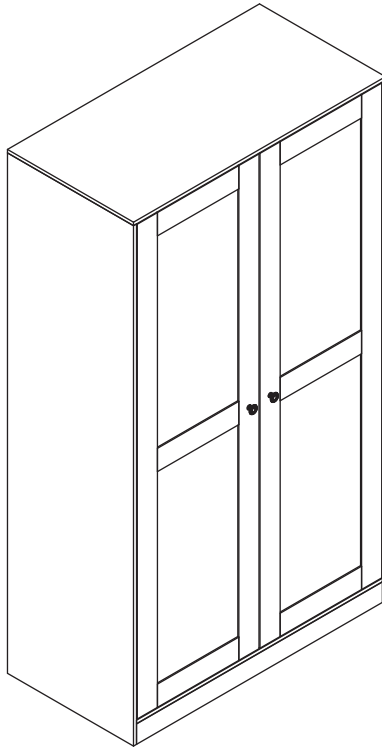

Congratulations! Now you have finished assembling the product.

DOOR ALIGNMENT



Customer Attention:

To align doors and control gap in between doors. Product doors may need adjusting during and after assembly. This can be done by adjusting appropriate screws. See below illustration.

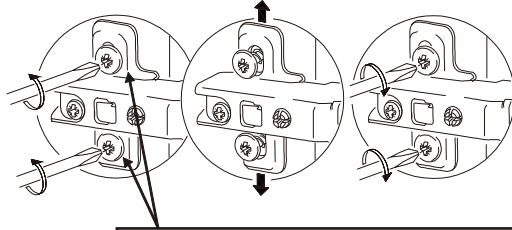
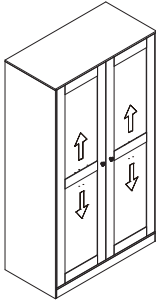

Vertical Door Adjustment:

Loosen both screws on all hinges and lift the door to the desired height. This allows an even space at the top and bottom between the door and frame.

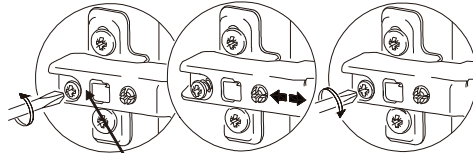
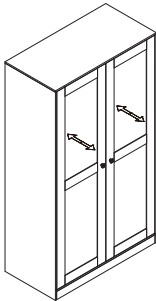

Lateral Door Adjustment:

If door is hinge bound, (rubbing on frame as you close or open door) loosening screw shown and move the door in appropriate direction. (In or out)

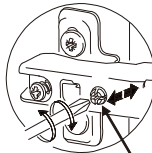
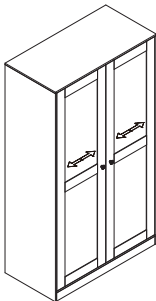

Horizontal Door Adjustment:

Rotate Screw clockwise or anticlockwise. This will produce an even gap between doors and frame.