

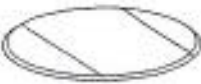











MODEL: Double Drop Leaf Table



Product Complete

No.	Parts List	Qty.	No.	Hardware List	Qty.
P1.	 Table Top	1 pc.	H1.	 Allen Key	1 pc.
P2.	 Pedestal	1 pc.	H2.	 M6 x 40 JCBC Screw	4 pcs.
P3.	 Table Leg	4 pcs.	H3.	 M4 x 32 CSK Screw	5 pcs.
P4.	 Cross Support	1 pc.	H4.	 5/16" Hex Nut	4 pcs.
			H5.	 Spring Washer	4 pcs.
			H6.	 Flat Washer	4 pcs.
			H7.	 Spanner	1 pcs.
			H8.	 Adjuster	4 pcs.

STEP 1

Turn the Pedestal (P2) upside down, attach Table Legs (P3) by Hanger Bolts through pre-drilled holes in Pedestal. Secure it using Flat Washer (H6), Spring Washer (H5) and Hex-Nut (H4). Tighten it with Spanner (H7). Insert the Adjuster (H8) to the bottom of Table Leg (P3).

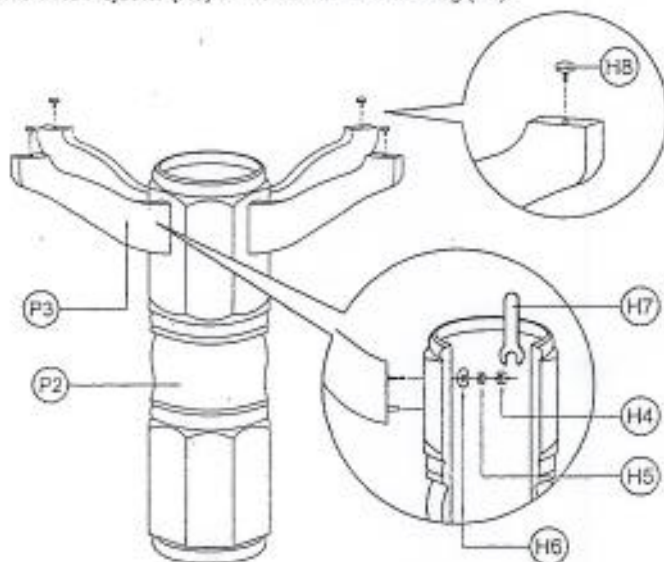

STEP 2

Attach Cross Support (P4) to Pedestal (P2). Secure it using JCBC Screw (H2). Tighten it with Allen Key (H1).

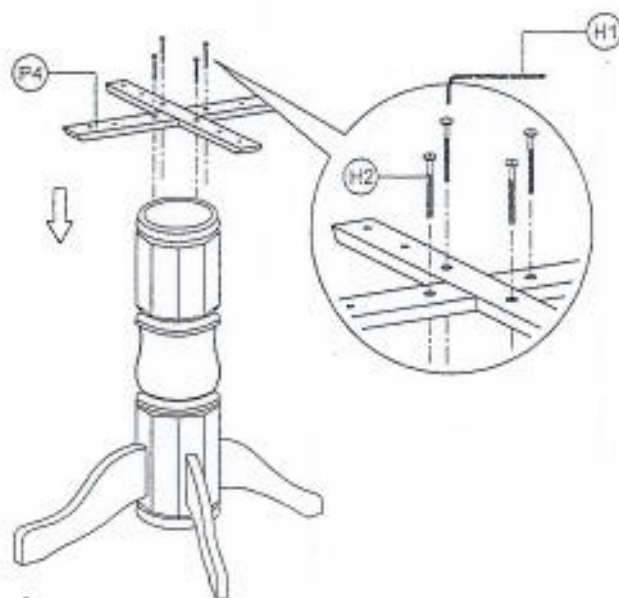

STEP 3

Turn the Table Top (P1) upside down on a soft and flat surface to prevent scratches. Attach the assembled base to the Table Top (P1). Secure it by using CSK Screw (H3).

