

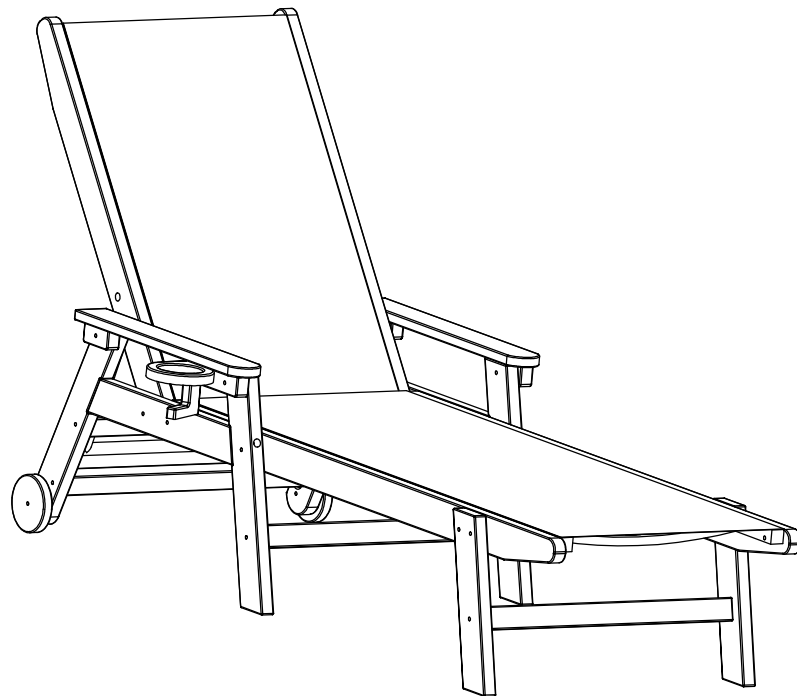

Patio Chaise Lounge

ASSEMBLY MANUAL



MODEL#:LLFT9393

Missing part? Damaged? Contact us via email at

service@domioutdoorliving.com

www.domioutdoorliving.com







BEFORE STARTING ASSEMBLY



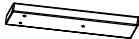

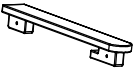

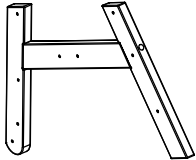
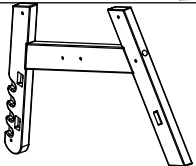
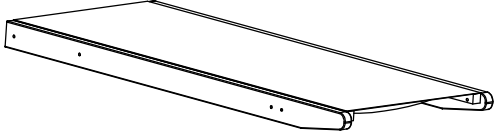
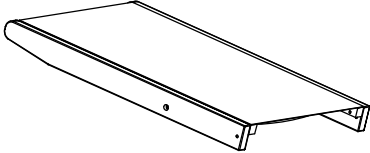

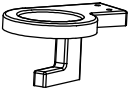
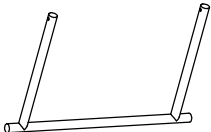
- ① Please check all parts and components to ensure that there are no damages or missing items BEFORE starting the construction of the product.
- ② For ease of construction, you may need a Power Drill (Cordless, Variable Speed).
- ③ It would be much easier to assemble the product with two or more people.
- ④ Some parts have metal edges. Please be careful when handling components.

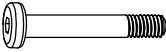
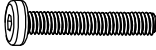
IMPORTANT: Please contact Customer Service if you have any problems or discover any missing parts.

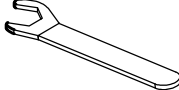

USA & Canada:
1-833-807-3550

A		1
B		1
C		4
D		1
E		1
F		1
G		1
H		1
I		1
J		2
K		1
L		1

1	 <p>M6X60</p>	10
2	 <p>M6X55</p>	6
3	 <p>M6X50</p>	2
4	 <p>st6*60</p>	8
5	 <p>M6X30</p>	1
6	 <p>D6</p>	18
7	 <p>M6</p>	18
8		1
9	 <p>S4</p>	1

(D)	1X	
(E)	1X	
(F)	1X	
(G)	1X	
(2)	4X	M6X55
(6)	4X	D6
(7)	4X	M6
(8)	1X	
(9)	1X	S4

Step1

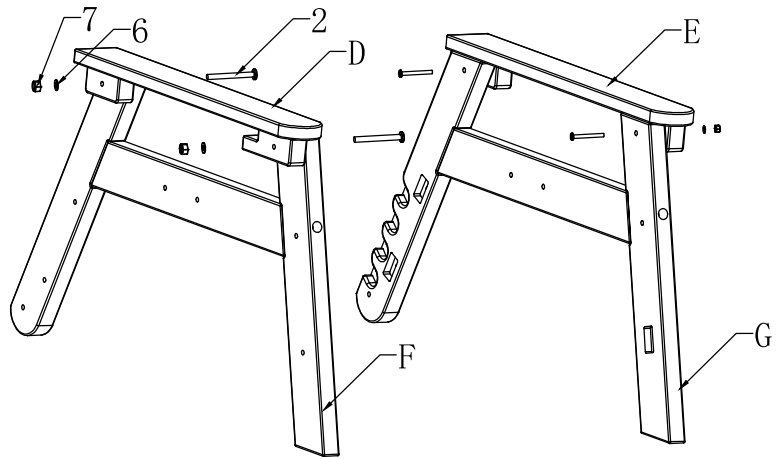

Attach Armrest #D & #E to Leg #F & #G with 4 Bolts#2, Washers#6 and Nuts#7.

(C)	3X	
(4)	6X	st6*60
(9)	1X	S4

Step2

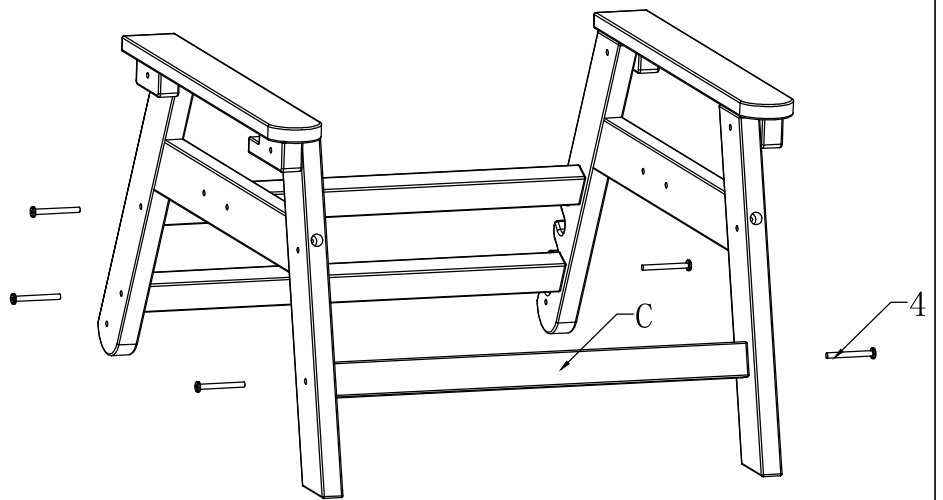

Connect the 2 installed parts with 3 Braces #C, and secure them with 6 Screws#4.

(K) 1X

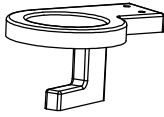

(5) 1X



M6X30

Step3

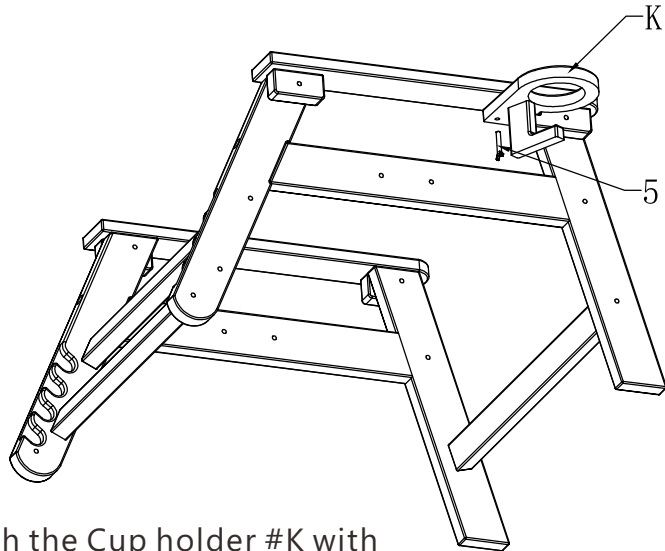

Attach the Cup holder #K with Bolt #5.

(A) 1X

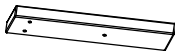

(B) 1X



(C) 1X



(4) 2X



st6*60

Step4

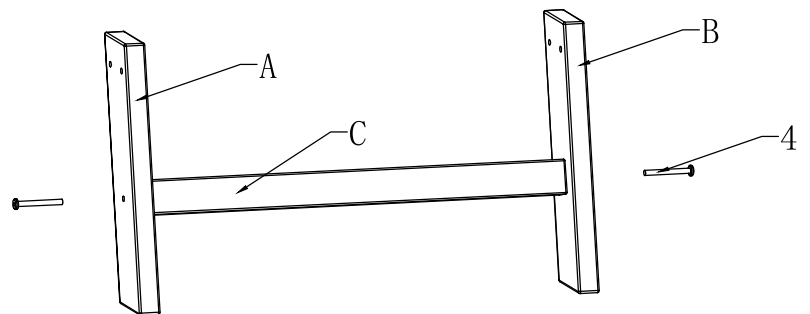

Attach Brace #C to Leg #A & #B with 2 Screws #4.

(9) 1X



S4

Step5

H 1X

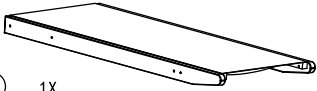

1 8X M6X60

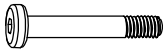

6 8X D6



7 8X M6



8 1X

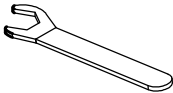

9 1X S4

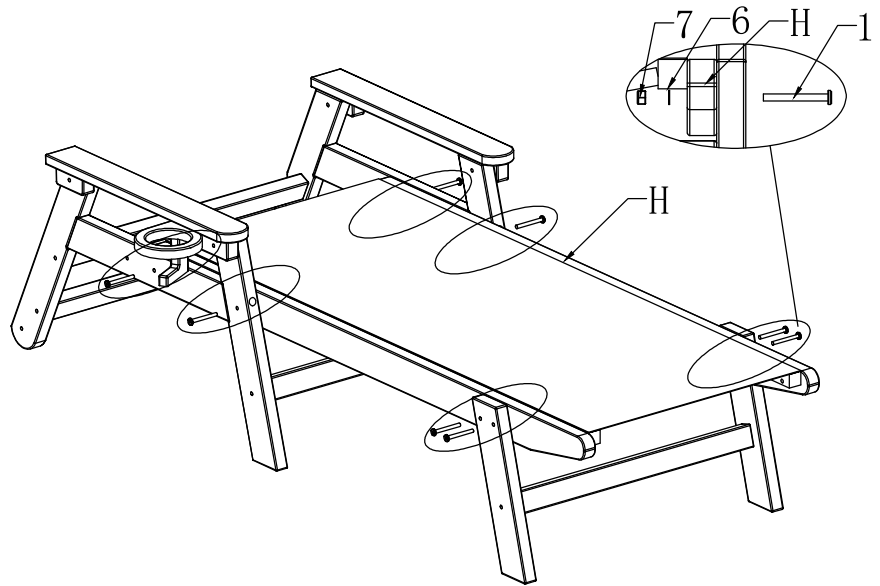
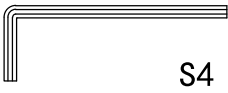

Attach the Seat Part#H to assembled related structure with 8 Bolts#1, Washers#6 and Nuts#7.

Step6

I 1X

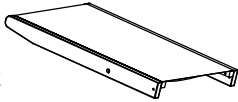

J 2X

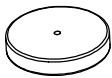

1 2X M6X60

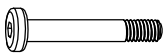

2 2X M6X55



6 4X D6



7 4X M6



8 1X

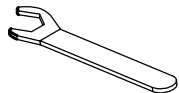

9 1X S4

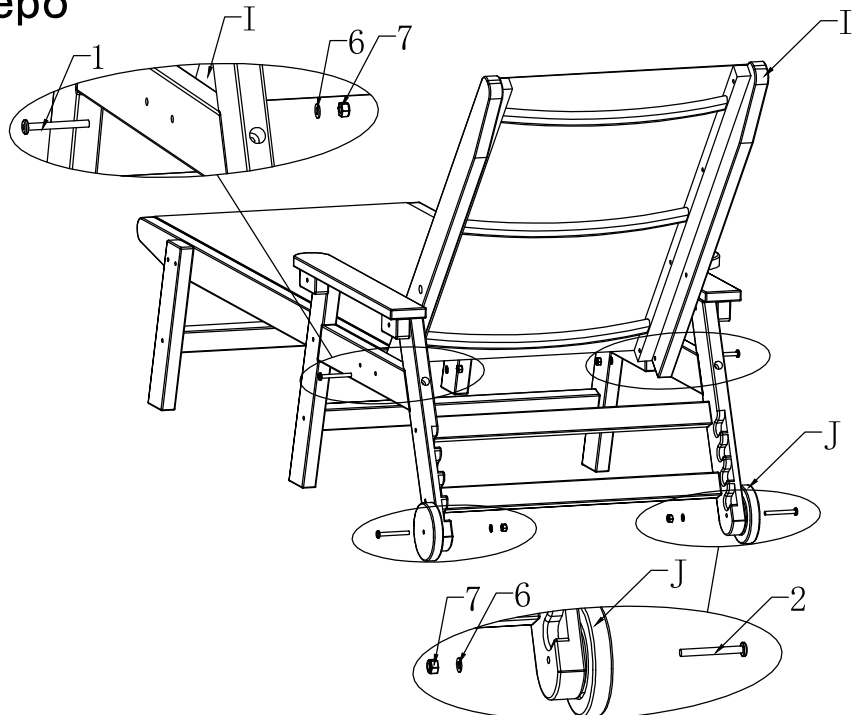

(1) Attach Backrest #I with 2 Bolts#1, Washers#6 and Nuts#7.

(2) Attach the Wheels#J to the bottom of the chair with 2 Bolts#2, Washers#6 and Nuts#7.

Ⓛ 1X

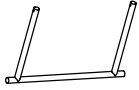

③ 2X



M6X50

⑥ 2X



D6

⑦ 2X



M6

⑧ 1X

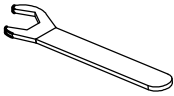

⑨ 1X

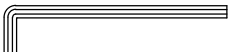

S4

Step7

Attach Support Part#L with 2 Bolts#3,
Washers#6 and Nuts#7.

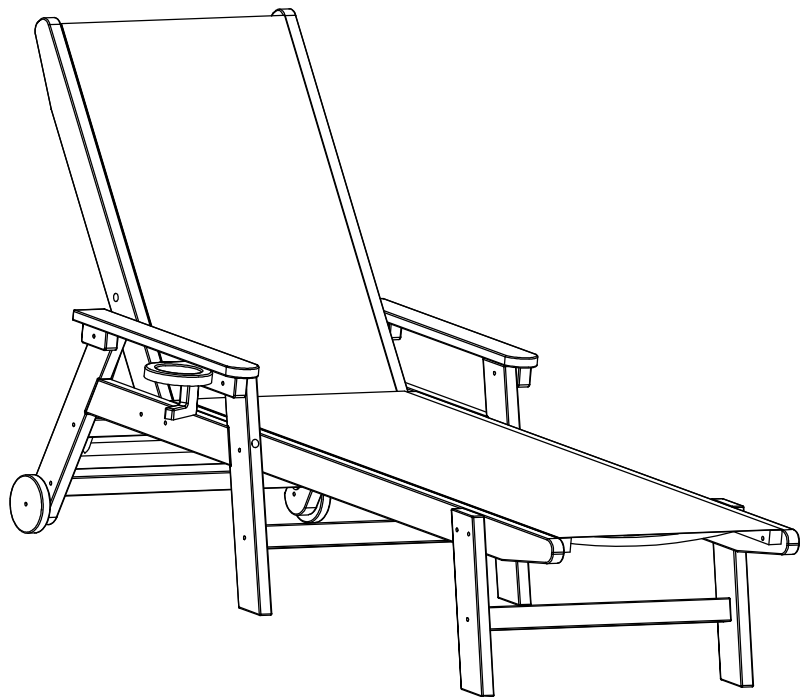
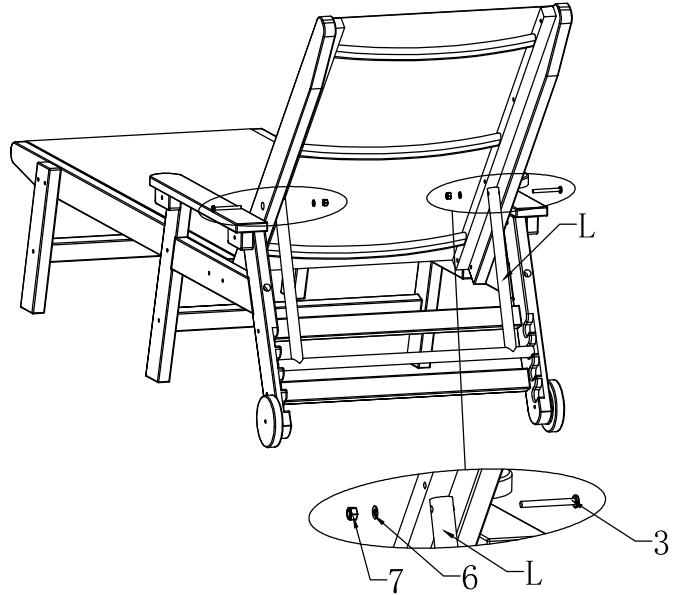



Thanks for your purchase.

At domi outdoor living, we believe in our products.

That's why we provide a 12-month warranty and friendly, easy-to-reach after-sales service. So, if you have any questions about our product or assembly, please feel free to contact us. We are here for you.

Support:  

After-sales contact email:

service@domioutdoorliving.com

Business cooperation contact email:

marketing@domioutdoorliving.com

Please have your order ID available if you reach out for support.

If you have damaged parts or product, please send us photos for an immediate response.