

ASSEMBLY INSTRUCTIONS

DESK CHAIR

PARTS INCLUDED

(A) CHAIR TOP (×1 piece)



(B) GAS LIFT (×1 piece)

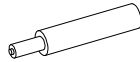

(C) 5-STAR BASE (×1 piece)

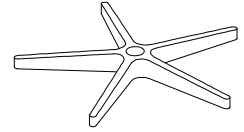

(D) CASTERS (×5 pieces)



ASSEMBLY INSTRUCTIONS

1. Carefully unpack the parts from the carton.
2. Put the 5-Star Base (C) on a flat surface with top down. (Note: Cover the work surface with a protective material to prevent damage to it and the chair base.) Attach the Casters (D) underneath the 5-Star Base (C) (shown in Figure 1).

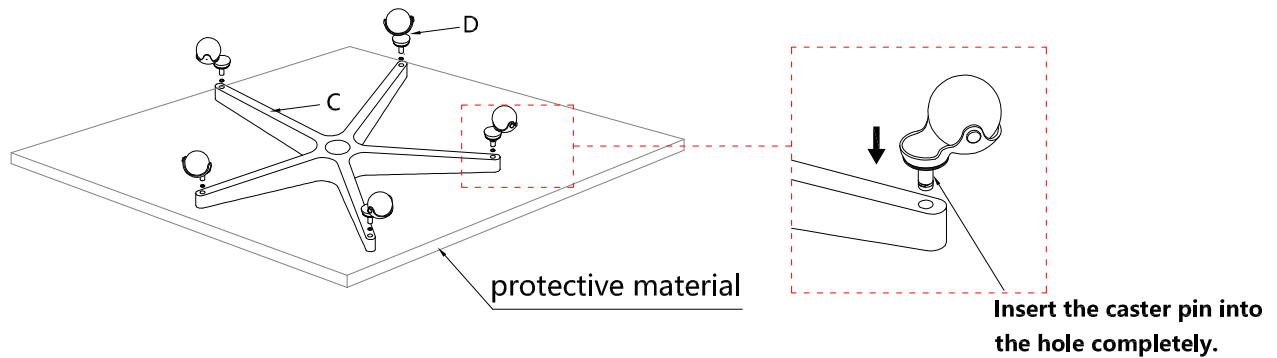

Figure 1

3. Turn the chair base upright (shown in Figure 2).

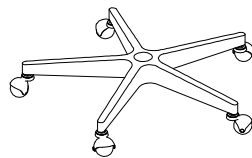

Figure 2

ASSEMBLY INSTRUCTIONS

DESK CHAIR

4. Remove the blue plastic dust cover cap from the top of the Gas Lift (B) (shown in Figure 3) and attach the Gas Lift to the 5-Star Base (C) (shown in Figure 4).

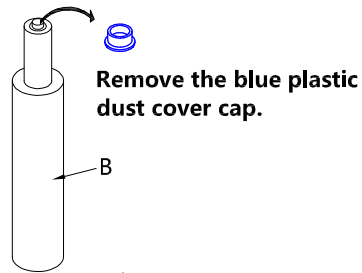

Figure 3

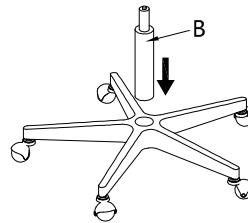

Figure 4

5. Attach the Chair Top (A) (already pre-assembled swivel plate underneath) onto the assembled base (shown in Figure 5).

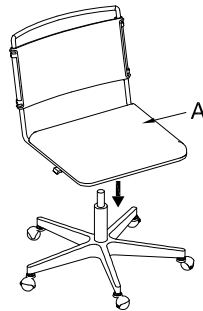

Figure 5

6. Adjust the chair's height by pulling up on the trigger at the bottom of the Chair Top (A) (shown in Figure 6).

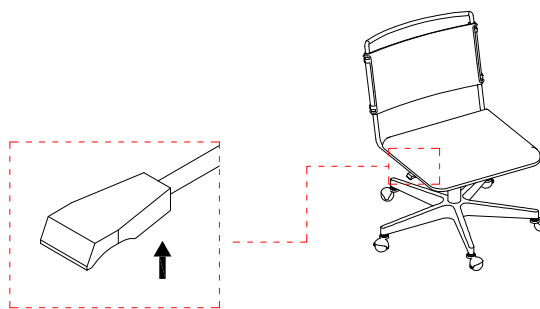

Figure 6

CARE INSTRUCTIONS

1. Clean periodically by wiping the furniture lightly with a soft, dry cloth.
2. Do not use abrasive or chemical cleaners, as they may damage the finish.