

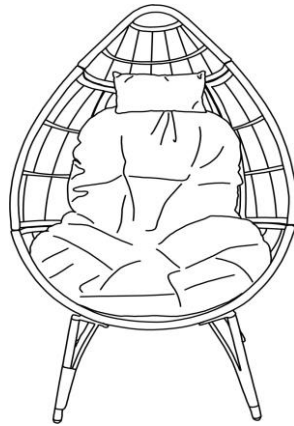



# Assembly Instructions



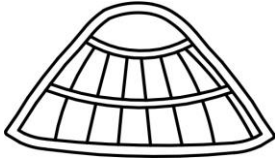

Caution: You must read this before you proceed.

## Basket Chair



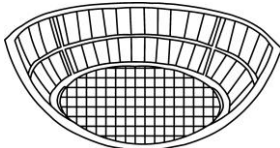





### Parts List

Label	Picture	Description	QTY
A		Top Panel	1
B		Left Panel	1
C		Left Panel	1
D		Right Panel	1

E		Right Panel	1
F		Seat Panel	1
G		Front Leg	2
H		Back Leg	2
J		Cushion	1
K		Pillow	1

## Hardware





Label	Picture	Description	QTY
①		Allen Key	1
②		Bolt (M6x30mm)	20
③		Bolt (M6x16mm)	13
④		Washers	33

⑤		Nut Cap	20
⑥		Pre-installed Leveller	1

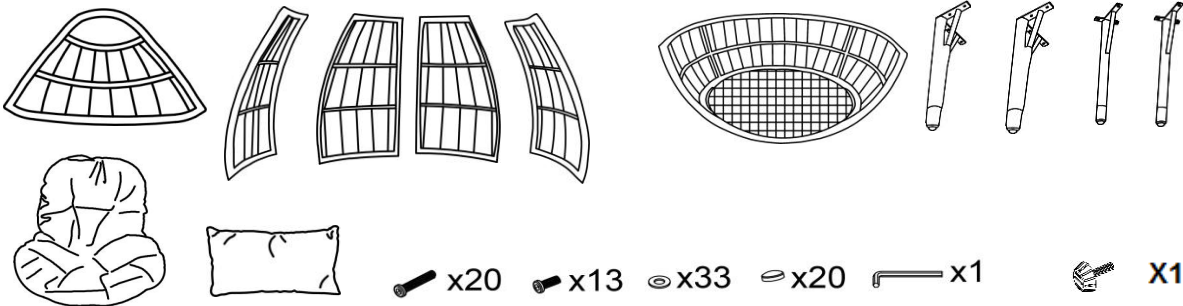
## Assembly Preparation

Before Beginning Assembly:



-  • Read instructions, cover to cover-
-  • Have 2 adults on hand for assembly-
-  • Do not assemble on flooring or carpet-
-  • Assemble on a clean non-marring surface (packing foam)-
-  • Save all packaging until finished-

## Assembly Steps

### Overview

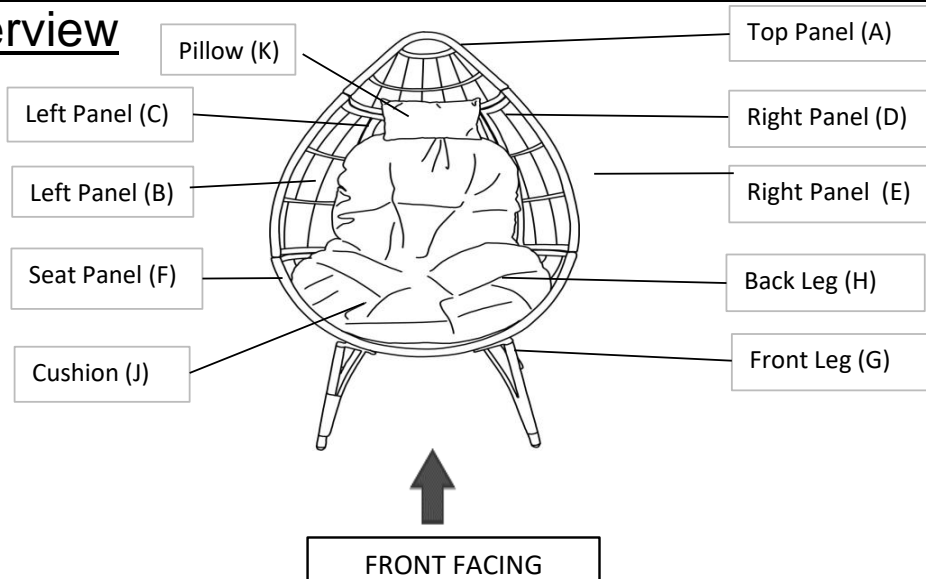

This Chair has multiple parts and may require up to some 30 minutes to assemble. To give you an overview of the Chair parts, the above picture is to help you put the various parts into perspective. Please read through the instructions below to familiarise yourself with the parts and steps before assembly.

## Step 1

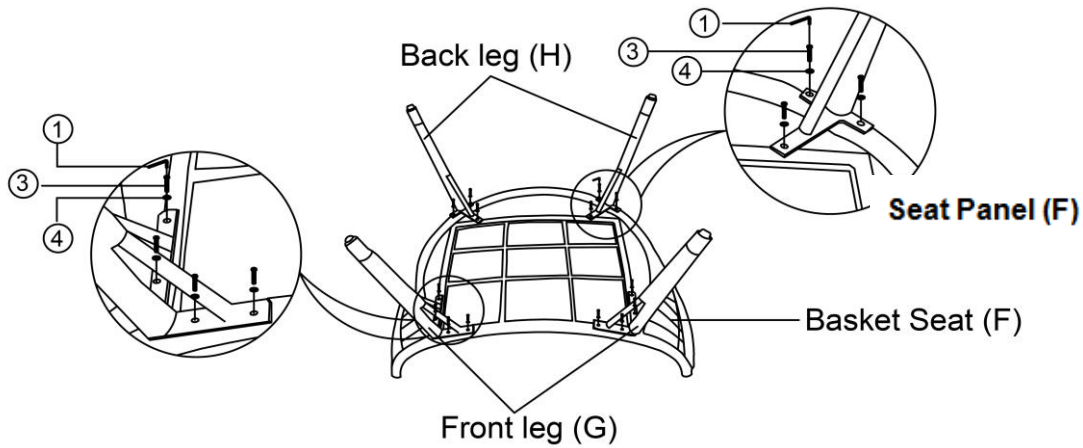

Open the carton and place all the parts onto a clean, non-marring surface.  
Place the Seat Panel (F) on the ground, as shown in picture above. Attach the two Front Legs (G) and the Back Legs (H) to the Seat Panel (F) using Bolts (3) and Washers (4) with the Allen Key (1) as shown in the picture above.

**Do not fully tighten the bolts.**

## Step 2

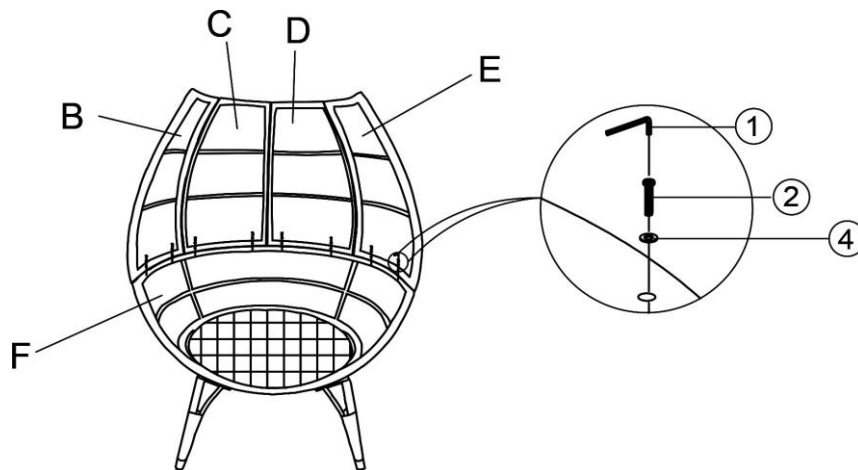

Turn the Seat Panel (F) over as shown in picture.

Attach the Left Panel (B), (C) and the Right Panel (D), (E) to the Seat Panel (F) using Bolts (2) and Washers (4) with the Allen Key (1) as shown in the picture above.

**Do not fully tighten the bolts.**

### Step 3

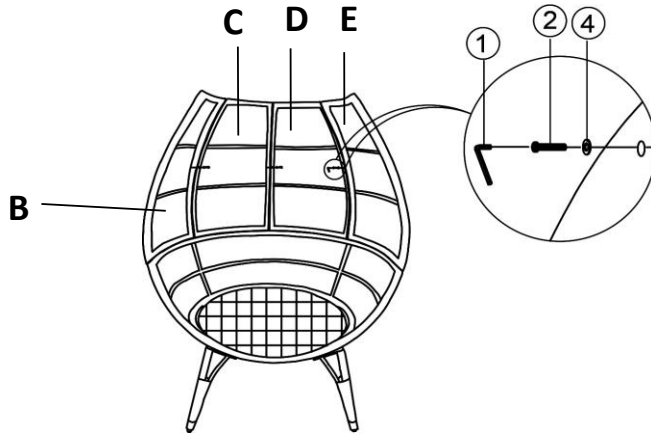

Attach the Left Panel (B), (C) to the Right Panel (D), (E) using Bolts (②) and Washers (④) with the Allen Key (①) as shown in the picture above.

**Do not fully tighten the bolts.**

### Step 4

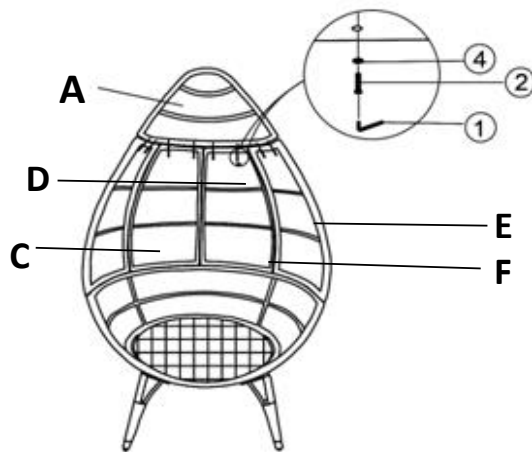

Attach the Top Panel (F) to the Left Panel (C), (D) and the Right Panel (E), (F) using Bolts (②) and Washers (④) with the Allen Key (①) as shown in picture above.

**Do not fully tighten the bolts.**

### Step 5

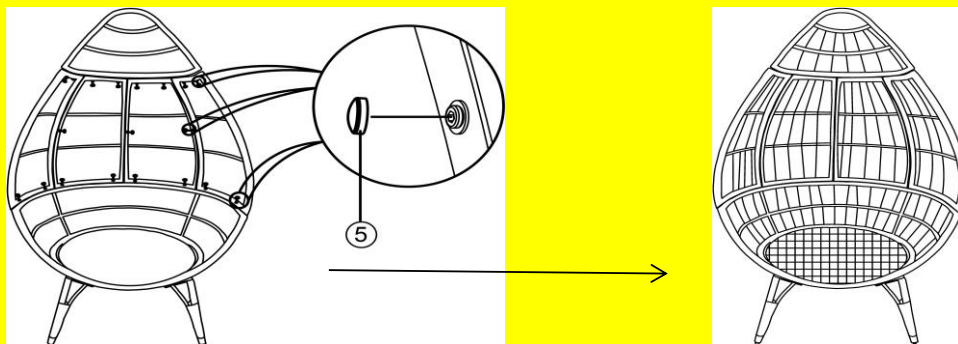

Add the Nut Caps (⑤) onto the Bolts as shown in the picture above.

In the end, check for stability and then tighten all Bolts at all joints.

**Note: DO NOT fully tighten a Bolt in one go and then move on to the next.**





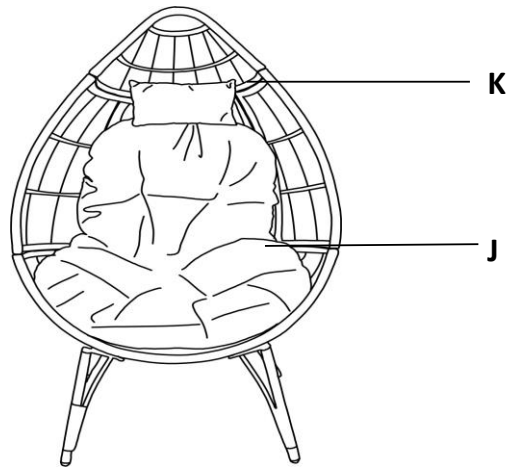















**Rather, in a sequential manner, gradually tighten each Bolt until all Bolts are evenly secured. This methodology will ensure maximum evenness once all Bolts are fully tightened.**

## Step 6



Place the Cushion (J) and the Pillow (K) on the Basket.  
Your Basket Chair is ready for use.

### Care & Maintenance

-   ● Do not put hot items directly on furniture surface
-   ● Do not clean furniture with harsh cleansers or polish.
-   ● To obtain the longest lifespan of your outdoor products, minimizing exposure to direct sunlight is recommended.
-   ● Children should not climb or jump on the furniture.
-   ● Do not write on furniture without a padded barrier to protect the surface.
-   ● To obtain the longest lifespan of your outdoor products, avoid extended and lengthy exposure to rain, snow, and direct sunshine. Whenever possible cover the product and /or place under patio or awnings.
-   ● Not for commercial use. For residential use only .
-   ● Stains may be removed with mild soap solution and damp cloth.
-   ● Keep away from sources of ignition.
-   ● Dust and pick-up spills using a clean, non-colored, lint-free cloth.