

BENCH

ASSEMBLY GUIDE

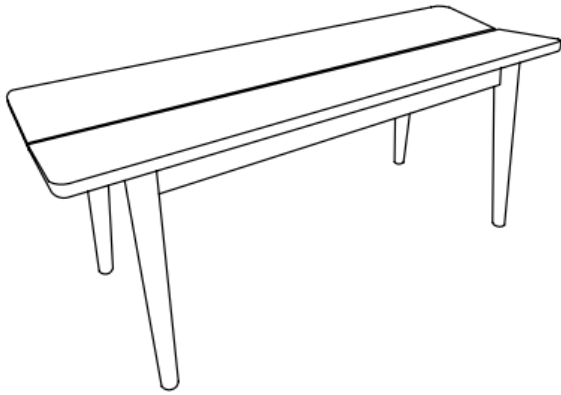

Important - Please read these instructions fully before starting assembly



SAFETY AND CARE ADVICE



NO POWER TOOLS

SAFETY AND CARE ADVICE

- Check you have all the components and tools listed.
- Remove all fittings from the plastic bags and separate them into their groups.
- We do not recommend the use of power drills/drivers for inserting screws, as this could damage the unit. Only use hand screwdrivers and Allen keys.
- Keep children and animals away from the work area, small parts could cause choking if swallowed.
- Make sure you have enough space to lay out the parts before starting.
- Assemble the item as close to its final position (in the same room) as possible.
- Do not overtighten the nuts to avoid causing damage to the threads.
- Only clean using a damp cloth and mild detergent, do not use bleach or abrasive cleaners.
- From time to time check that there are no loose screws on this unit
- This product should not be discarded with household waste. Take to your local authority waste disposal centre

IMPORTANT INFORMATION



30 MINUTE
BUILD







TWO
PERSON



MAXIMUM
CAPACITY
120Kg

PLEASE CHECK CAREFULLY AND MAKE SURE YOU HAVE ALL FITTINGS AND TOOLS LISTED BELOW BEFORE YOU START.

LIST OF PARTS		
No	Description	Qty
1	Bench Top	1 PC
2	Bench Legs	4 PCS

HARDWARE LIST			
No	Description		Qty
A	JCBC BOLT		8 PCS
B	Spring Washer		8 PCS
C	Flat Washer		8 PCS
D	Allen Key		1 PC

NOTE: The quantities above are the correct amount to complete the assembly for 2x chairs. In some cases more fittings may be supplied than are required.

STEP 1

Use a clean, flat, soft surface to avoid any bumps or scratches.

Place Bench top [1] upside down on the flat surface and align 4 x bench legs [2] with the pre drilled holes.

Secure the legs in place using 8 x flat washer [C], spring washer [B] and bolt [A] - 2 sets of fixings per leg.

Tighten using Allen key [D], ensure not to over tighten the bolts.

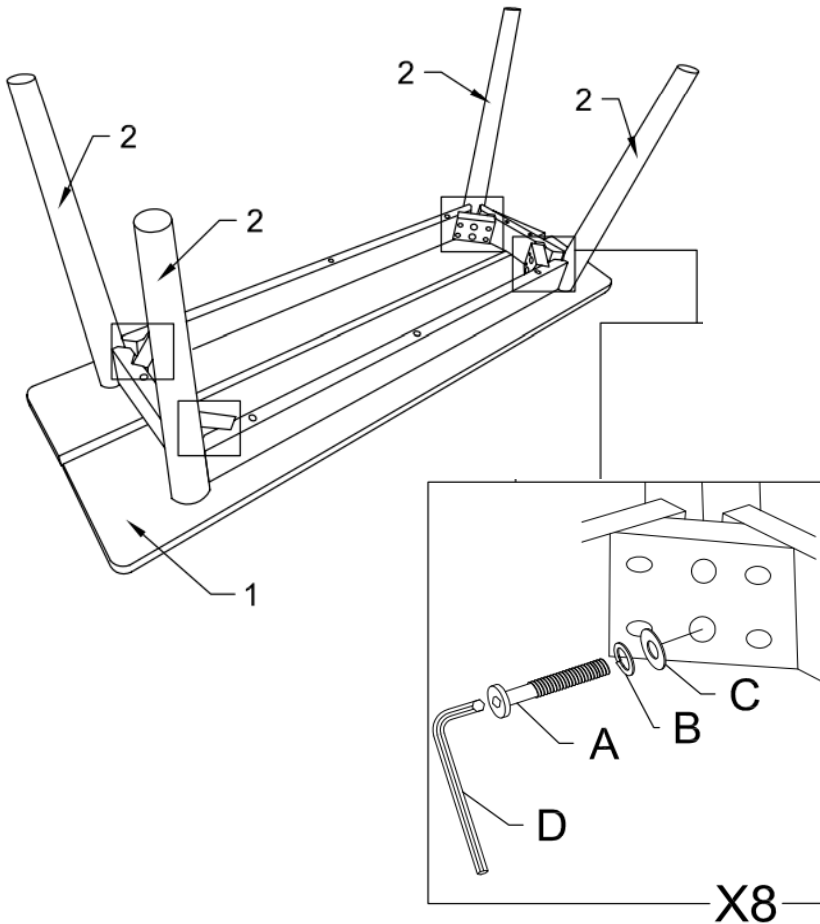

STEP 2

Carefully, and with help, flip the bench upright on to the legs. .
Check the stability.

Your Bench is now ready to use!

NOTE: This bench is not suitable to stand on.

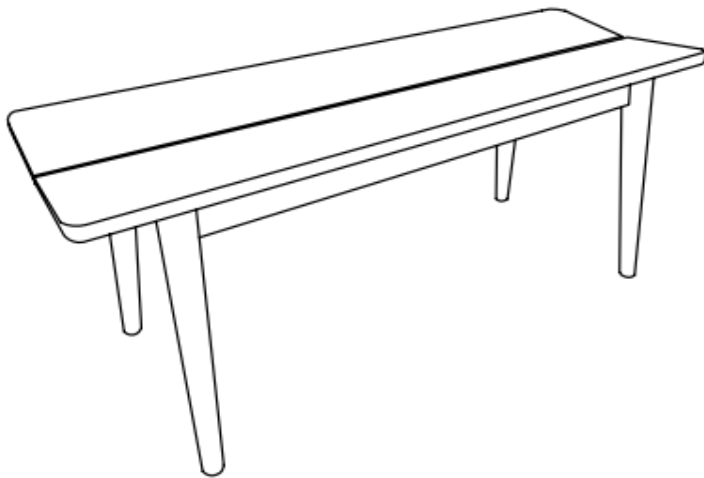



OUR 2 YEAR GUARANTEE



WHAT THE GUARANTEE COVERS



PRE-INSERTED FIXINGS

e.g. loose metal threads



FAULTY JOINTS

e.g. legs bending



EXTERNAL FIXING FAULTS

e.g. metal discs removing
from table top



STRUCTURAL INTEGRITY

e.g. the frame of the
product