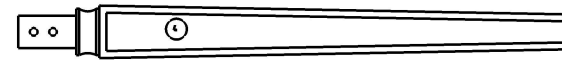
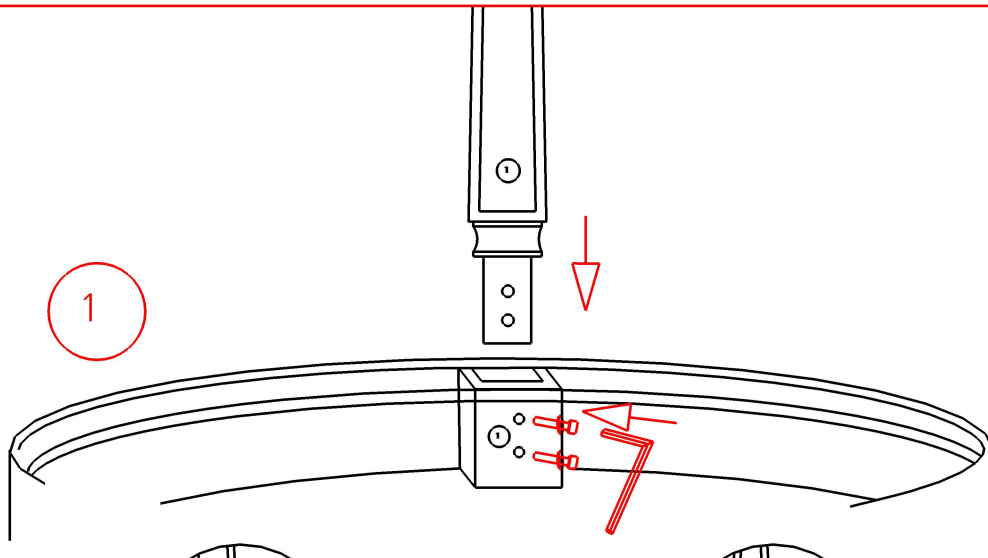
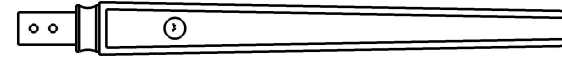


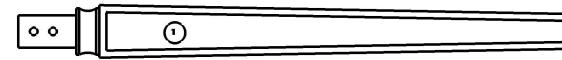
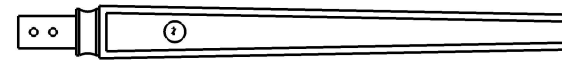
Installation Instructions



Allen Wrench 1pcs



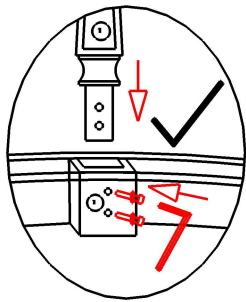
Handle Bolt 8pcs



legs 4 pcs

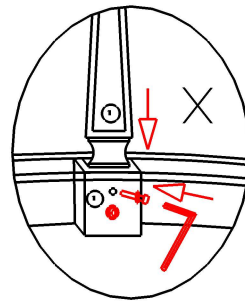


table top 1pcs



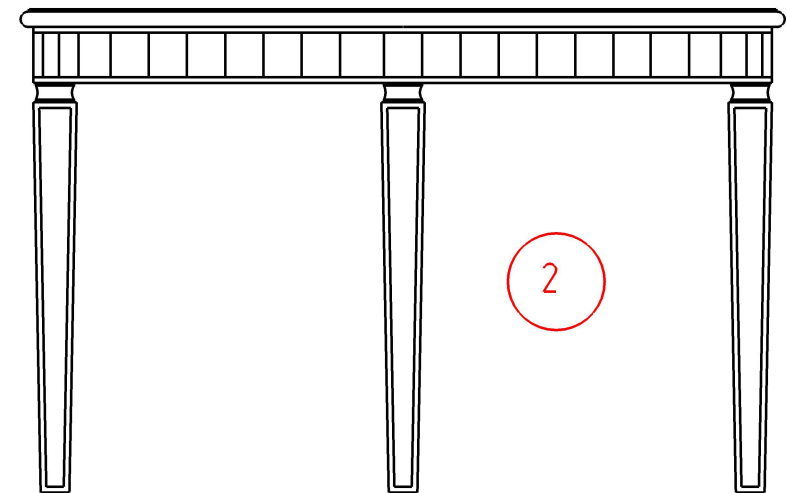
Right Method:

Put 2 screws into the holes at the same time, and tighten them.



Wrong Method:

After tightening one, place the other screw in the hole.



”Step 1: According to the code, find the corresponding leg slot.

Step 2: Attach the leg to the table top, put the 2 screws into the holes together, and tighten the 2 screws with a Allen key.

*Note: When installing a leg, do not install another screw after tightening one screw, otherwise the other screw may not be screwed in.