

ASSEMBLY INSTRUCTION



This instruction booklet contains important safety information. please read and keep for future reference.

This sofa collection work as modular sofa function,it can be a single sofa,2seater sofas,3seater sofas,4seater sofas,L shape sofas,ottoman,sofa sets with buying different sections of the sofas and combine them together.You can decide to buy more components according to your living room size.

To ensure safe and satisfactory use of this product,please carefully read the below instructions beforehand.





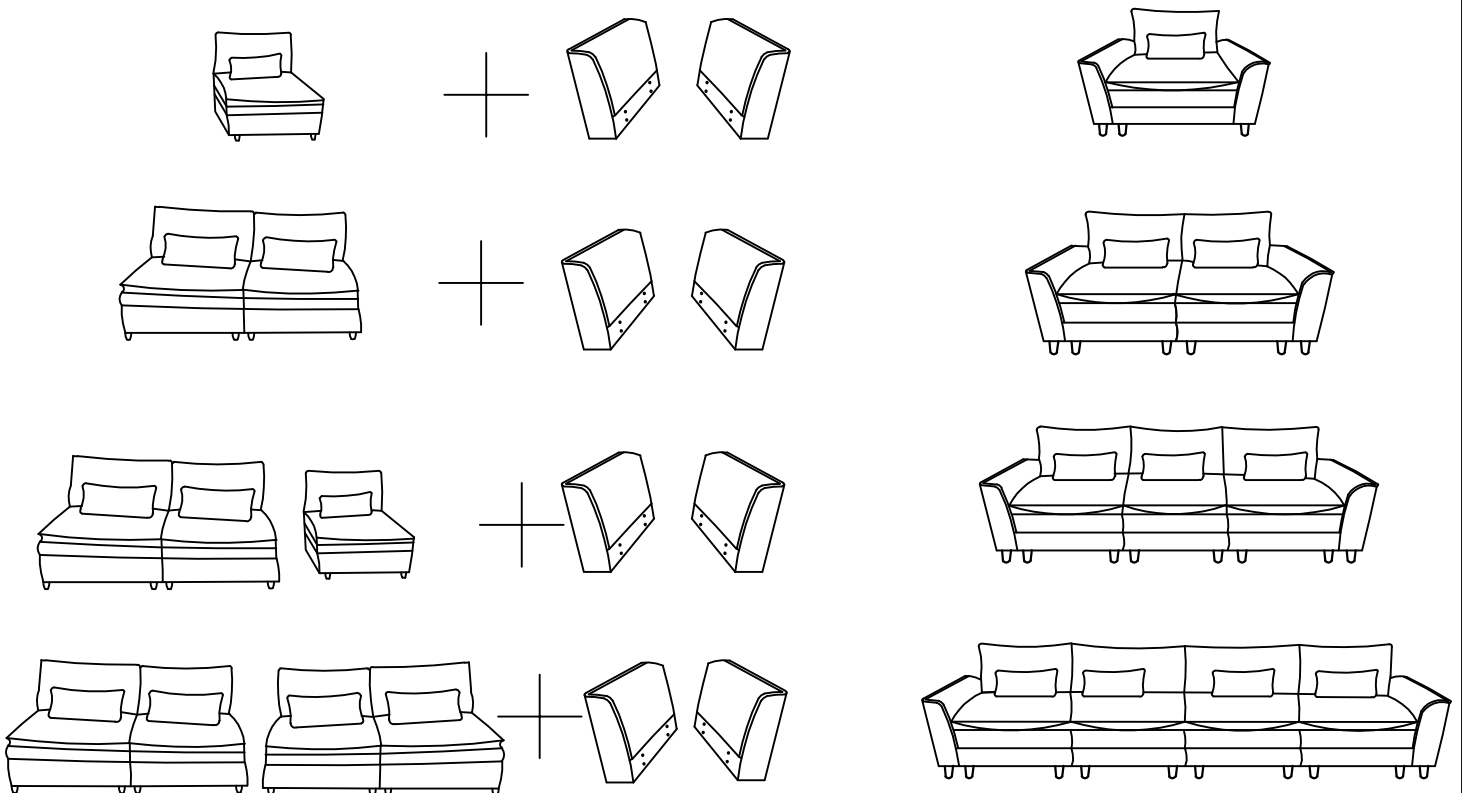



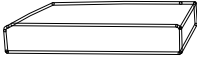

- 1.This sofa ships in several boxes,we recommend unpacking and starting assembly when several boxes are received.
- 2.Our cushions are vacuum packed for convenient shipping. Please allow 2-3days for them to fully expand to their original shape and for any wrinkles to disappear.
- 3.In the event that a part is damaged or missing,no need to return the product,we will gladly help and ship your replacement parts free of charge.

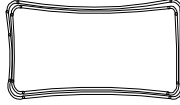
Below are some guidelines for you how you can do mix and match.

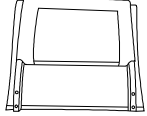

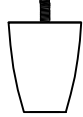

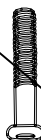
IF YOU BUY A SINGLE SOFA
Please follow below assembly instruction

Parts List (BOX 1)x1

A Seat frame  1PC	B Seat cushion  1PC	C Back Cushion  1PC	E Pillow  1PC
F Backrest  1PC	R Alley Key  1PC	G 9CM Leg  4PC	N Washer M8*22  10PCS
O M8*60mm Bolt  4PCS	P M8*90mm Bolt  3PCS	Q Butterfy Nut  3PCS	

Single sofa do not need to use part P and Q

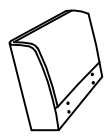
Parts List (BOX 2)x1

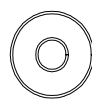
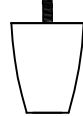
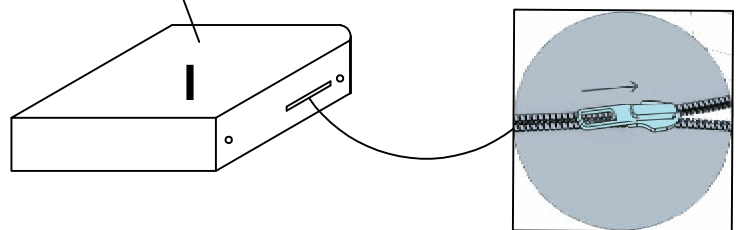
H Left armrest  1PC	I Right armrest  1PC	S M8*50mm Bolt  8PCS	N Washer M8*22  8 PCS
G 9CM Leg  4PC			

Unzip the compartment underneath the Right armrest and pull out the sofa legs.

STEP 1: Assemble the Left armrest (H) and the Right armrest (I) to the Seat frame (A) with Washers (N) and Bolts (S).

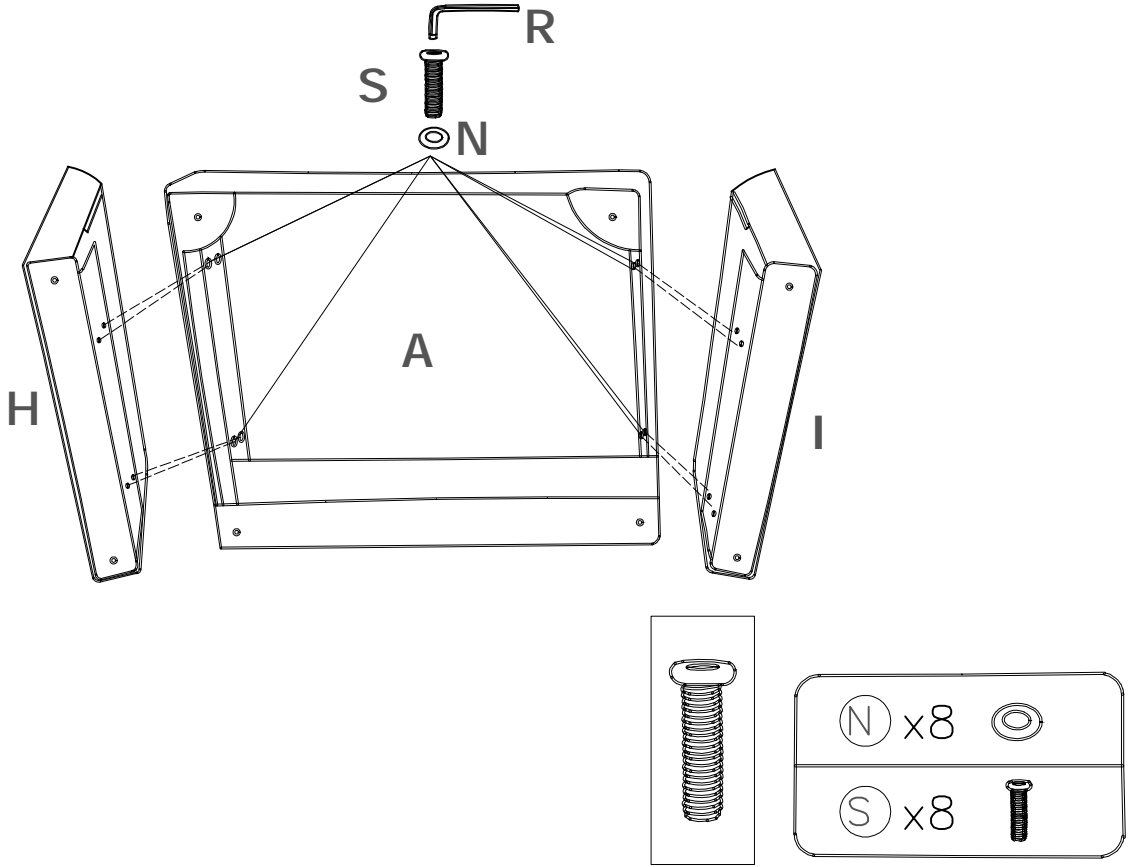

STEP 2: Assemble the Legs (G) on the sofa.

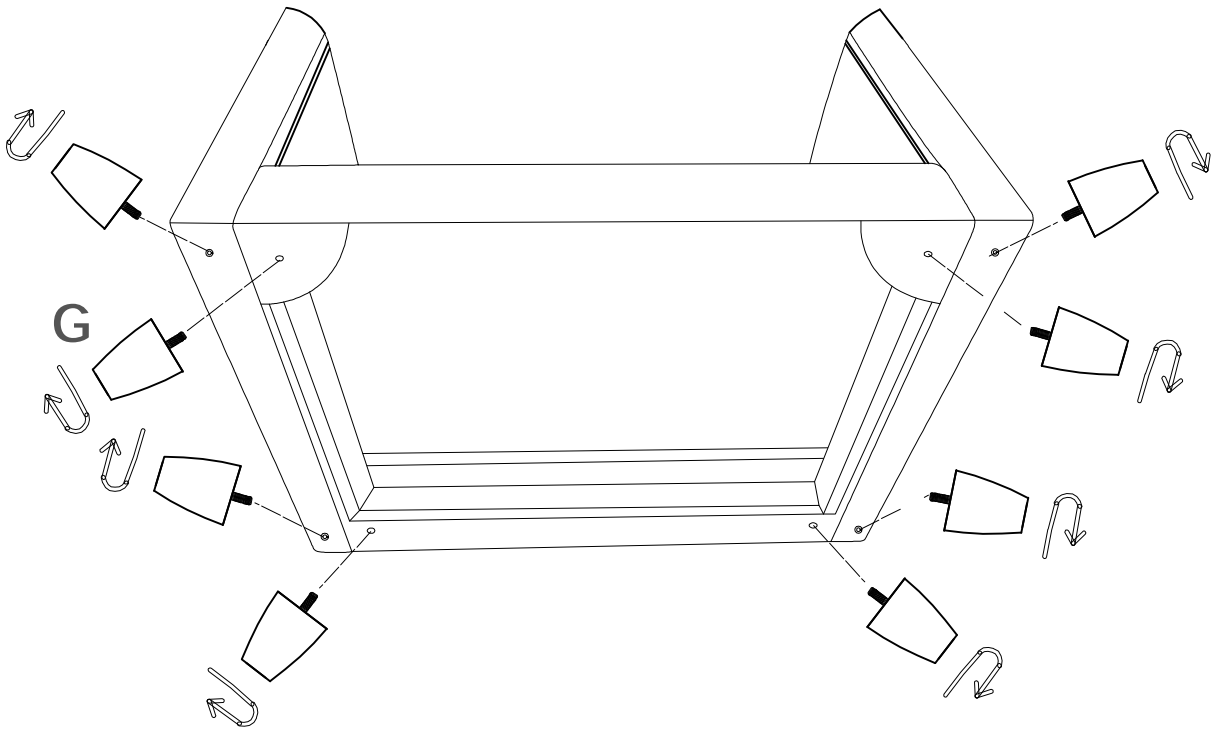

STEP 3: Insert the Backrest (F) into the designated holes, using Washer (N) and Bolts (O) to 70% tightness, and then tighten the all Bolts on the seat.

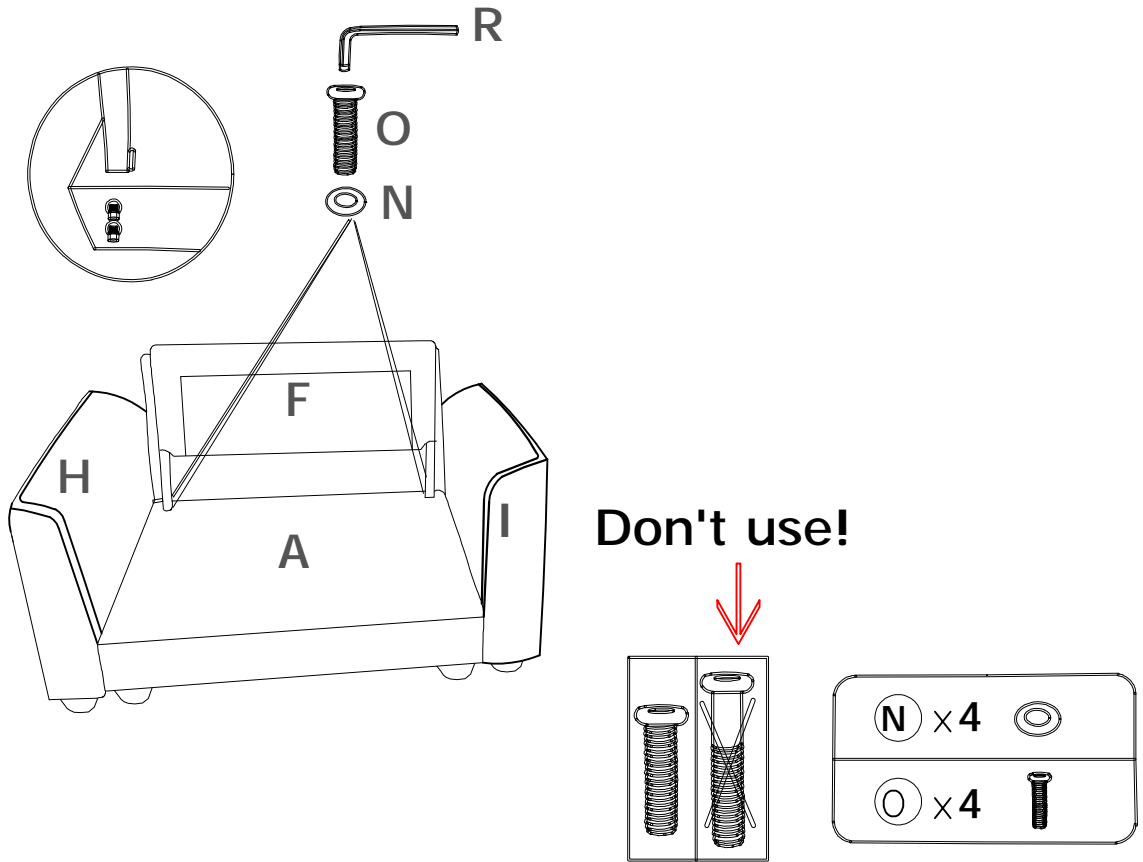

STEP 4: The cushion is packaged by vacuum compression. After cutting the package, it rebounds quickly within 4 hours. If the fabric has wrinkles, it will basically disappear after standing for 72 hours

Pat around evenly plump

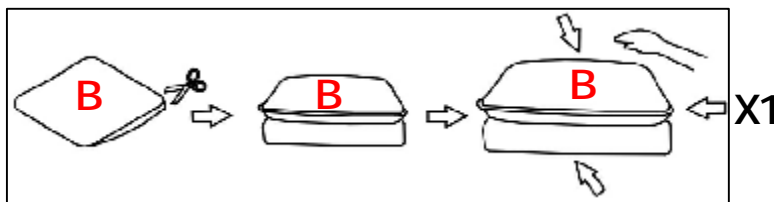

Pat around evenly plump

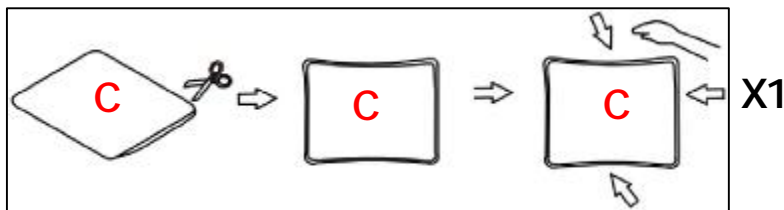

STEP 5: Place Seat cushions (B) and back cushions (C), and make sure it's will fitted.

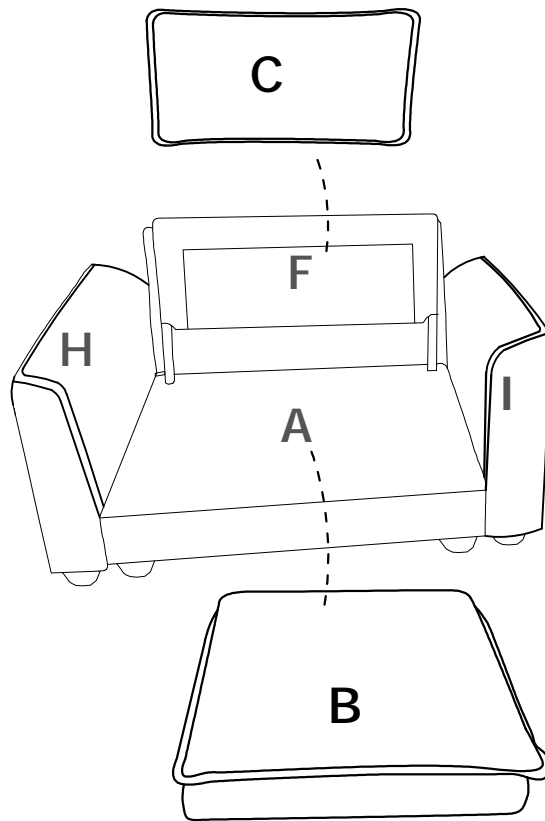



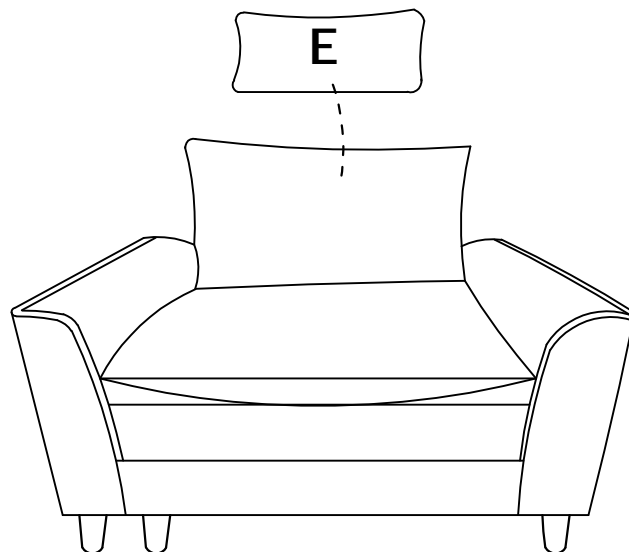





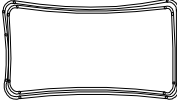

STEP 6: Place Pillows (E) on sofa and make sure it's will fitted.

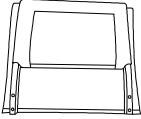





IF YOU BUY 2 SEATER SOFA
Please follow below assembly instruction

Parts List (BOX 1)x2

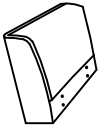
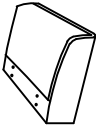
A Seat frame  2PC	B Seat cushion  2PC	C Back Cushion  2PC	E Pillow  2PC
F Backrest  2PC	R Alley Key  2PC	G 9CM Leg  8PC	N Washer M8*22  20PCS
O M8*60mm Bolt  8PCS	P M8*90mm Bolt  6PCS	Q Butterfy Nut  6PCS	

Parts List (BOX 2)x1

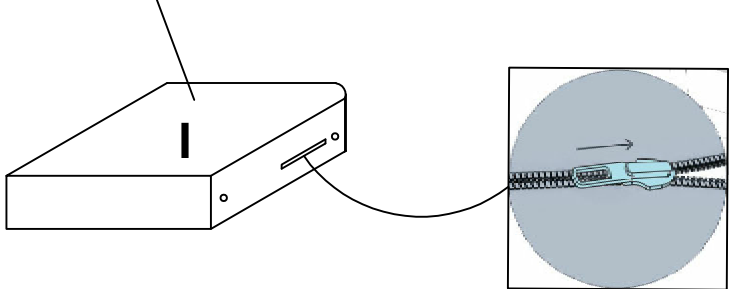
H Left armrest  1PC	I Right armrest  1PC	S M8*50mm Bolt  8PCS	N Washer M8*22  8 PCS
G 9CM Leg  4PC			

Unzip the compartment underneath the Right armrest and pull out the sofa legs.

STEP 1: Assemble the Left armrest (H) to the Seat frame (A) with Washers (N) and Bolts (S).

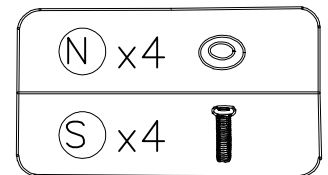
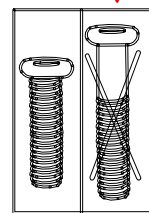
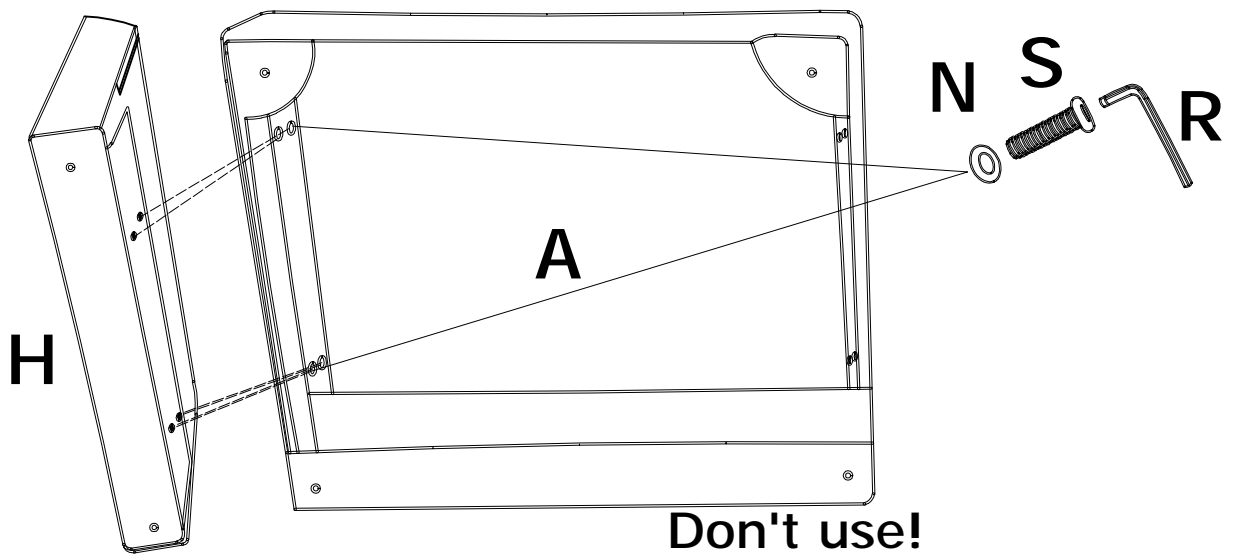

STEP 2: Assemble the Right armrest (I) to the Seat frame (A) with Washers (N) and Bolts (S).

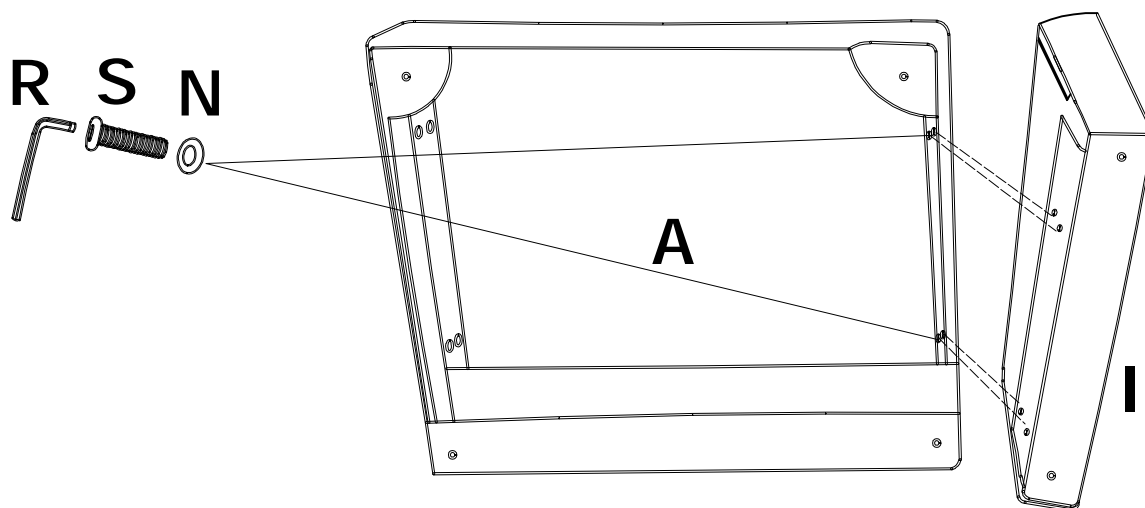

Don't use!

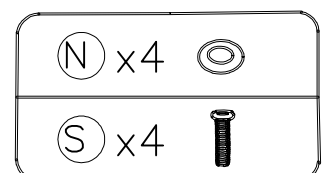
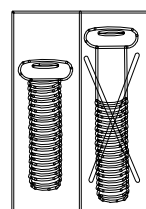

STEP 3: Assemble Seat frame (A) and Seat frame (A)with Butterfly nuts (Q) Washers (N) and Bolts (P).

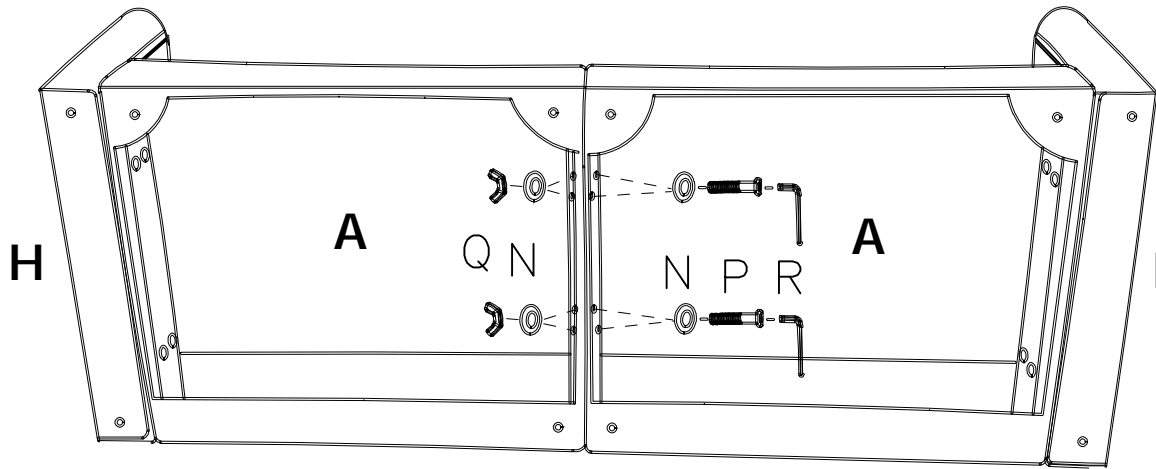

Don't use!

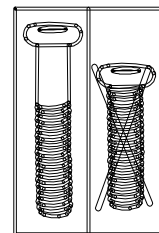

N 8	
P x 4	
Q x 4	

STEP 4: Assemble the Legs (G) on the sofa.

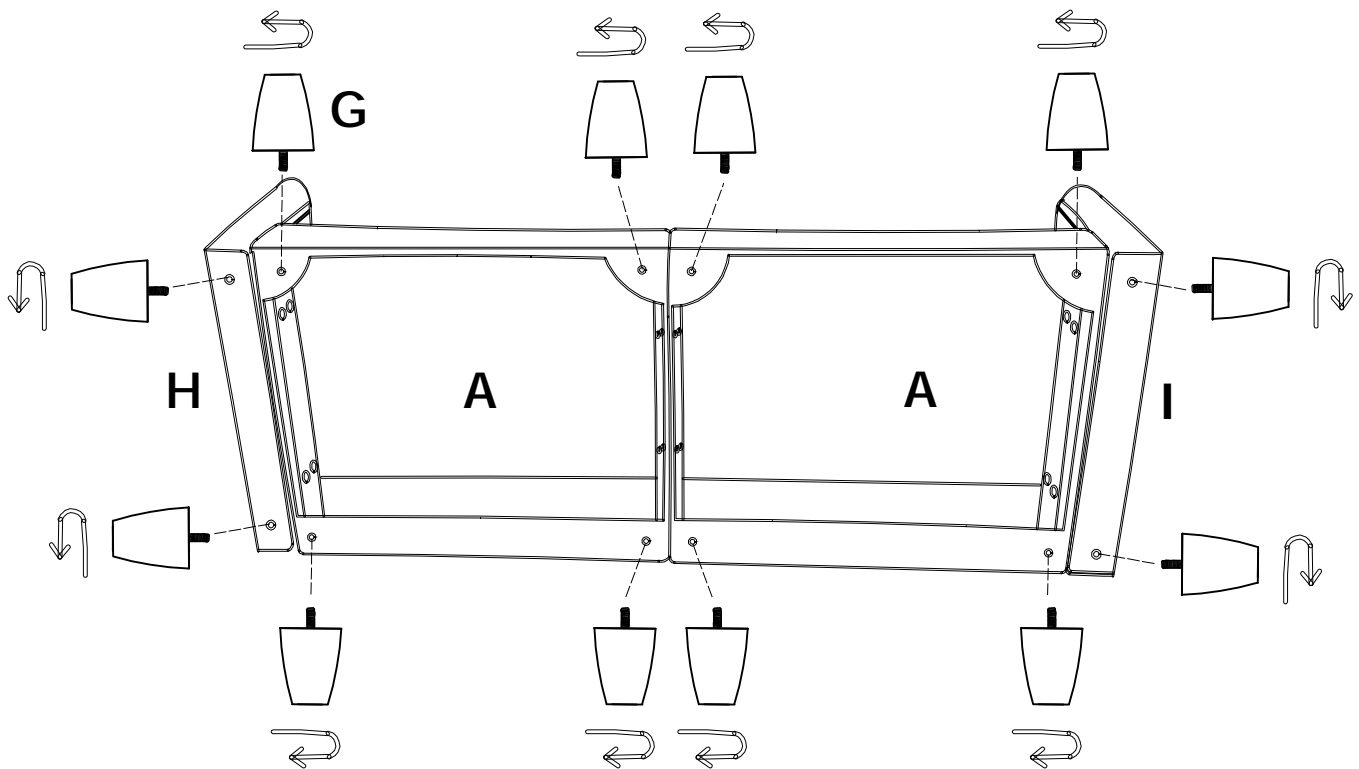

STEP 5: Insert the Backrest (F) into the designated holes, using Washer (N) and Bolts (O) to 70% tightness, and then tighten the all Bolts on the seat.

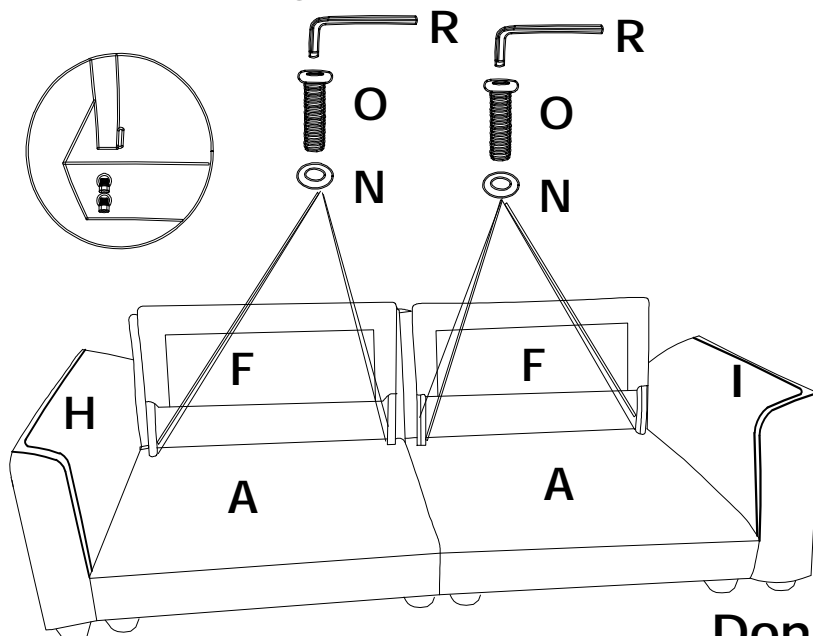

Don't use!

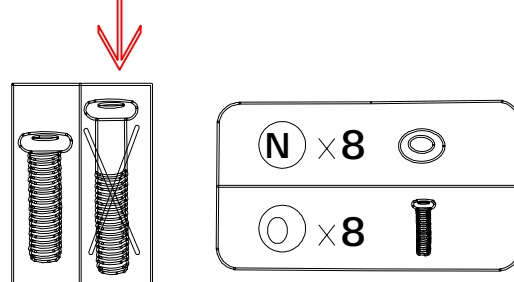

STEP 6: The cushion is packaged by vacuum compression. After cutting the package, it rebounds quickly within 4 hours. If the fabric has wrinkles, it will basically disappear after standing for 72 hours

Pat around evenly plump

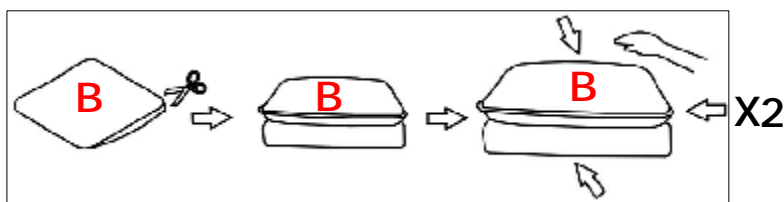

Pat around evenly plump

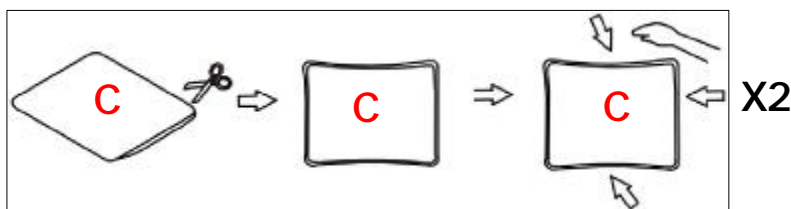

STEP 7: Place Seat cushions (B) and back cushions (C), and make sure it's will fitted.

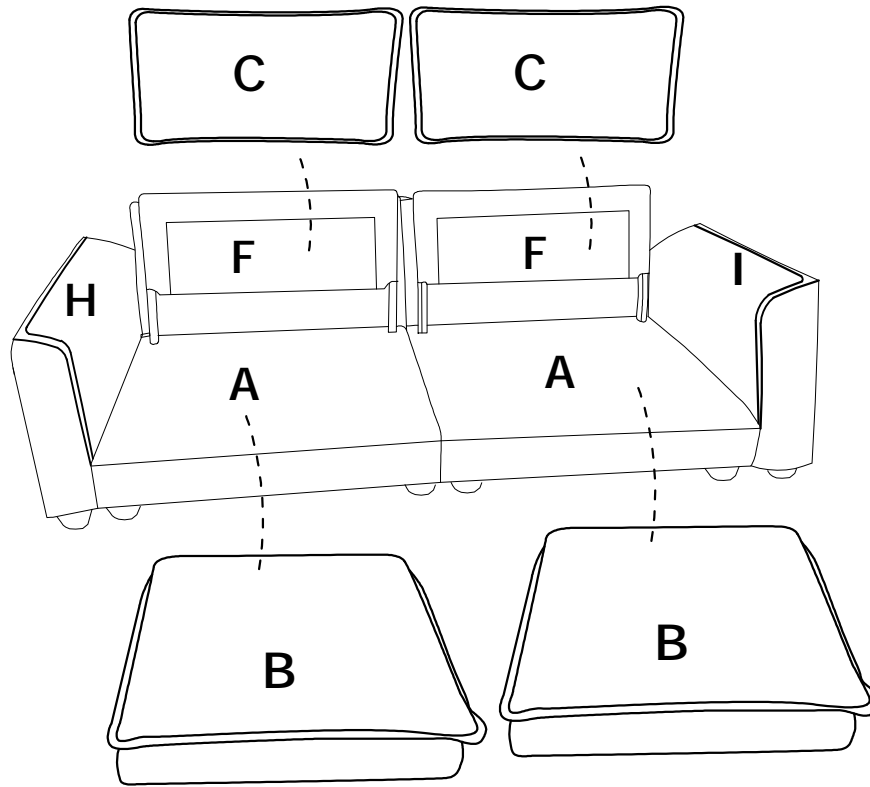



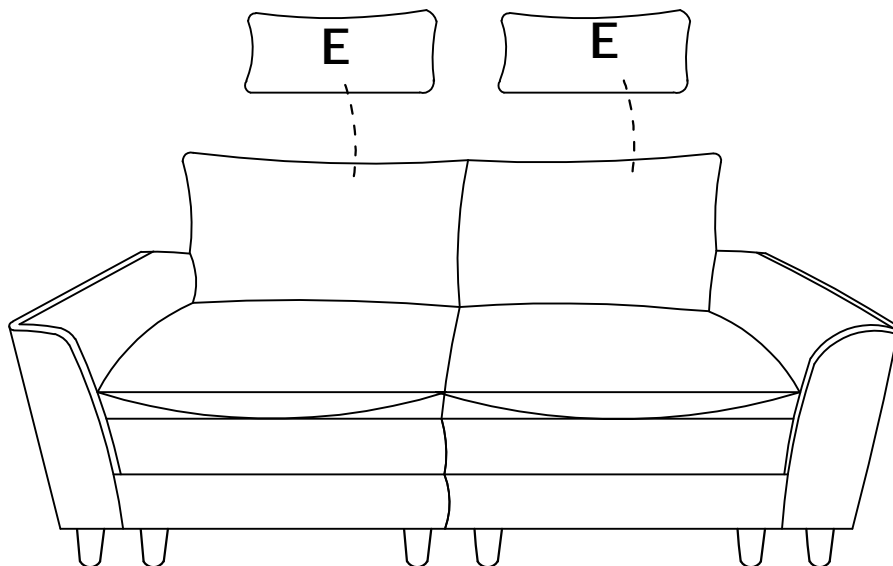





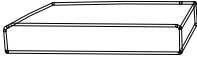

STEP 8: Place Pillows (E) on sofa and make sure it's will fitted.

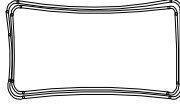

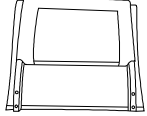

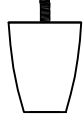

IF YOU BUY 3 SEATER SOFA

Please follow below assembly instruction

Parts List (BOX 1)x3

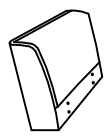
<p>A Seat frame</p>  <p>3PC</p>	<p>B Seat cushion</p>  <p>3PC</p>	<p>C Back Cushion</p>  <p>3PC</p>	<p>E Pillow</p>  <p>3PC</p>
<p>F Backrest</p>  <p>3PC</p>	<p>R Alley Key</p>  <p>3PC</p>	<p>G 9CM Leg</p>  <p>12PC</p>	<p>N Washer M8*22</p>  <p>30PCS</p>
<p>O M8*60mm Bolt</p>  <p>12PCS</p>	<p>P M8*90mm Bolt</p>  <p>9PCS</p>	<p>Q Butterfly Nut</p>  <p>9PCS</p>	

Parts List (BOX 2)x1

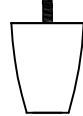
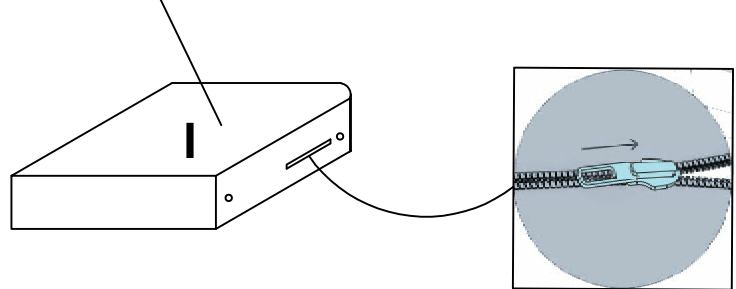
<p>H Left armrest</p>  <p>1PC</p>	<p>I Right armrest</p>  <p>1PC</p>	<p>S M8*50mm Bolt</p>  <p>8PCS</p>	<p>N Washer M8*22</p>  <p>8 PCS</p>
<p>G 9CM Leg</p>  <p>4PC</p>			

Unzip the compartment underneath the Right armrest and pull out the sofa legs.

STEP 1: Assemble the Left armrest (H) to the Seat frame (A) with Washers (N) and Bolts (S).

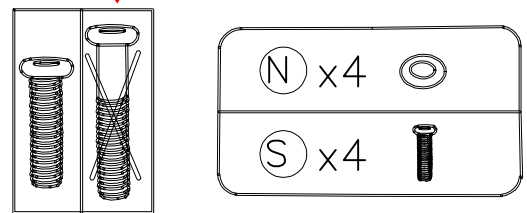
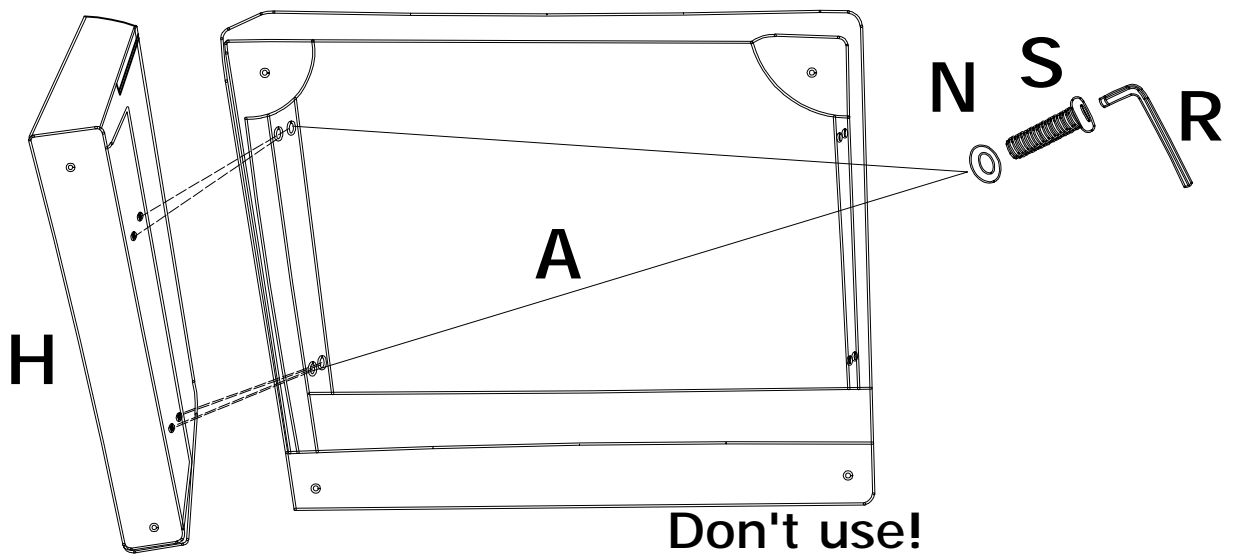

STEP 2: Assemble the Right armrest (I) to the Seat frame (A) with Washers (N) and Bolts (S).

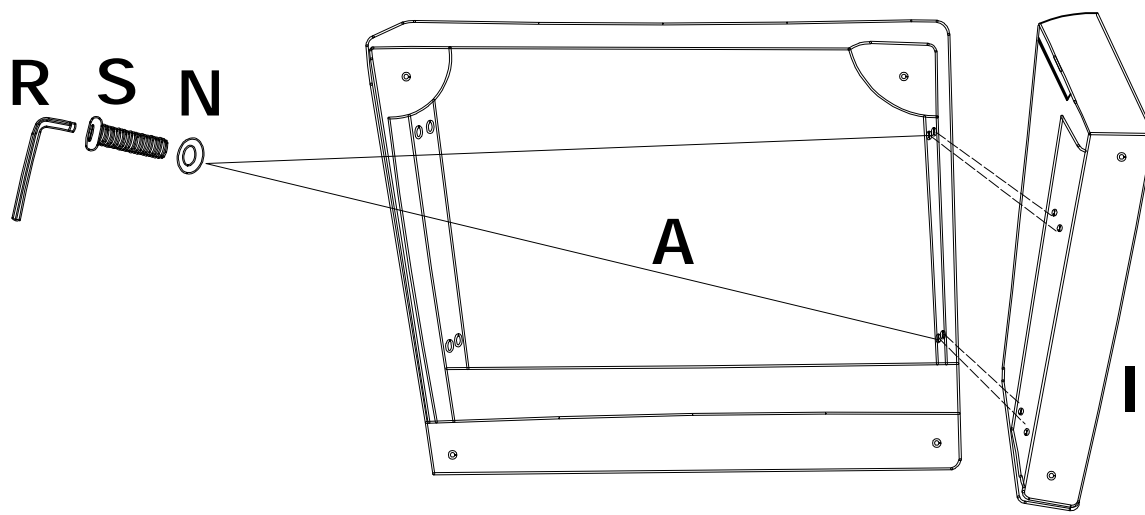

Don't use!

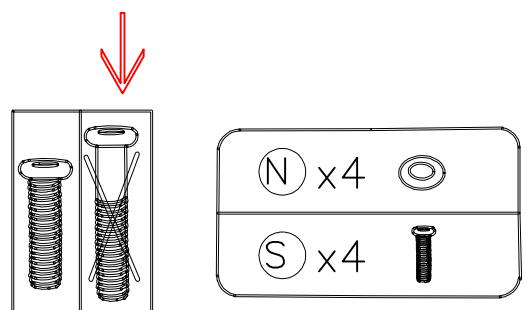

STEP 3: Assemble Seat frame (A) and Seat frame (A)with Butterfly nuts (Q) Washers (N) and Bolts (P).

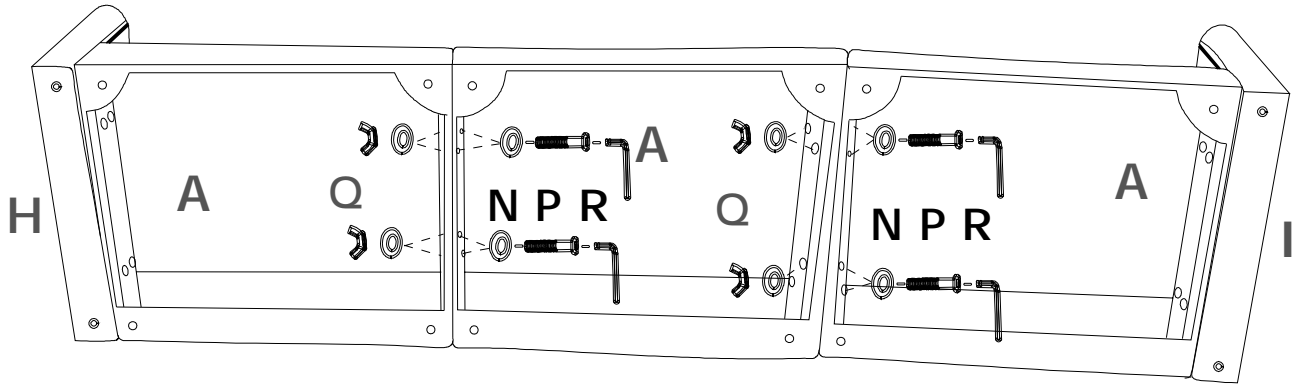

Don't use!

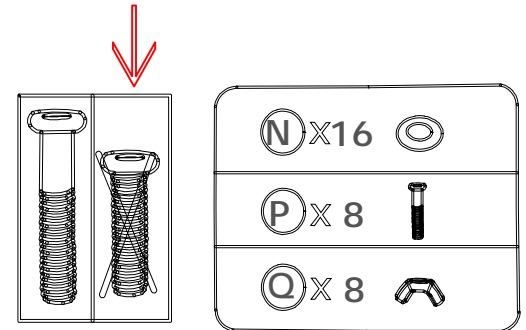

STEP 4: Assemble the Legs (G) on the sofa.

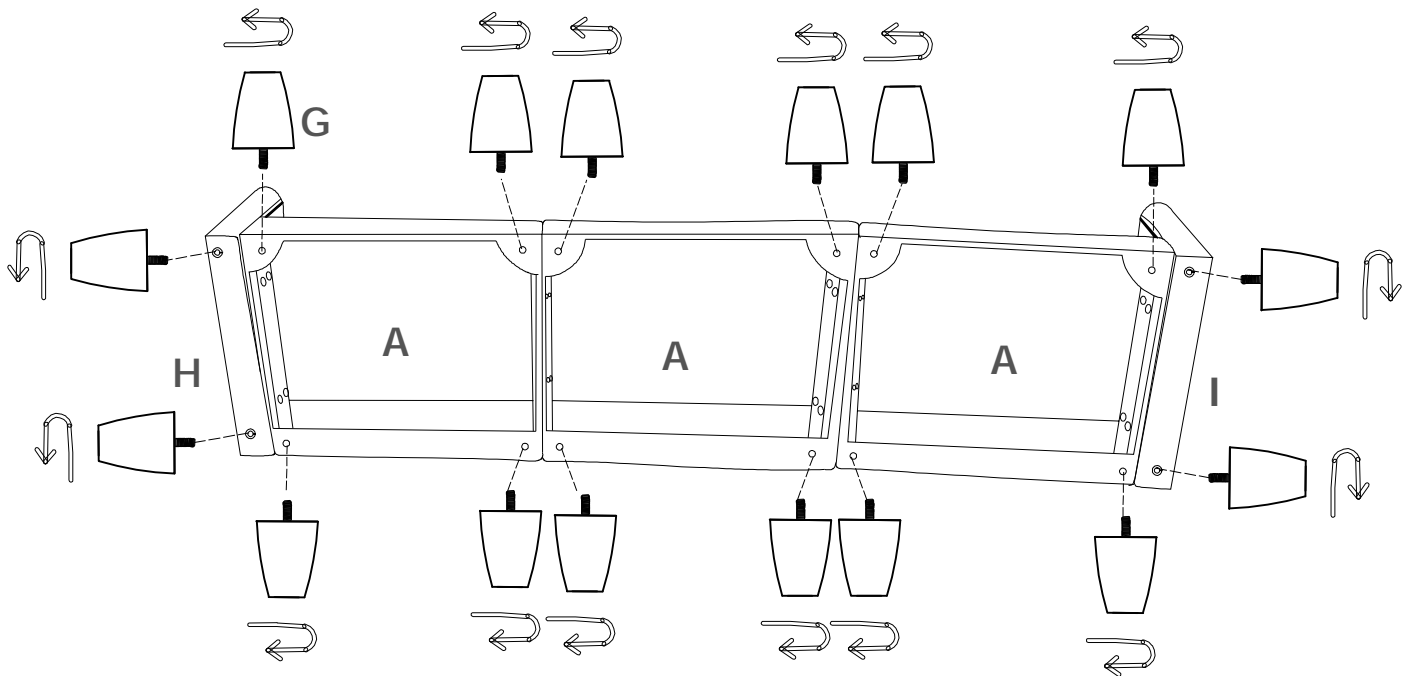

STEP 5: Insert the Backrest (F) into the designated holes, using Washer (N) and Bolts (O) to 70% tightness, and then tighten the all Bolts on the seat.

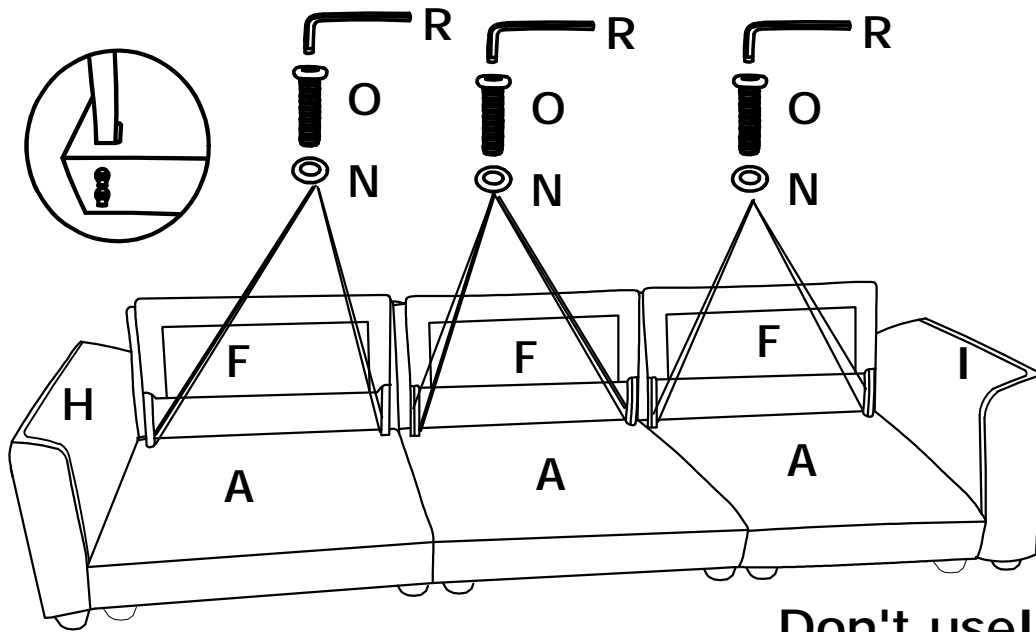

Don't use!

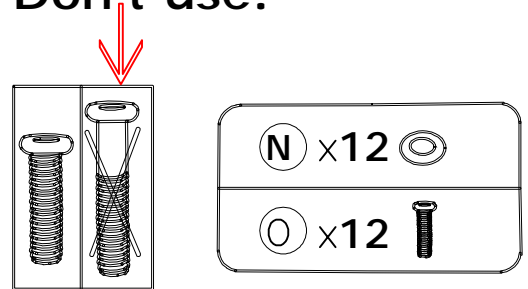

STEP 6: The cushion is packaged by vacuum compression. After cutting the package, it rebounds quickly within 4 hours. If the fabric has wrinkles, it will basically disappear after standing for 72 hours

Pat around evenly plump

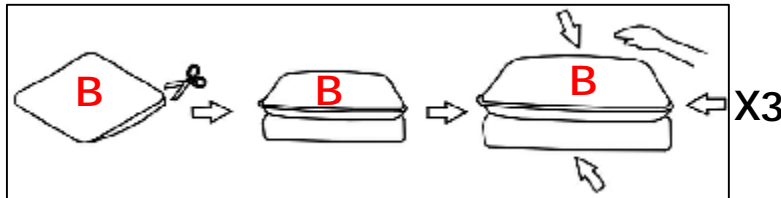

Pat around evenly plump

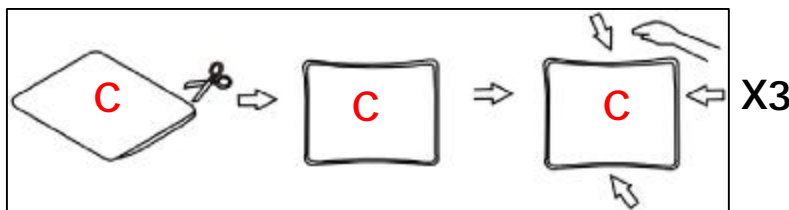

STEP 7: Place Seat cushions (B) and back cushions (C), and make sure it's will fitted.

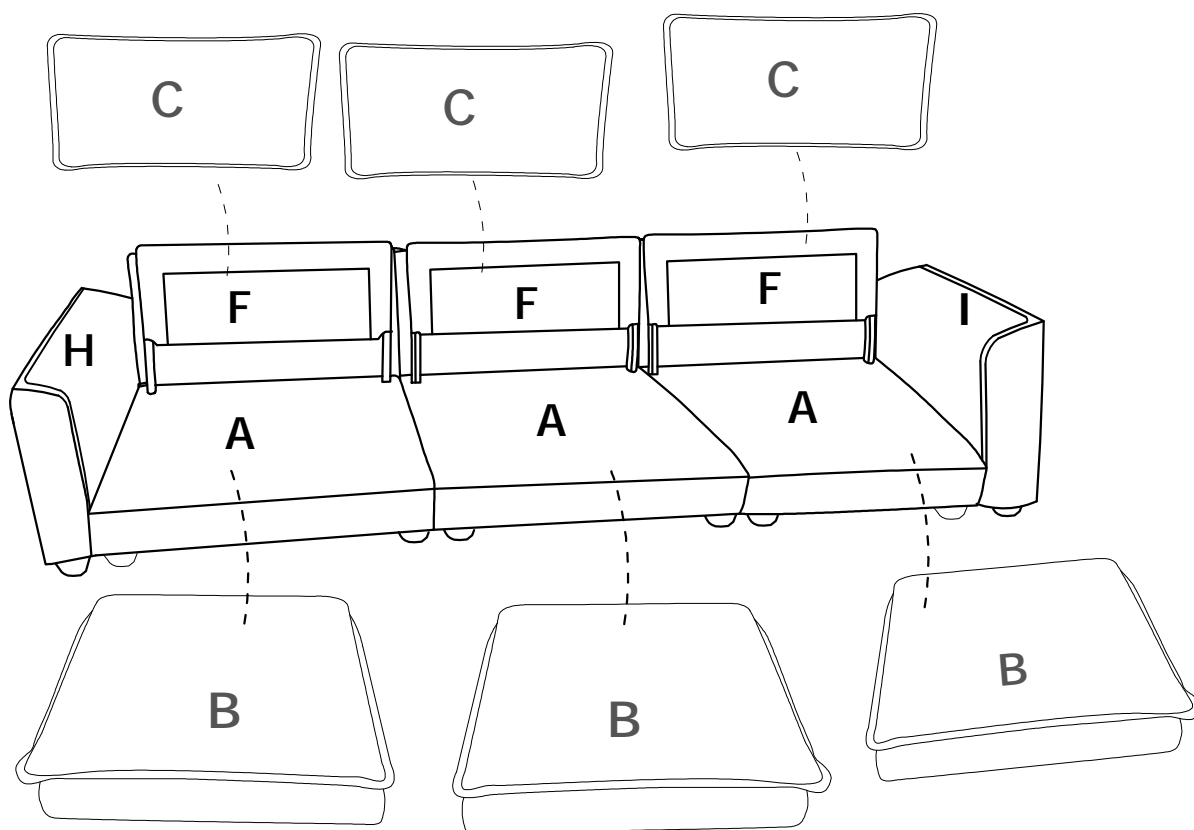



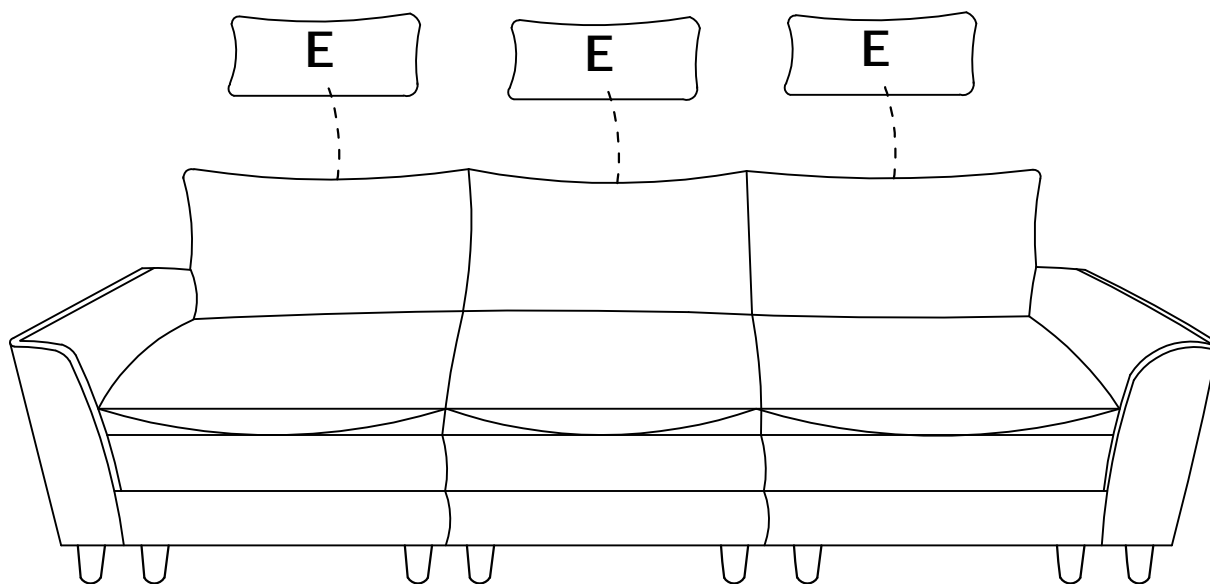





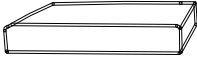

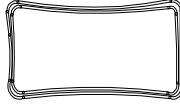
STEP 8: Place Pillows (E) on sofa and make sure it's will fitted.

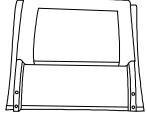

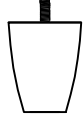



IF YOU BUY 4 SEATER SOFA
Please follow below assembly instruction

Parts List (BOX 1)x4

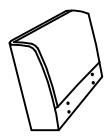
A Seat frame  4PC	B Seat cushion  4PC	C Back Cushion  4PC	E Pillow  4PC
F Backrest  4PC	R Alley Key  4PC	G 9CM Leg  16PC	N Washer M8*22  40PCS
O M8*60mm Bolt  16PCS	P M8*90mm Bolt  12PCS	Q Butterfiy Nut  12PCS	

Parts List (BOX 2)x1

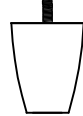
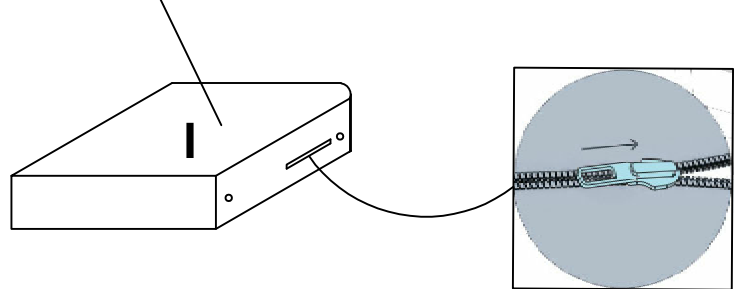
H Left armrest  1PC	I Right armrest  1PC	S M8*50mm Bolt  8PCS	N Washer M8*22  8 PCS
G 9CM Leg  4PC			

Unzip the compartment underneath the Right armrest and pull out the sofa legs.

STEP 1: Assemble the Left armrest (H) to the Seat frame (A) with Washers (N) and Bolts (S).

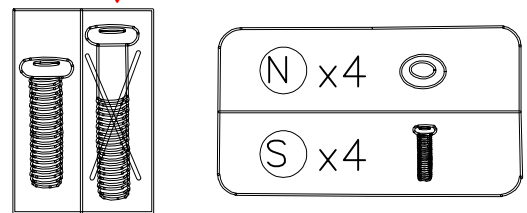
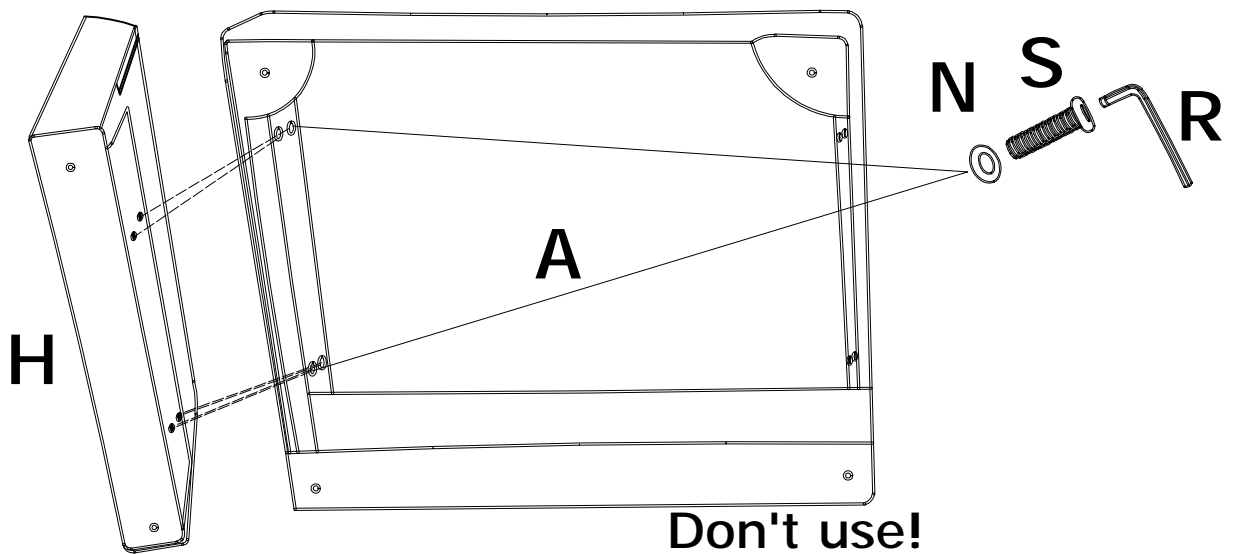

STEP 2: Assemble the Right armrest (I) to the Seat frame (A) with Washers (N) and Bolts (S).

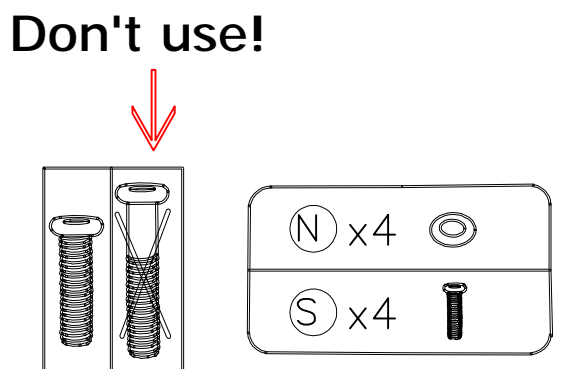
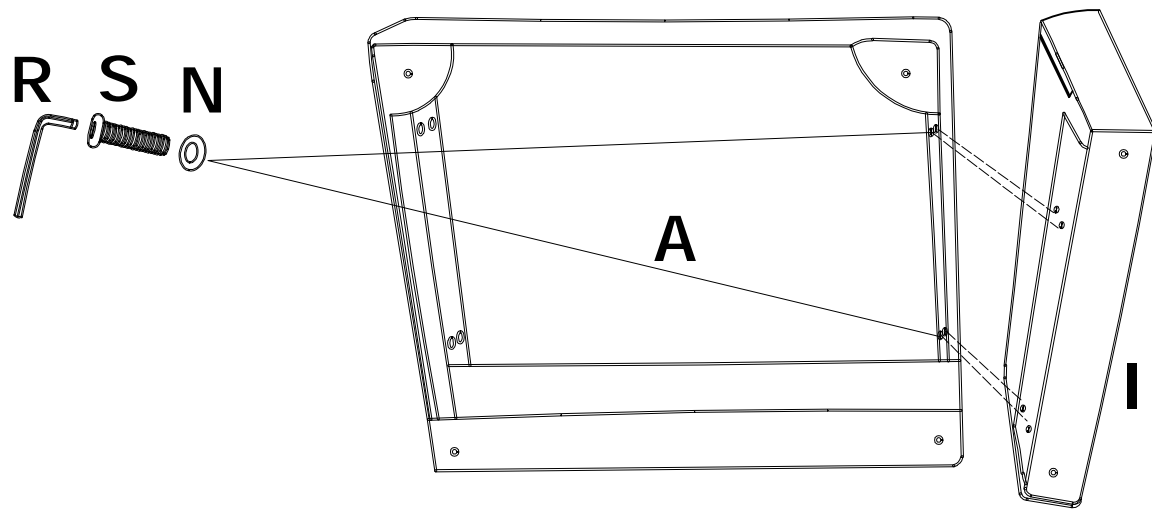

STEP 3: Assemble Seat frame (A) and Seat frame (A)with Butterfly nuts (Q) Washers (N) and Bolts (P).

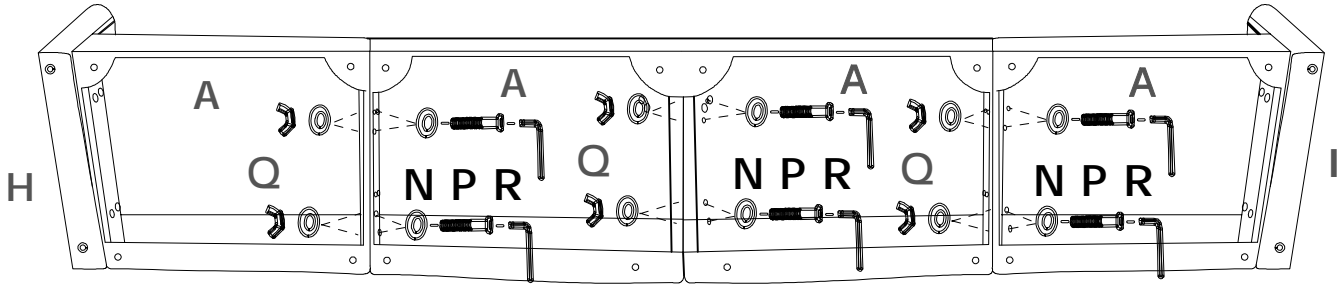

Don't use!

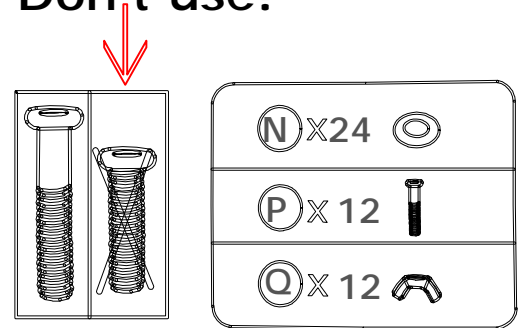

STEP 4: Assemble the Legs (G) on the sofa.

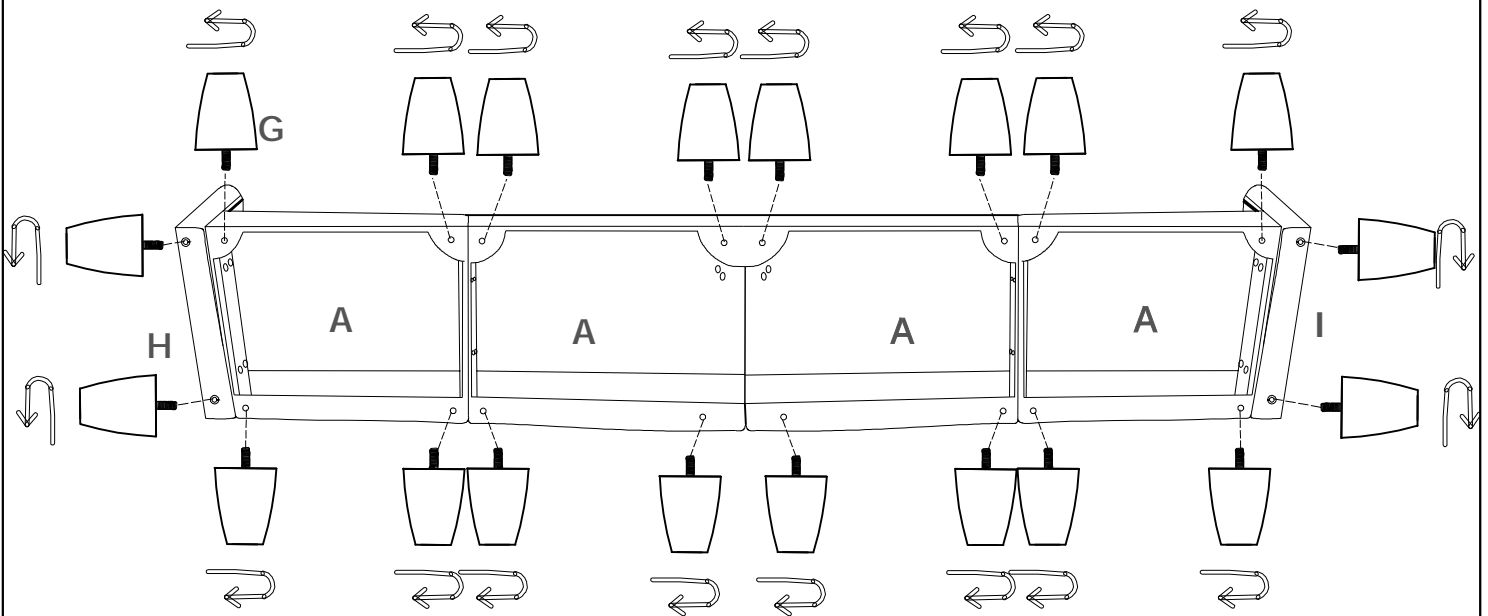

STEP 5: Insert the Backrest (F) into the designated holes, using Washer (N) and Bolts (O) to 70% tightness, and then tighten the all Bolts on the seat.

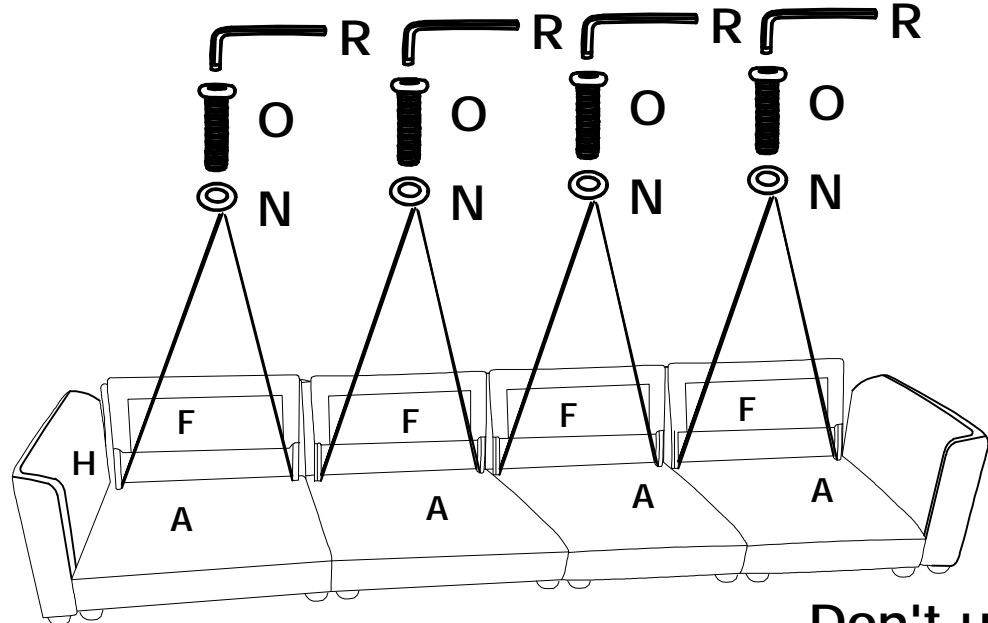

Don't use!

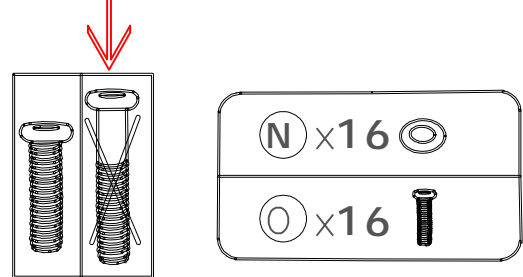

STEP 6: The cushion is packaged by vacuum compression. After cutting the package, it rebounds quickly within 4 hours. If the fabric has wrinkles, it will basically disappear after standing for 72 hours

Pat around evenly plump

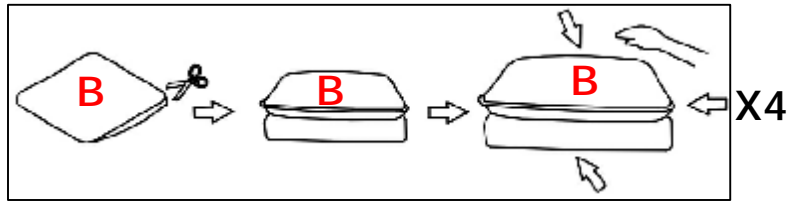

Pat around evenly plump

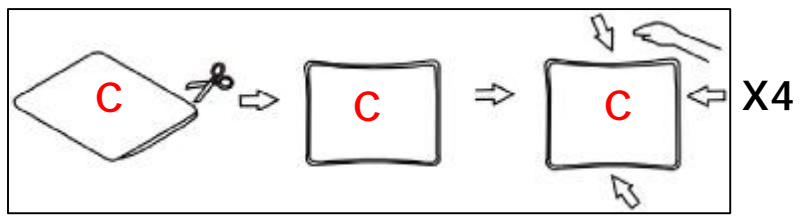

STEP 7: Place Seat cushions (B) and back cushions (C), and make sure it's will fitted.

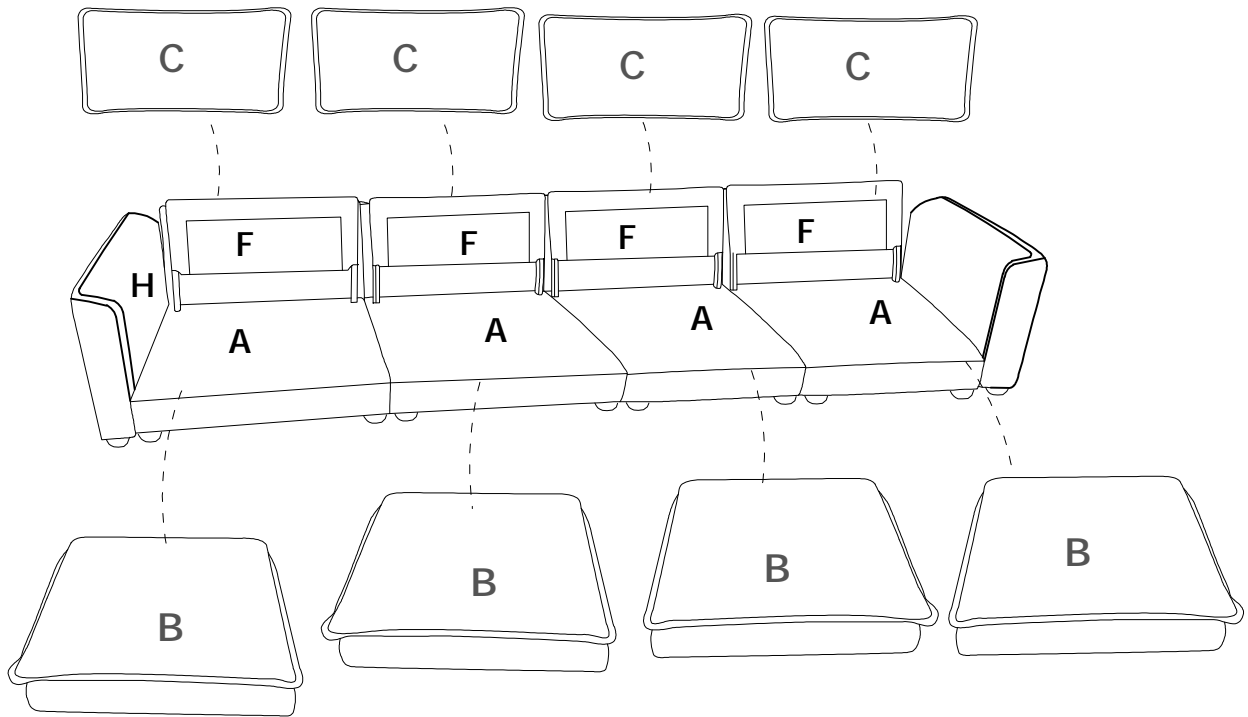

STEP 8: Place Pillows (E) on sofa and make sure it's will fitted.

