

Model: \_\_\_\_\_

Lot No: \_\_\_\_\_

Date of Purchase: \_\_\_\_\_

- 3** Fully Slot Backrest (A) into the back of the Chair Body (B), ensuring it does not move backwards or forwards.

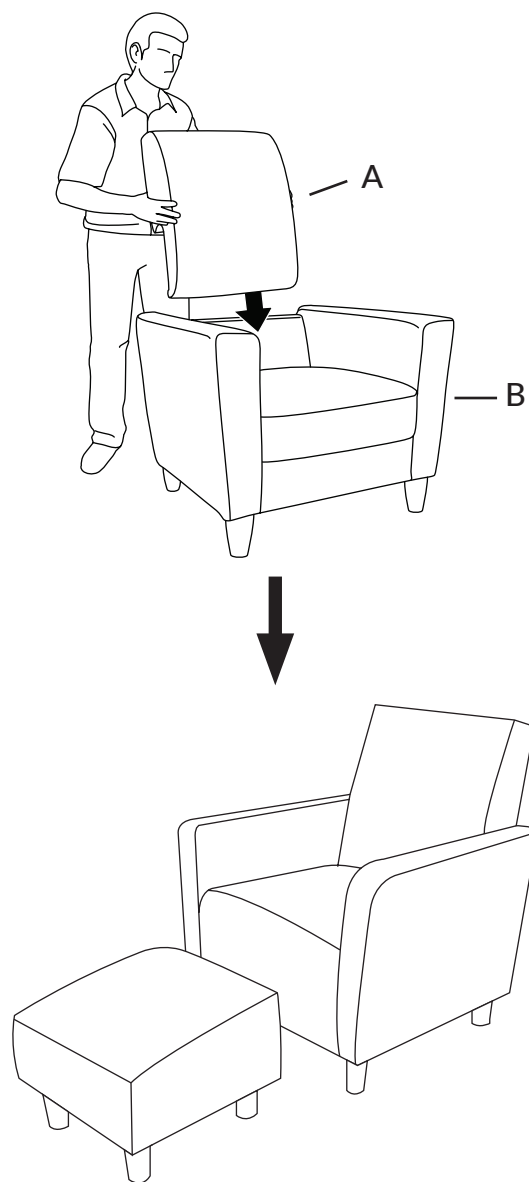

## ARM CHAIR AND OTTOMAN

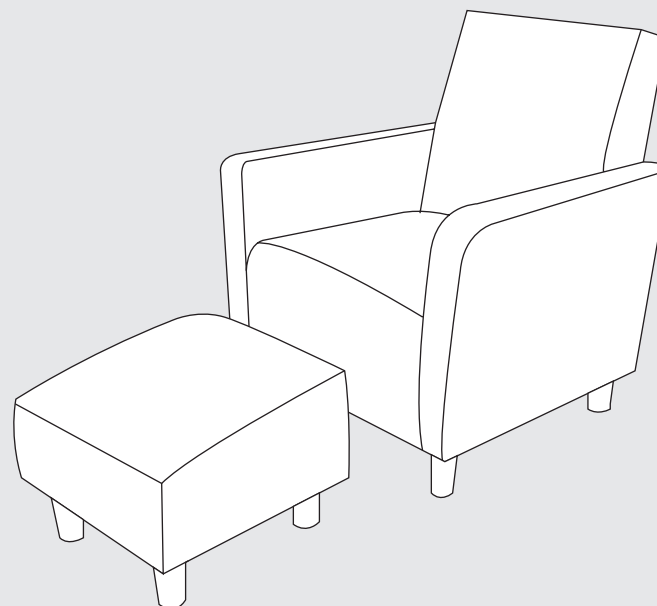

### ADULT ASSEMBLY REQUIRED

If you are missing any parts or have any questions regarding assembly, do not return this item to the retailers store. Please call our toll-free, customer service number and have this assembly manual open to the parts list ready to provide the model name, number and part name or number.



**WARNING:** This product may contain small components, please ensure they are kept away from small children.

## PARTS AND HARDWARE

Avoid using sharp objects such as a knife to cut open packing as you may accidentally damage the upholstery.

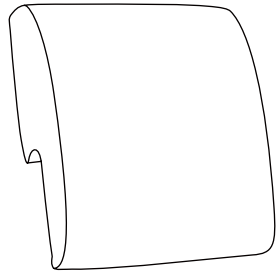

A. Backrest  
1x

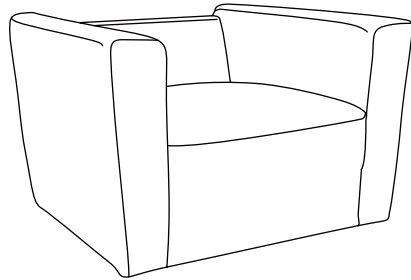

B. Chair Body  
1x

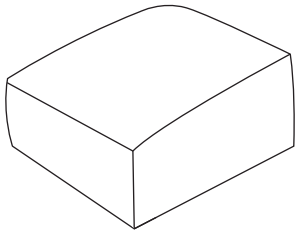

C. Ottoman Body  
1x

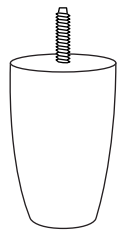

D. Legs  
8x

**NOTE: YOU WILL FIND THE OTTOMAN BODY (C) AND LEGS (D) INSIDE THE ZIPPERED COMPARTMENT ON THE BOTTOM OF THE CHAIR BODY (B).**

## ASSEMBLY INSTRUCTIONS

Do not fully tighten bolts until assembly is complete.

- 1** Turn Chair Body (B) on back. Attach each Leg (D) to Chair Body (B) by hand turning threaded post into insert nut.

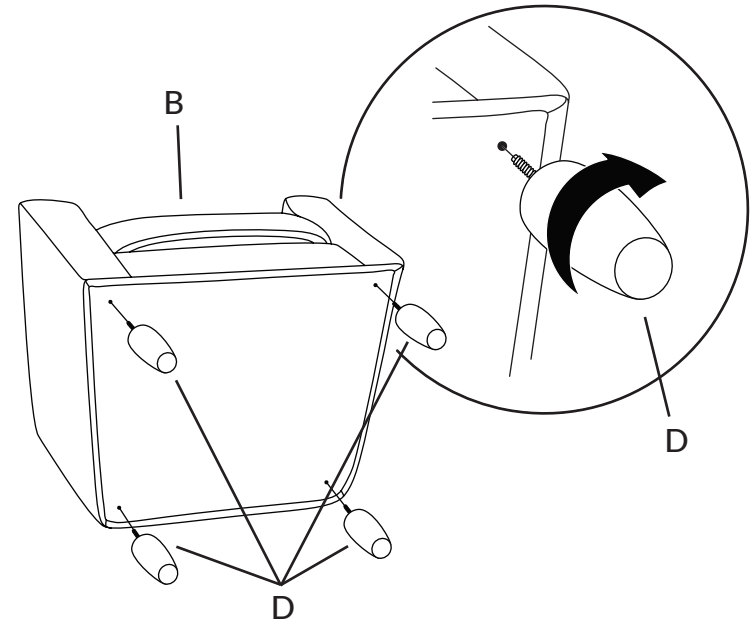

- 2** Turn Ottoman Body (C) on back. Attach each Leg (D) to Ottoman Body (C) by hand turning threaded post into insert nut.

