

ASSEMBLY INSTRUCTIONS

66" Wide Convertible Sofa Bed
with Side Storage

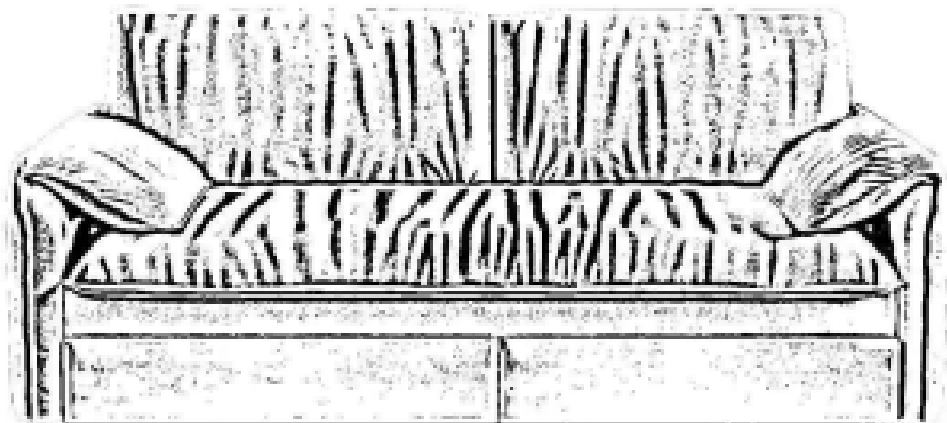

ASSEMBLY INSTRUCTIONS

Thank you for purchasing this quality product, Be sure to check all packing material carefully for small part that may have come loose inside the carton during shipment.



DO NOT RETURN TO THE STORE!

If parts are missing or damaged, we will gladly ship your replacements parts free of charge.

CAUTION:

Do not fully tighten bolts/nuts until product fully assembled. Keep all hardware out of reach of children.

NOTICE

1. Always use proper tools.
2. Follow the assembly steps in order. Do not skip any steps.
3. Periodically check to ensure that all connectors (bolts, screws, etc.) are tight.
4. Keep the instructions for future reference.
5. Check to ensure all "PARTS" and "HARDWARE" quantities, as noted as enclosed prior to commencement of assembly.
6. Place all furniture parts on a clean and flat soft surface to prevent any scratches possible.
7. Where assembly instructions state that the assembly requires two or more people, do not attempt by yourself as there is a risk of injury.
8. If you need any assistance with your new item or if you are missing any parts. Please email us your inquiries .





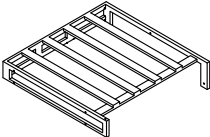
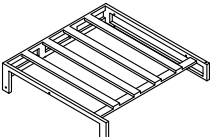
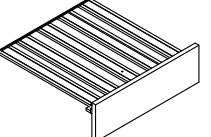
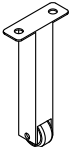
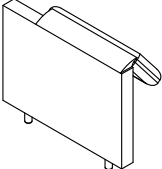
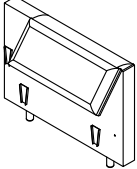
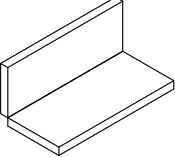
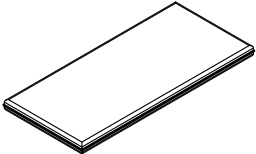
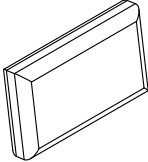

We will be happy to assist and walk you through your assembly process.

9. Since the dimensions of our products are manually measured, there may be an error of ± 0.79 inch between the real product and the measurement data. The measurement data is for reference only.

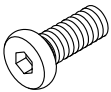
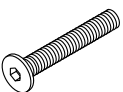
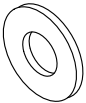
PART LIST:

<p>①</p>  <p>1PC</p>	<p>②</p>  <p>1PC</p>	<p>③</p>  <p>2PCS</p>	<p>④</p>  <p>4PCS</p>
<p>⑤</p>  <p>1PC</p>	<p>⑥</p>  <p>1PC</p>	<p>⑦</p>  <p>1PC</p>	<p>⑧</p>  <p>1PC</p>
<p>⑨</p>  <p>2PCS</p>			

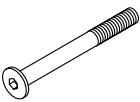
HARDWARE LIST:

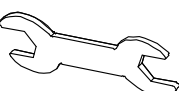
<p>A</p>  <p>M8×20 16 PCS</p>	<p>B</p>  <p>M8×55 5PCS</p>	<p>C</p>  <p>22PCS</p>	<p>D</p>  <p>17PCS</p>
<p>E</p>  <p>2PCS</p>	<p>F</p>  <p>1PC</p>	<p>G</p>  <p>6PCS</p>	<p>H</p>  <p>M8×80 2PCS</p>
<p>I</p>  <p>M8×30 12PCS</p>	<p>J</p>  <p>1PC</p>		

Step 1

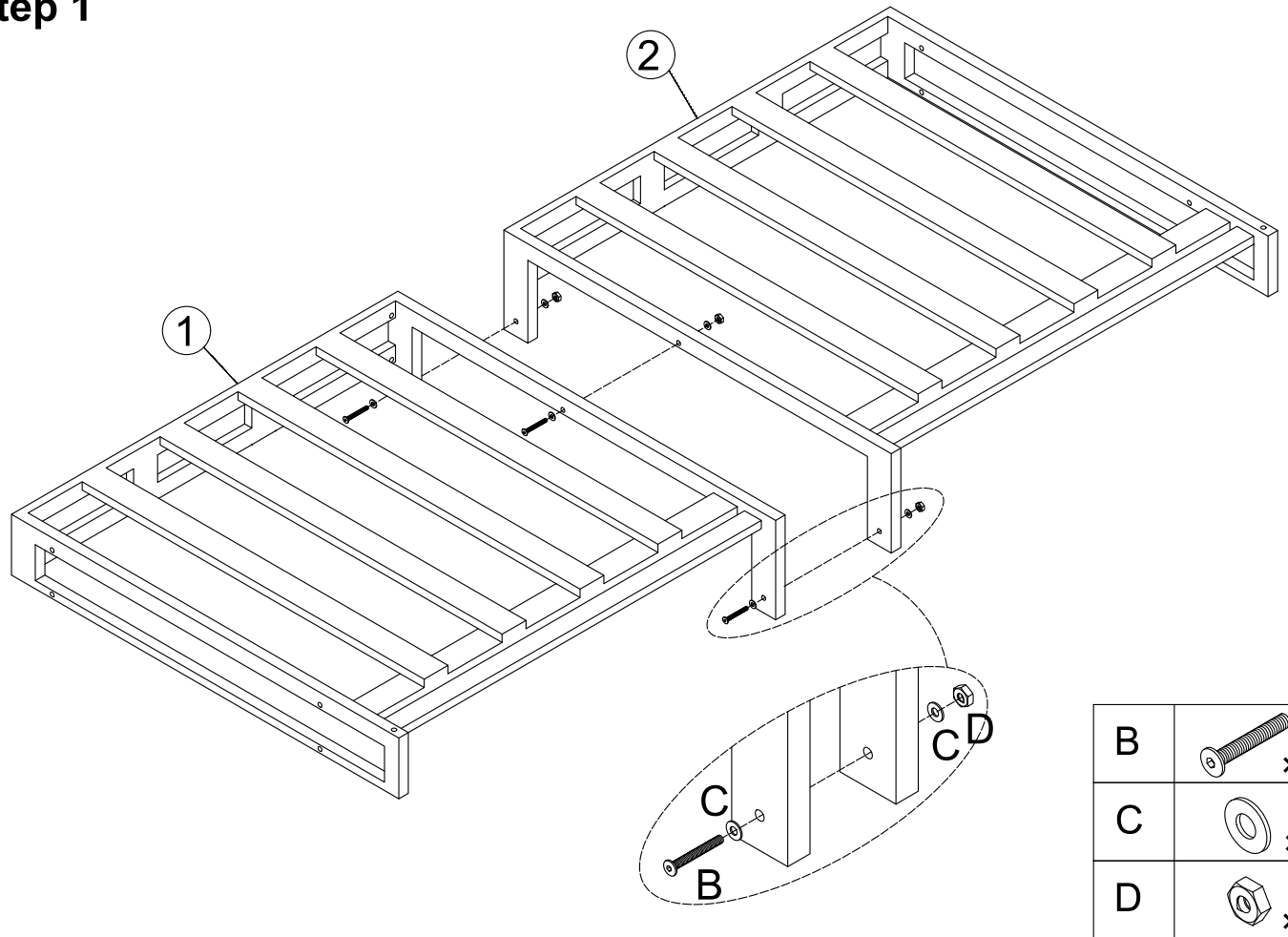

Step 2

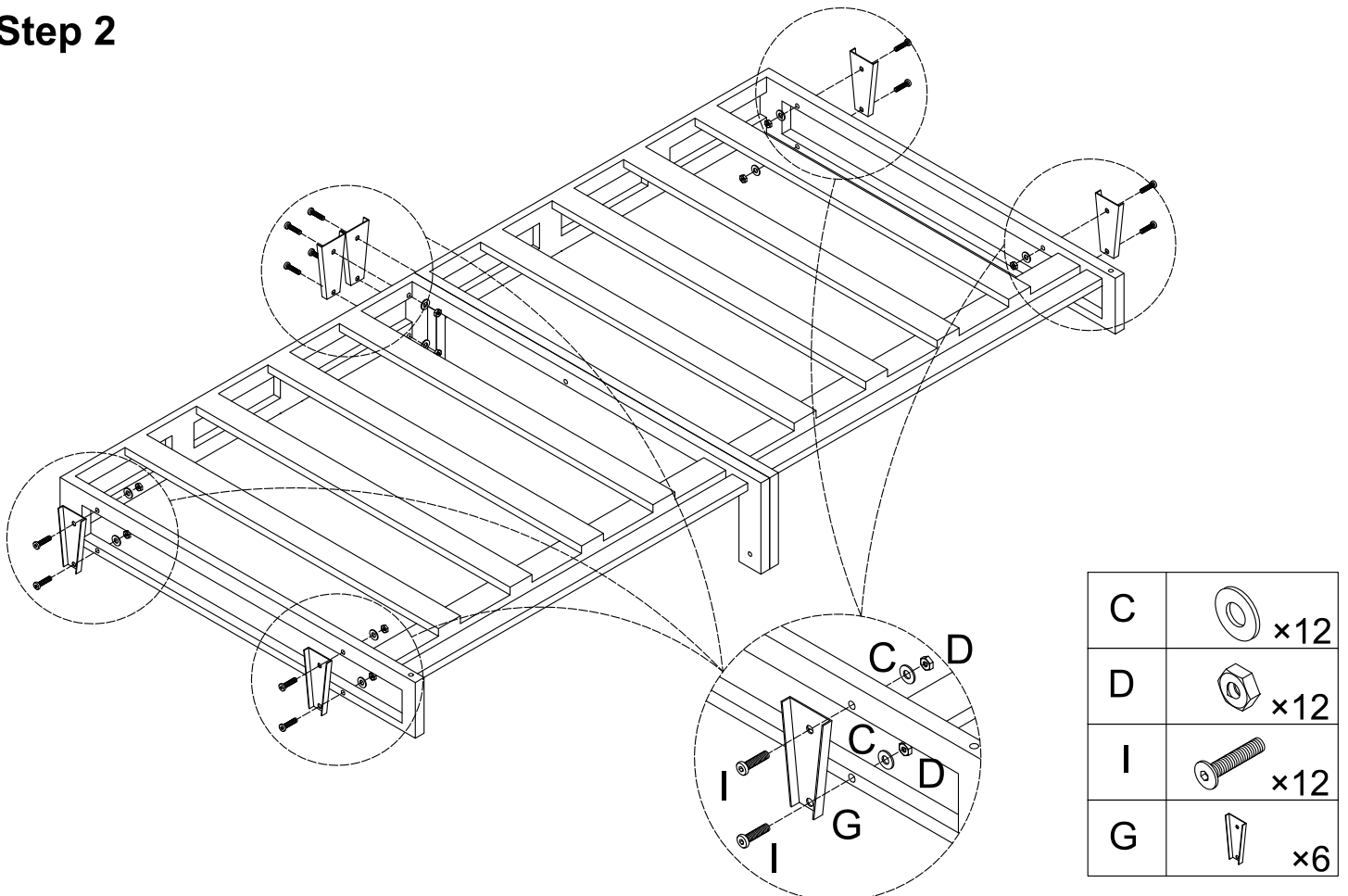

Step 3

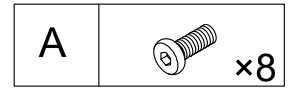
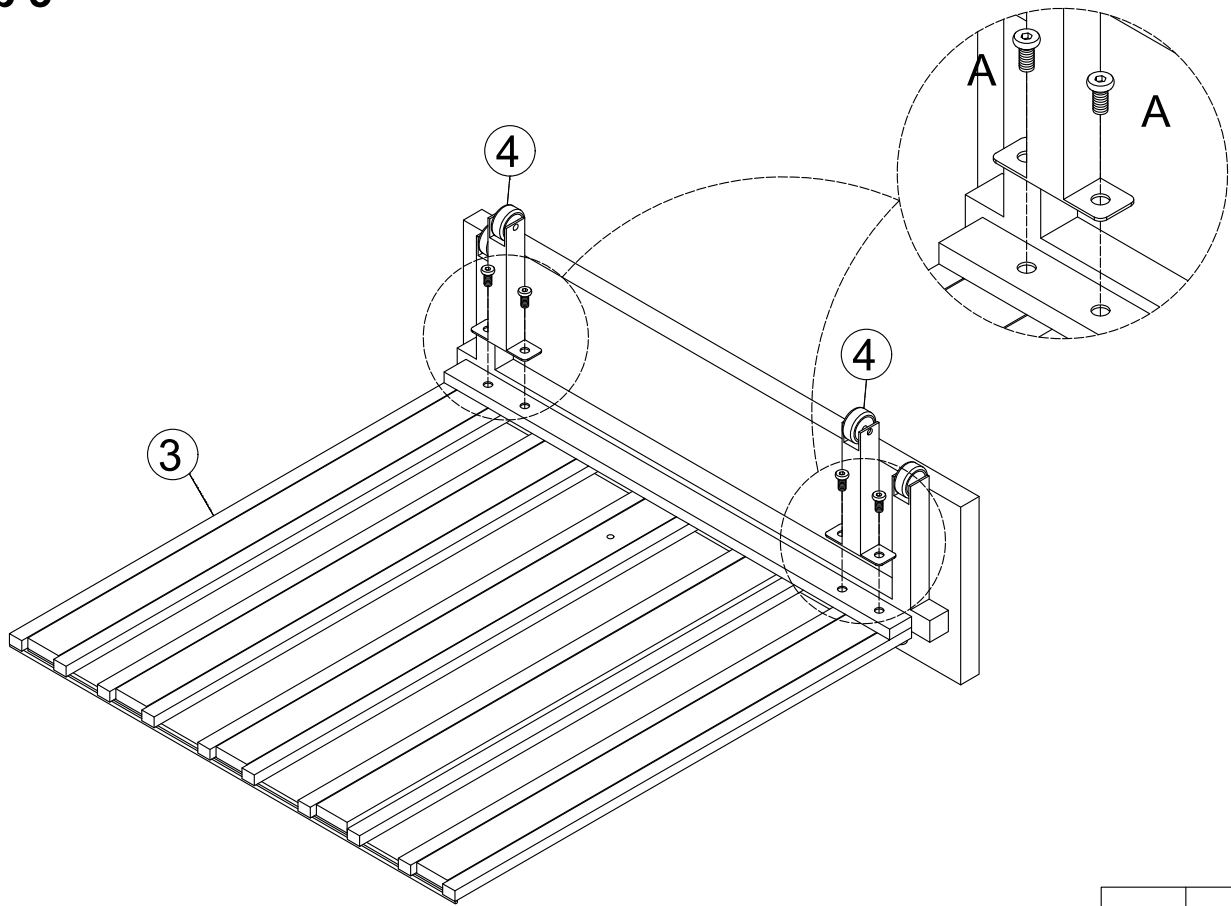

Step 4

