

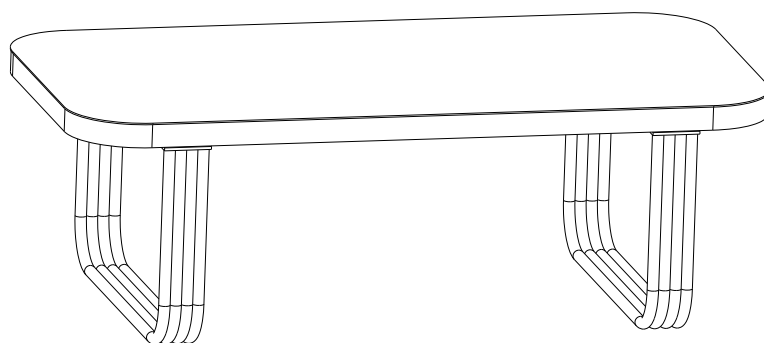

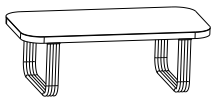

# Aluminium Coffee Table



**Read the instructions before use of this product.**

Please keep this instruction manual for future reference.

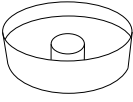
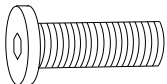
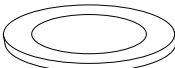

PARST & HARDWARE LIST			
Part	Part Image	Description	Qty
A		Table Top	1
B		Table Leg	2
C		Allen Wrench	1
D		Nut Cap	8
E		Bolt M6*20	8
F		Washer	8

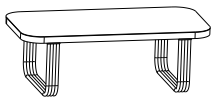

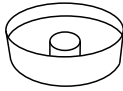
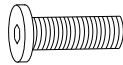
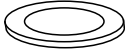
EXTRA			
Part	Part Image	Description	Qty
D		Nut Cap	1
E		Bolt M6*20	1
F		Washer	1

**ATTENTION:**

Keep children away during assembly. This item contains small parts that can be dangerous for children. Children should always be under direct adult supervision while using this product.

Do not discard any of the packaging until you have checked that you have all of the parts and fittings required.

Carefully remove the contents from the package. If any parts are missing, do not attempt to use the product until they have been obtained.

Make sure that each bolt needed for all steps matches the corresponding figure ensure proper assembly.

Step 1: Attach table legs (B) to table top (A) using bolts (E), washers (F) and nut caps (D).

NOTE: Please fully tighten all bolts at this time.

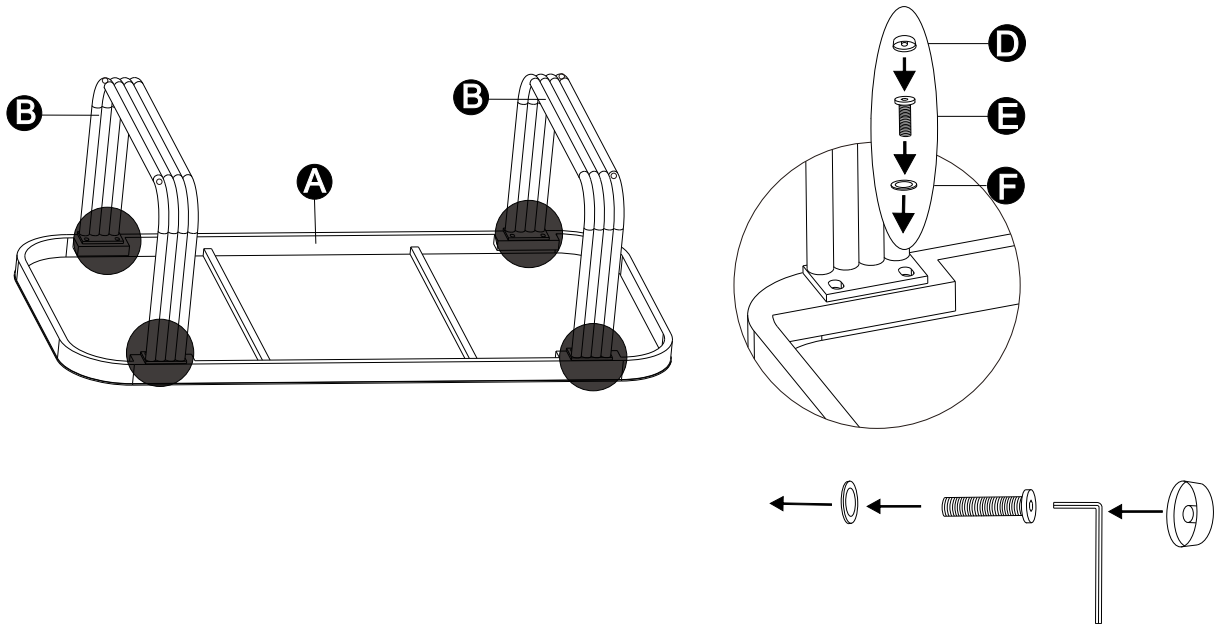

Step 2: Carefully turn assembled unit upright on a flat surface.

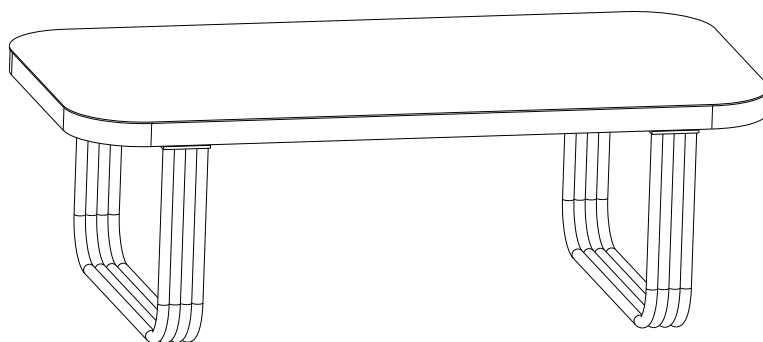

## Cleaning and Maintenance

Clean frame with mild soapy water, rinse thoroughly. Dry frame parts completely. Do not use bleach, acid, or other solvents on the fabric and metal parts. We recommend the use of furniture covers to protect the Arm Chiar when not in use.

Inspect and tighten all bolts on a regular basis to ensure proper performance and safety.

In order to prolong the life and beauty of your coffee table, we recommend storing it in a dry and protective area during off season periods.